

Excellent Integrated System Limited

Stocking Distributor

Click to view price, real time Inventory, Delivery & Lifecycle Information:

[Molex Connector Corporation](#)

[0210200825](#)

For any questions, you can email us directly:

sales@integrated-circuit.com

0.50MM CENTER FFC JUMPER CABLE (LOW TEMPERATURE) CHART

'A' DIM.	1.18±.079 INCHES 30±2.00 MM		2+.079 INCHES 51±2.00 MM		3+.118 INCHES 76±3.00 MM		4+.118 INCHES 102±3.00 MM		5+.157 INCHES 127±4.00 MM		6+.157 INCHES 152±4.00 MM		7+.157 INCHES 178±4.00 MM		8+.157 INCHES 203±4.00 MM		9+.197 INCHES 229±5.00 MM		10+.197 INCHES 254±5.00 MM		12+.197 INCHES 305±5.00 MM	
	TYPE 'D'	TYPE 'A'	TYPE 'D'	TYPE 'A'	TYPE 'D'	TYPE 'A'	TYPE 'D'	TYPE 'A'	TYPE 'D'	TYPE 'A'	TYPE 'D'	TYPE 'A'	TYPE 'D'	TYPE 'A'	TYPE 'D'	TYPE 'A'	TYPE 'D'	TYPE 'A'	TYPE 'D'	TYPE 'A'	TYPE 'D'	TYPE 'A'
BACKER	TYPE 'D'	TYPE 'A'	TYPE 'D'	TYPE 'A'	TYPE 'D'	TYPE 'A'	TYPE 'D'	TYPE 'A'	TYPE 'D'	TYPE 'A'	TYPE 'D'	TYPE 'A'	TYPE 'D'	TYPE 'A'	TYPE 'D'	TYPE 'A'	TYPE 'D'	TYPE 'A'	TYPE 'D'	TYPE 'A'	TYPE 'D'	TYPE 'A'
CKTS: 7	210200744	210200745	210200746	210200747	210200748	210200749	210200750	210200751	210200752	210200753	210200754	210200755	210200756	210200757	210200758	210200759	210200760	210200761	210200762	210200763	210200764	210200765
CKTS: 9	210200766	210200767	210200768	210200769	210200770	210200771	210200772	210200773	210200774	210200775	210200776	210200777	210200778	210200779	210200780	210200781	210200782	210200783	210200784	210200785	210200786	210200787
CKTS: 11	210200788	210200789	210200790	210200791	210200792	210200793	210200794	210200795	210200796	210200797	210200798	210200799	210200800	210200801	210200802	210200803	210200804	210200805	210200806	210200807	210200808	210200809
CKTS: 13	210200810	210200811	210200812	210200813	210200814	210200815	210200816	210200817	210200818	210200819	210200820	210200821	210200822	210200823	210200824	210200825	210200826	210200827	210200828	210200829	210200830	210200831
CKTS: 15	210200832	210200833	210200834	210200835	210200836	210200837	210200838	210200839	210200840	210200841	210200842	210200843	210200844	210200845	210200846	210200847	210200848	210200849	210200850	210200851	210200852	210200853
CKTS: 17	210200854	210200855	210200856	210200857	210200858	210200859	210200860	210200861	210200862	210200863	210200864	210200865	210200866	210200867	210200868	210200869	210200870	210200871	210200872	210200873	210200874	210200875
CKTS: 19	210200876	210200877	210200878	210200879	210200880	210200881	210200882	210200883	210200884	210200885	210200886	210200887	210200888	210200889	210200890	210200891	210200892	210200893	210200894	210200895	210200896	210200897
CKTS: 21	210200898	210200899	210200900	210200901	210200902	210200903	210200904	210200905	210200906	210200907	210200908	210200909	210200910	210200911	210200912	210200913	210200914	210200915	210200916	210200917	210200918	210200919
CKTS: 23	210200920	210200921	210200922	210200923	210200924	210200925	210200926	210200927	210200928	210200929	210200930	210200931	210200932	210200933	210200934	210200935	210200936	210200937	210200938	210200939	210200940	210200941
CKTS: 25	210200942	210200943	210200944	210200945	210200946	210200947	210200948	210200949	210200950	210200951	210200952	210200953	210200954	210200955	210200956	210200957	210200958	210200959	210200960	210200961	210200962	210200963
CKTS: 27	210200964	210200965	210200966	210200967	210200968	210200969	210200970	210200971	210200972	210200973	210200974	210200975	210200976	210200977	210200978	210200979	210200980	210200981	210200982	210200983	210200984	210200985
CKTS: 29	210200986	210200987	210200988	210200989	210200990	210200991	210200992	210200993	210200994	210200995	210200996	210200997	210200998	210200999	210201000	210201001	210201002	210201003	210201004	210201005	210201006	210201007
CKTS: 31	210201008	210201009	210201010	210201011	210201012	210201013	210201014	210201015	210201016	210201017	210201018	210201019	210201020	210201021	210201022	210201023	210201024	210201025	210201026	210201027	210201028	210201029
CKTS: 33	210201030	210201031	210201032	210201033	210201034	210201035	210201036	210201037	210201038	210201039	210201040	210201041	210201042	210201043	210201044	210201045	210201046	210201047	210201048	210201049	210201050	210201051
CKTS: 35	210201052	210201053	210201054	210201055	210201056	210201057	210201058	210201059	210201060	210201061	210201062	210201063	210201064	210201065	210201066	210201067	210201068	210201069	210201070	210201071	210201072	210201073
CKTS: 37	210201074	210201075	210201076	210201077	210201078	210201079	210201080	210201081	210201082	210201083	210201084	210201085	210201086	210201087	210201088	210201089	210201090	210201091	210201092	210201093	210201094	210201095
CKTS: 39	210201096	210201097	210201098	210201099	210201100	210201101	210201102	210201103	210201104	210201105	210201106	210201107	210201108	210201109	210201110	210201111	210201112	210201113	210201114	210201115	210201116	210201117

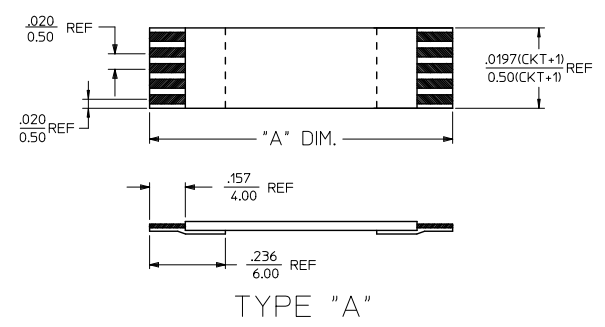

NOTES:
1. NO PRINTING ON JUMPER CABLE UNLESS OTHERWISE SPECIFIED, IF PRINTING IS REQUIRED THEN IT WOULD BE CONSIDERED A SPECIAL JUMPER CABLE.

MADE DIMS REFERENCE IEC NO: USW2012-0078 DRAWN/MIG 2011/10/18 CHKD: APPR:SFULLON 2011/11/02 DESCRIPTION	QUALITY SYMBOLS	GENERAL TOLERANCES (UNLESS SPECIFIED)	SCALE	DESIGN UNITS	THIRD ANGLE PROJECTION	REVISE ON CAD ONLY
	0 0	mm INCH 4 PLACES ± --- ± --- 3 PLACES ± --- ± --- 2 PLACES ± 0.13 ± --- 1 PLACE ± 0.25 ± --- ANGULAR ± 1°	DIMENSION STYLE MM/IN	INCH	TITLE 0.50MM CENTER FFC JUMPER CABLE (LOW TEMPERATURE) CHART	
	DRAFT WHERE APPLICABLE MUST REMAIN WITHIN DIMENSIONS	APPROVED BY R. MACK	DATE 02/02/28	MATERIAL NO. SEE CHART	DOCUMENT NO. SD-21020-002	SHEET NO. 1 OF 1
	THIS DRAWING CONTAINS INFORMATION THAT IS PROPRIETARY TO MOLEX INCORPORATED AND SHOULD NOT BE USED WITHOUT WRITTEN PERMISSION					