

## **Excellent Integrated System Limited**

Stocking Distributor

Click to view price, real time Inventory, Delivery & Lifecycle Information:

[Lite-On, Inc.](#)  
[LTP-3363CKR-P](#)

For any questions, you can email us directly:  
[sales@integrated-circuit.com](mailto:sales@integrated-circuit.com)



**LITE-ON TECHNOLOGY CORPORATION**

Property of Lite-On Only

**LED DISPLAY**

**LTP-3363CKR-P**  
**DATA SHEET**

<b><u>ITEM</u></b>	<b><u>Description</u></b>	<b><u>By</u></b>	<b><u>DATE</u></b>
1	New Spec	Reo Lin	2011/07/15



# LITE-ON TECHNOLOGY CORPORATION

Property of Lite-On Only

## FEATURES

- \* 0.3 inch (7.62 mm) DIGIT HEIGHT
- \* CONTINUOUS UNIFORM SEGMENTS
- \* LOW POWER REQUIREMENT
- \* EXCELLENT CHARACTERS APPEARANCE
- \* HIGH BRIGHTNESS & HIGH CONTRAST
- \* WIDE VIEWING ANGLE
- \* SOLID STATE RELIABILITY
- \* CATEGORIZED FOR LUMINOUS INTENSITY
- \* SMD DISPLAY
- \* LEAD-FREE PACKAGE (ACCORDING TO RoHS)

## DESCRIPTION

The LTP-3363CKR-P is a 0.3 inch (7.62 mm) digit height dual digit 17-segment alphanumeric display. This device uses AS-AllnGaP SUPER RED LED chips (AllnGaP epi on GaAs substrate). The display has black face and white segments.

## DEVICE

PART NO.	DESCRIPTION
AllnGaP RED	Multiplex Common Cathode Rt. Hand Decimal
LTP-3363CKR-P	



**LITE-ON TECHNOLOGY CORPORATION**

Property of Lite-On Only

**PACKAGE DIMENSIONS**

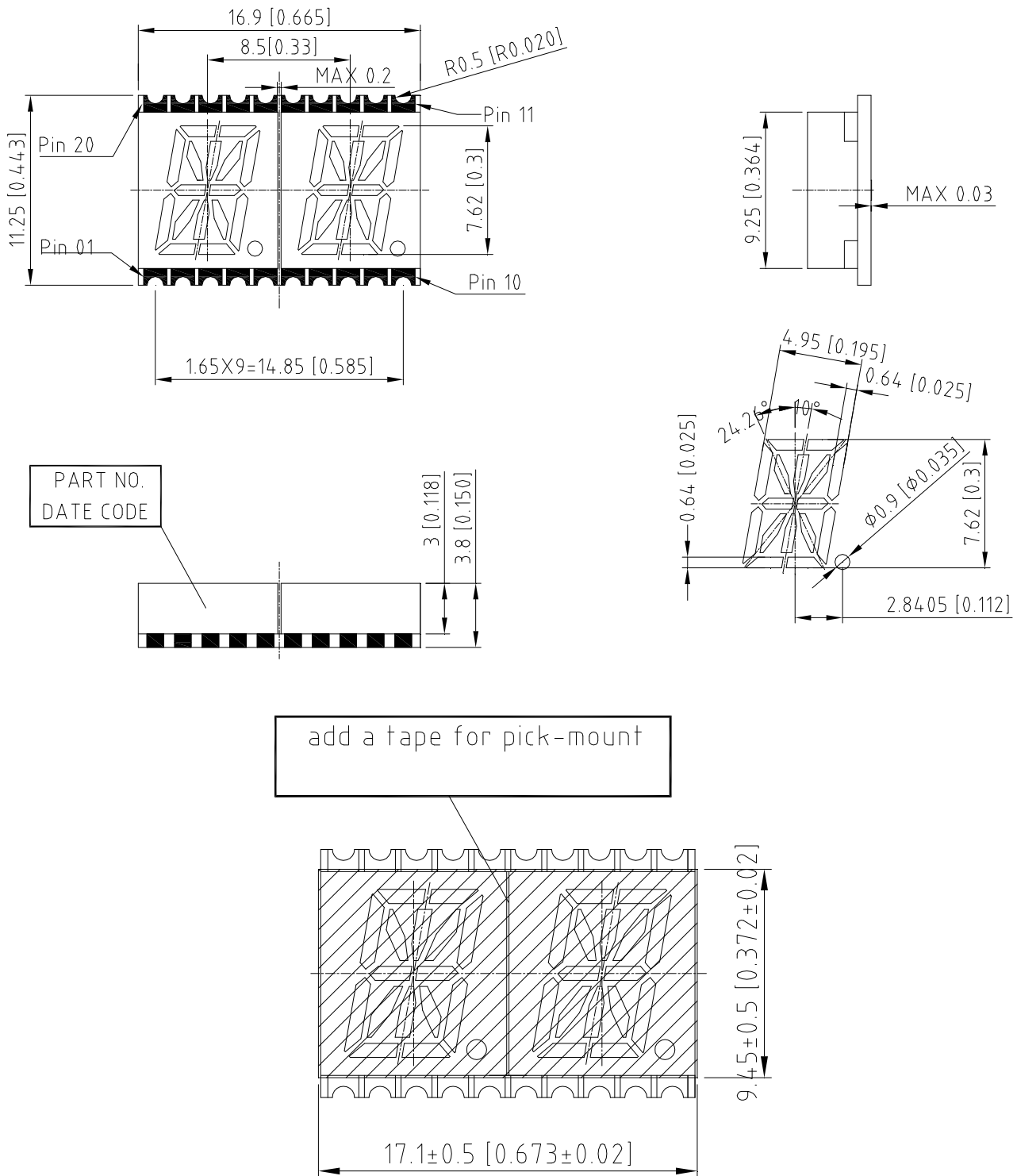

NOTES: 1. All dimensions are in millimeters. Tolerances are  $\pm 0.25\text{mm}$  (0.01") unless otherwise noted.



**LITE-ON TECHNOLOGY CORPORATION**

Property of Lite-On Only

**INTERNAL CIRCUIT DIAGRAM**

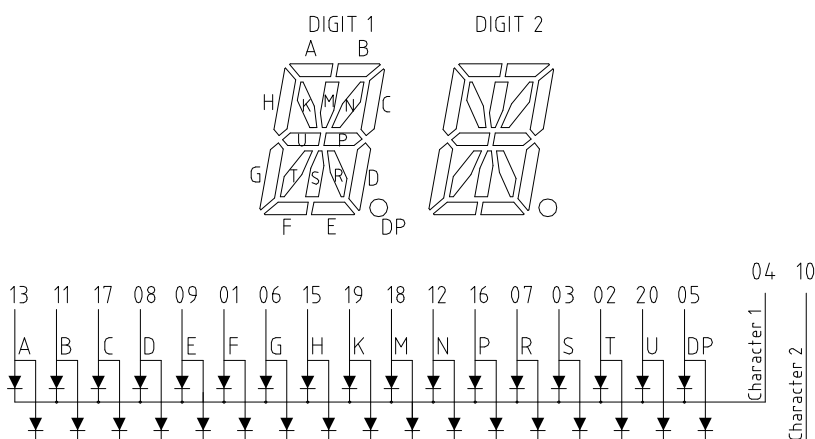

**PIN CONNECTION**

No.	CONNECTION
1	ANODE F
2	ANODE T
3	ANODE S
4	COMMON CATHODE (Digit 1)
5	ANODE DP
6	ANODE G
7	ANODE R
8	ANODE D
9	ANODE E
10	COMMON CATHODE (Digit 2)
11	ANODE B
12	ANODE N
13	ANODE A
14	NO CONNECTION
15	ANODE H
16	ANODE P
17	ANODE C
18	ANODE M
19	ANODE K
20	ANODE U



# LITE-ON TECHNOLOGY CORPORATION

Property of Lite-On Only

## ABSOLUTE MAXIMUM RATING

PARAMETER	MAXIMUM RATING	UNIT
Power Dissipation Per Segment	70	mW
Peak Forward Current Per Segment ( Frequency 1Khz, 18% duty cycle)	90	mA
Continuous Forward Current Per Segment	25	mA
Forward Current Derating from 25 <sup>0</sup> C	0.27	mA/ <sup>0</sup> C
Operating Temperature Range	-35 <sup>0</sup> C to +105 <sup>0</sup> C	
Storage Temperature Range	-35 <sup>0</sup> C to +105 <sup>0</sup> C	
Soldering Conditions : 1/16 inch below seating plane for 3 seconds at 260 <sup>0</sup> C		

## ELECTRICAL / OPTICAL CHARACTERISTICS

PARAMETER	SYMBOL	MIN.	TYP.	MAX.	UNIT	TEST CONDITION
Average Luminous Intensity Per Segment	I <sub>v</sub>	T.B.D	T.B.D		μcd	I <sub>F</sub> =1mA
			T.B.D			I <sub>F</sub> =10mA
Peak Emission Wavelength	λ <sub>p</sub>		639		nm	I <sub>F</sub> =20mA
Spectral Line Half-Width	Δλ		20		nm	I <sub>F</sub> =20mA
Dominant Wavelength	λ <sub>d</sub>		631		nm	I <sub>F</sub> =20mA
Forward Voltage Per Segment	V <sub>F</sub>		2.0	2.6	V	I <sub>F</sub> =20mA
Reverse Current Per Segment	I <sub>R</sub>			100	μA	V <sub>R</sub> =5V
Luminous Intensity Matching Ratio	I <sub>v</sub> -m			2:1		I <sub>F</sub> =1mA

Note: Luminous intensity is measured with a light sensor and filter combination that approximates the CIE (Commision Internationale De L'Eclairage) eye-response curve.



**LITE-ON TECHNOLOGY CORPORATION**

Property of Lite-On Only

**TYPICAL ELECTRICAL / OPTICAL CHARACTERISTIC CURVES**

(25°C Ambient Temperature Unless Otherwise Noted)

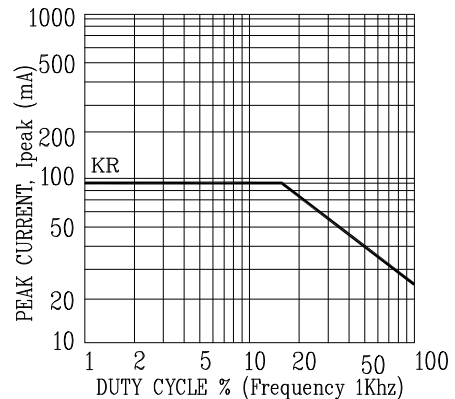
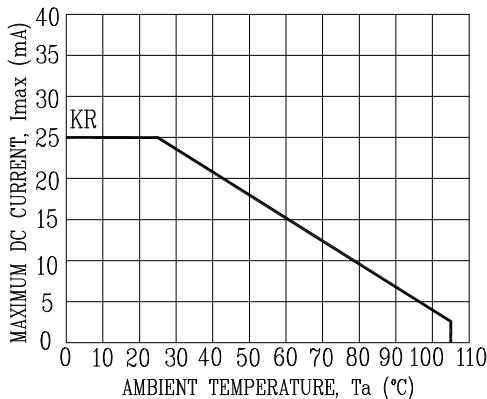
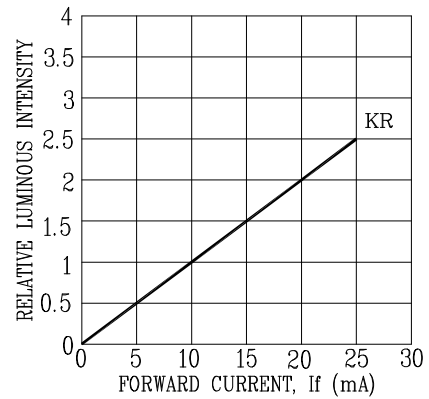
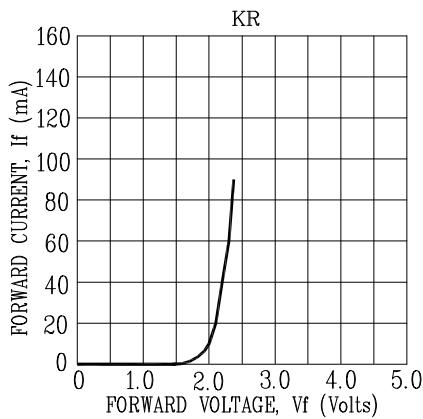
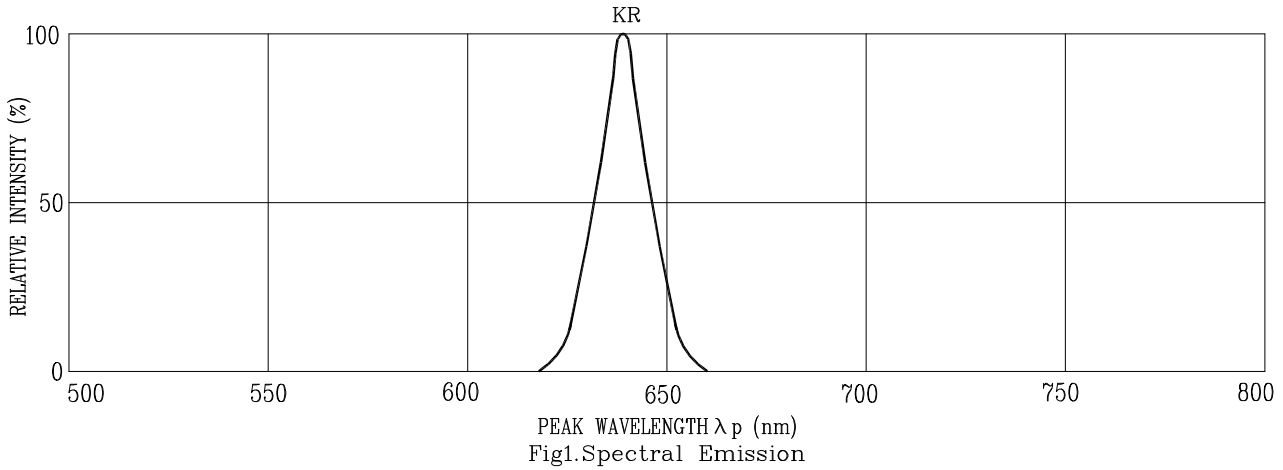



**LITE-ON TECHNOLOGY CORPORATION**

Property of Lite-On Only

**SMT SOLDERING INSTRUCTION**

(Number of reflow process shall be less than 2 times, and cooling process to normal temperature is required between the first and the second soldering process)

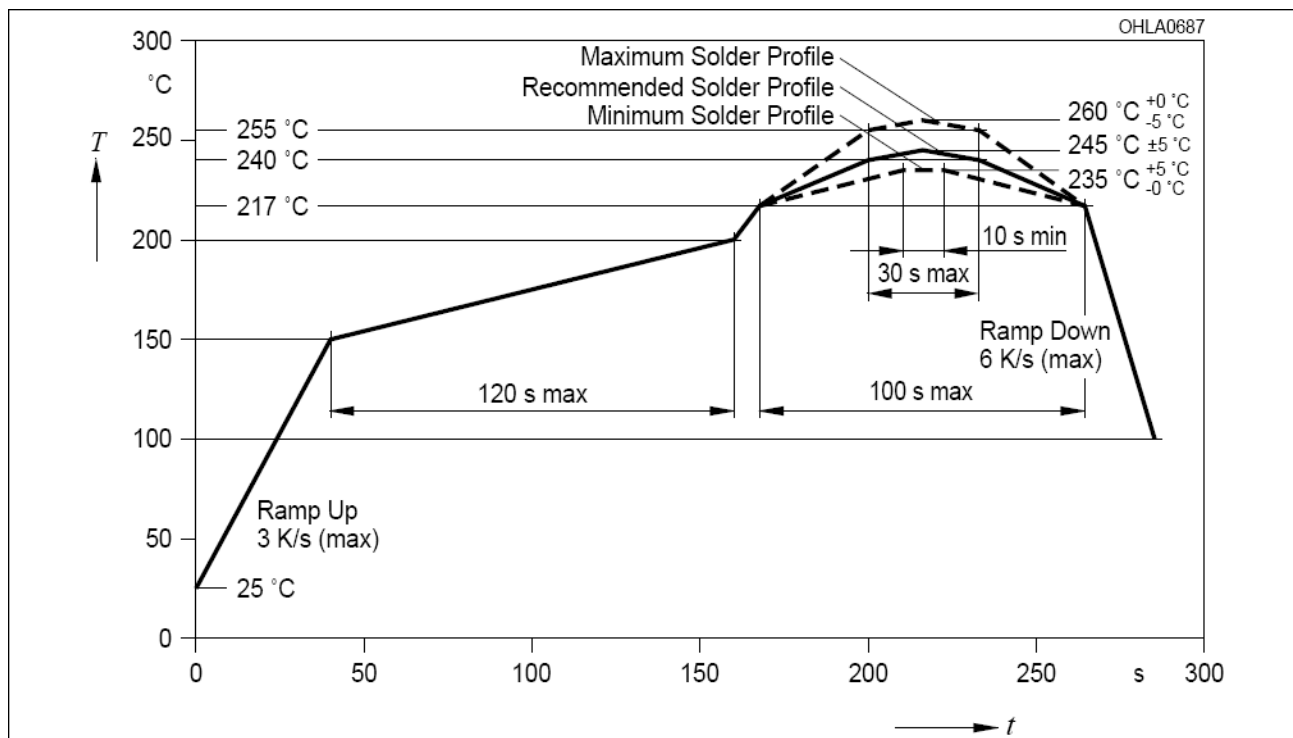

Note:

1. Recommended soldering condition:

Reflow Soldering (Two times only)		Soldering Iron (One time only)	
Pre-heat:	120~150°C.	Temperature	300°C Max.
Pre-heat time:	120sec. Max.	Soldering time	3sec. Max.
Peak temperature:	260°C Max.		
Soldering time:	5sec. Max.		

2. Number of reflow process shall be less than 2 times, and cooling process to normal temperature is required between the first and the second soldering process.





**LITE-ON TECHNOLOGY CORPORATION**

Property of Lite-On Only

**RECOMMENDED SOLDERING PATTERN (UNIT: mm)**

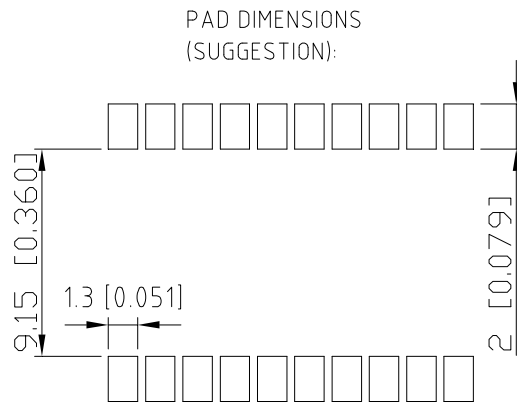

**PACKING MODE**

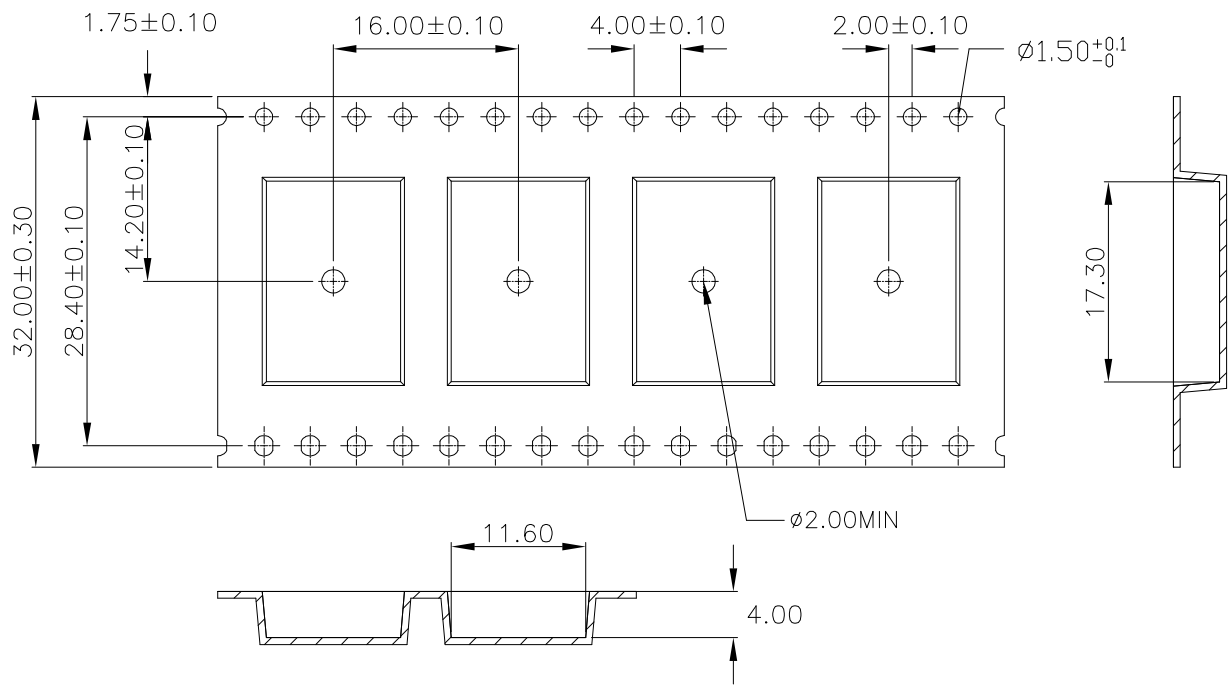



**LITE-ON TECHNOLOGY CORPORATION**

Property of Lite-On Only

**PACKING REEL DIMENSIONS**

NOTE : packing qty 950 PCS/REEL

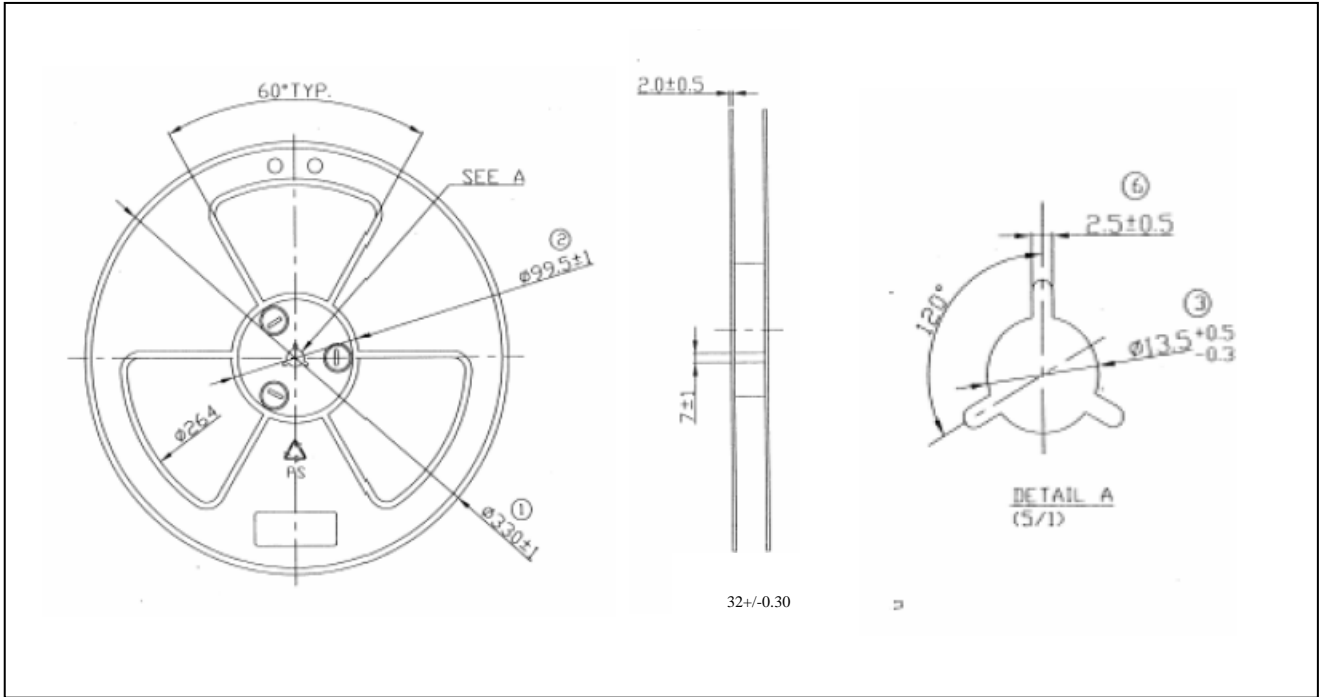

**LITEON** LITE-ON TECHNOLOGY CORPORATION  
 Property of Lite-On Only

**Moisture Proof Packaging**

All N/D SMD displays are shipped in moisture proof package. The displays should be stored at 30°C or less and 90% RH or less. Once the package opened, moisture absorption begins.

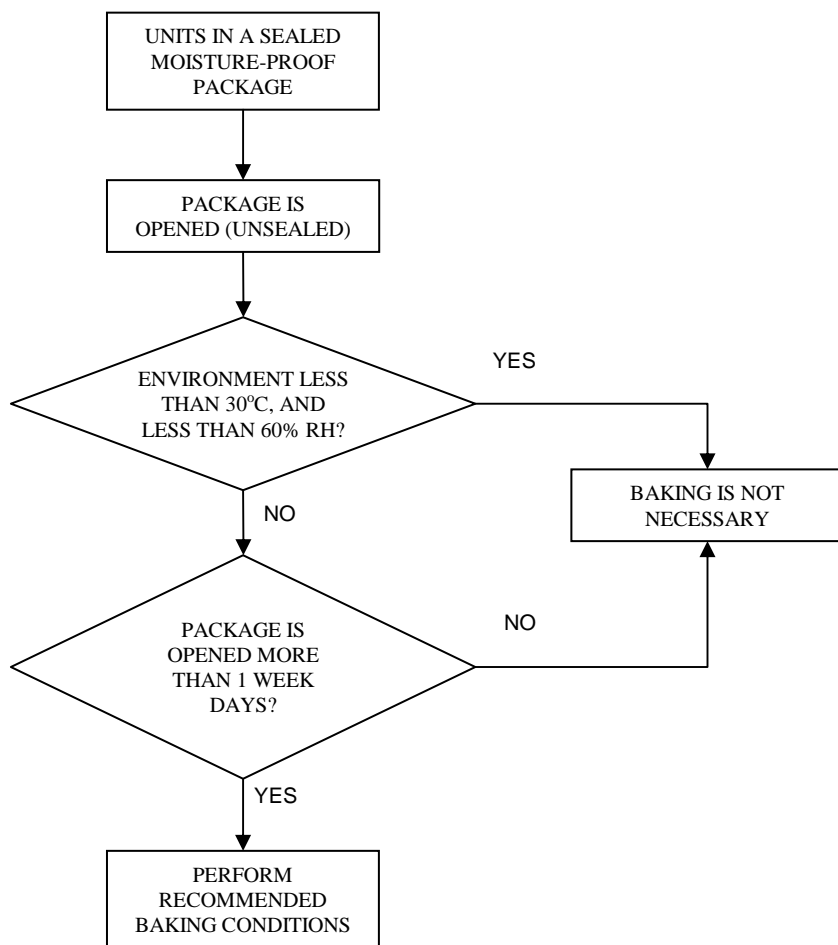

**Baking Conditions**

If the parts are not stored in dry conditions, they must be baked before reflow to prevent damage to the parts.

Package	Temperature	Time
In Reel	60°C	≥ 48hours
In Bulk	100°C	≥ 4hours
	125°C	≥ 2hours

**Baking should only be done once.**