

Excellent Integrated System Limited

Stocking Distributor

Click to view price, real time Inventory, Delivery & Lifecycle Information:

[Bel Fuse Inc.](#)
[RFI75-1](#)

For any questions, you can email us directly:

sales@integrated-circuit.com

DATA CONTAINED IN THIS DOCUMENT IS PROPRIETARY TO TROMPETER ELECTRONICS INC AND SHALL NOT BE DISCLOSED, COPIED OR USED FOR PROCUREMENT OR MANUFACTURE WITHOUT EXPRESS WRITTEN PERMISSION.

REV	DESCRIPTIONS	DATE	APPROVED
U	REVISED PER ECO # 16769	10/14/08	IC4moa

DASH NO	DESCRIPTION	DASH NO	ØA	ØB	C DIM	D DIM
-1	NO CHAIN	-D2	.630	.750	1.066	.450
-2	2.5 BRASS CHAIN	-D3	.505	.625	.941	.388
-3	2.5 NYLON CHAIN	-D4	.439	.562	.878	.355
-4	3.0 BRASS CHAIN	-D5	.380	.500	.816	.325
-5	3.0 NYLON CHAIN	-D6	.317	.437	.753	.295
-6	6.0 BRASS CHAIN	-D7	.281	.406	.722	.278
-7	6.0 NYLON CHAIN	-D8	.610	.750	1.066	.450
-8	4.0 BRASS CHAIN	-D9	.567	.687	1.003	.419
-9	4.0 NYLON CHAIN	-D10	.192	.312	.628	.231
-10	10.0 BRASS CHAIN	-DD8	.330	.450	.766	.300
-11	10.0 NYLON CHAIN					
-12	2.5 SST ROPE					
-13	3.0 SST ROPE					
-14	6.0 SST ROPE					
-15	4.0 SST ROPE					
-16	7.0 SST ROPE					
-17	4.5 SST ROPE					
-18	12.0 SST ROPE					
-19	18.0 SST ROPE					

DASH NO	ØA	ØB	C DIM	D DIM
-D2	.630	.750	1.066	.450
-D3	.505	.625	.941	.388
-D4	.439	.562	.878	.355
-D5	.380	.500	.816	.325
-D6	.317	.437	.753	.295
-D7	.281	.406	.722	.278
-D8	.610	.750	1.066	.450
-D9	.567	.687	1.003	.419
-D10	.192	.312	.628	.231
-DD8	.330	.450	.766	.300

KEYING LETTER	E DEGREES	F DEGREES	G DEGREES	COLOR BAND
NONE	120°	120°	120°	NONE
T	100°	150°	110°	RED
U	120°	130°	110°	ORANGE
V	115°	130°	115°	YELLOW
W	125°	110°	125°	GREEN
X	130°	100°	130°	BLUE
Y	110°	140°	110°	VIOLET
Z	100°	160°	100°	GRAY
S	135°	135°	90°	WHITE

MODEL NUMBER	
RF175	3-LUG
RF175FL	4-LUG

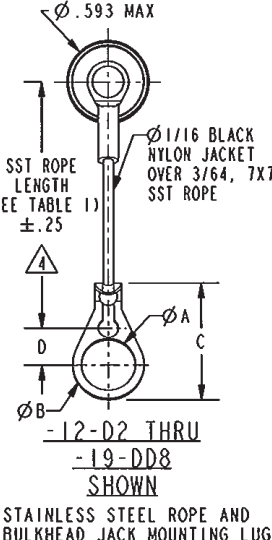
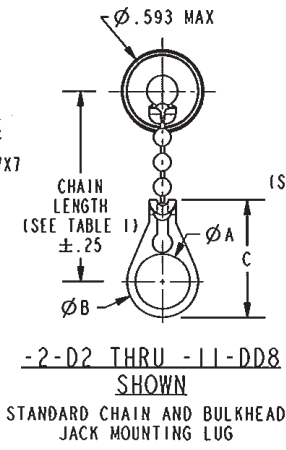
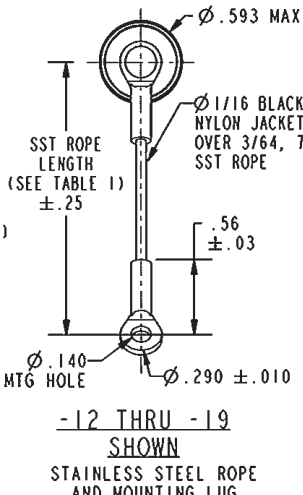
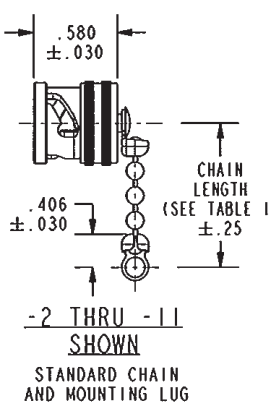
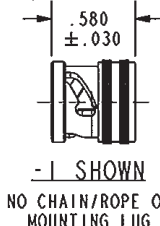
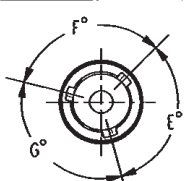

3. EXAMPLE OF COMPLETE MODEL NUMBER:

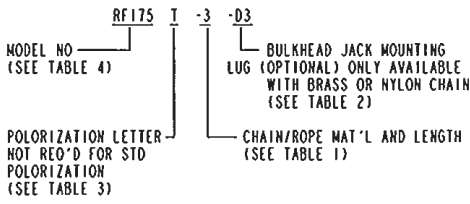

2. FINISH: TFS-1A (NICKEL)

1. 3 AND 4 LUG BNC/TRB DUST CAP WITH CHAIN/ROPE OR MOUNTING LUG OPTIONS

NOTES: UNLESS OTHERWISE SPECIFIED.

NOTE THAT LENGTH FOR SST ROPE WITH MOUNTING LUG OPTION IS NOT MEASURED TO CENTER OF BULKHEAD MOUNTING LUG

RED INDICATES ORIGINAL

INTERPRET DRAWING PER MIL-STD-100. DIMENSIONS ARE IN INCHES AND INCLUDE FINISH THICKNESS UNLESS OTHERWISE SPECIFIED.	TOL: UNLESS SPECIFIED. .XX ± .02 .XXX ± .010 ANGLE ± 1°
BY: J. CARPENTER 09-12-08	MATERIAL:
CHK: M.J. 10-17-08	FINISH:
DATE: 10-13-08	TITLE:
PROJ FILE NO: 305-0001	SIZE: A
NEXT ASSY:	CAGE CODE: 14949
	DRAWING NO: 305-0001
	SCALE: 2/1
	DATE: 10-4-67
	SHEET: 1C



RF175/RF175FL
T/U/V/W/X/Y/Z/S