

Excellent Integrated System Limited

Stocking Distributor

Click to view price, real time Inventory, Delivery & Lifecycle Information:

[Comair Rotron](#)
[19032525A](#)

For any questions, you can email us directly:

sales@integrated-circuit.com



Muffin XP - MS12B3 - 032525 - No
 (Family) (Model) (Part #) (In Stock)

Electrical Specifications

Operating Voltage:	12 Volts
Voltage Range:	6 - 14 Volts
Power Supply:	7.0 Watts
Line Current:	0.58 Amps
Locked Rotor Current:	1.45 Amps
Nominal Speed:	2900 RPM



Mechanical Specifications

Dimensions:	4.7 x 4.7 x 1.5 in
Weight	8.82 oz
Max Airflow @ 0 in H ₂ O	110.0 CFM
Max Pressure @ 0 CFM	0.252 in H ₂ O
Noise	49.5 dBA



Mechanical Drawing

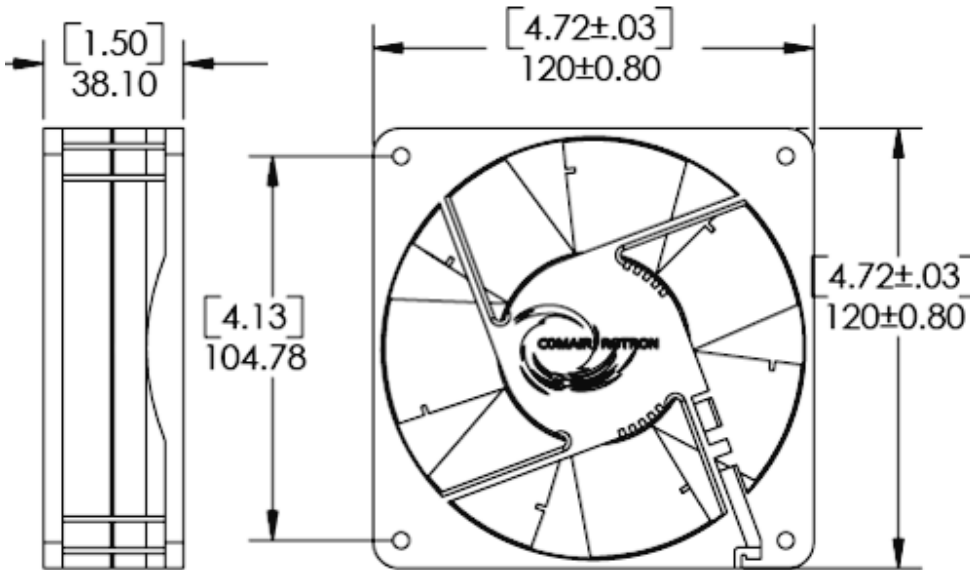

Comair Rotron, Inc.
 Phone: 619.651.2000
 sales@comairrotron.com

Comair Rotron Europe, Ltd.
 Phone: +44.1527.520525
 sales@comairrotron.com

Comair Rotron Fan Company Ltd.
 Phone: +86.21.52260581
 salesasia@comairrotron.com

Print Date: Friday, November 20, 2009 at 12:36:43 - DC Fan Datasheet - Web Version 1.0 Rev. B



Fan Performance Curve

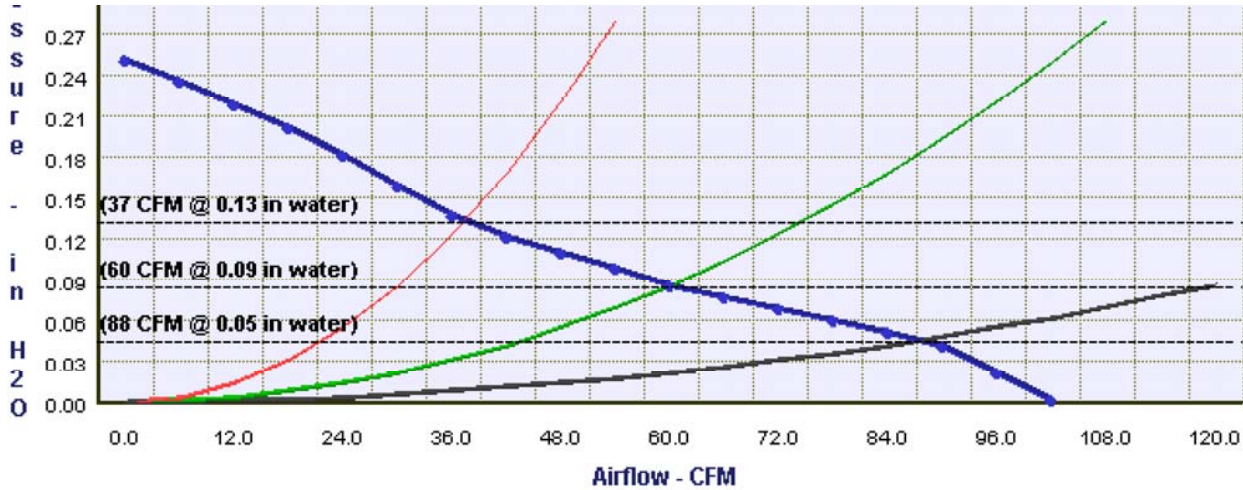

Fan Configuration Options

Muffin XP (Family) **MS12B3 / 032525** (Model) **No** (In Stock) **305 mm [12 inch] Leads** (Features)

Fan Speed: 2900 RPM Fan Bearings: Ball Bearings
 Fan Airflow Direction: Flow R (CCW Rotation) Fan Termination: Leads

Fan Monitoring Options: No Fan Monitoring Options Selected

Fan Speed Control Option: No ThermaPro-V Fan Speed Control Options Selected

Environmental Protection Options: No Enviroshield Options Selected

Comair Rotron, Inc.
 Phone: 619.651.2000
 sales@comairrotron.com

Comair Rotron Europe, Ltd.
 Phone: +44.1527.520525
 saleseurope@comairrotron.com

Comair Rotron Fan Company Ltd.
 Phone: +86.21.52260581
 salesasia@comairrotron.com

Print Date: Friday, November 20, 2009 at 12:36:43 - DC Fan Datasheet - Web Version 1.0 Rev. B



Accessories (Click on part number for detailed drawing.)

- 571064 Plug and Cord



- 550113 Mounting Clip

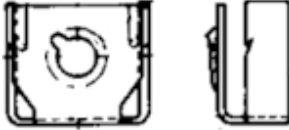

- 551590 Filter Assembly

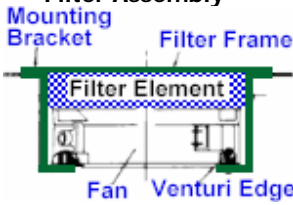

- 554148 Filter Guard Assembly

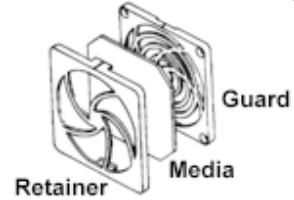

- 552934 Finger Guard



- 476042 Finger Guard

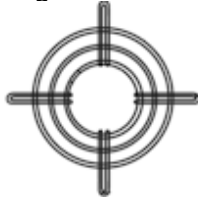

- 550481 Finger Guard

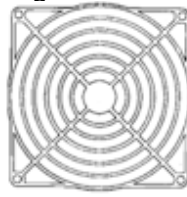

- 551147 Finger Guard

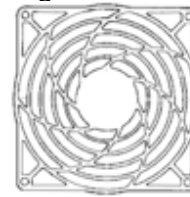

Comair Rotron, Inc.
Phone: 619.651.2000
sales@comairrotron.com

Comair Rotron Europe, Ltd.
Phone: +44.1527.520525
saleseurope@comairrotron.com

Comair Rotron Fan Company Ltd.
Phone: +86.21.52260581
salesasia@comairrotron.com

Print Date: Friday, November 20, 2009 at 12:36:43 - DC Fan Datasheet - Web Version 1.0 Rev. B