

Excellent Integrated System Limited

Stocking Distributor

Click to view price, real time Inventory, Delivery & Lifecycle Information:

[Molex Connector Corporation](#)
[0759001141](#)

For any questions, you can email us directly:

sales@integrated-circuit.com

CUSTOMER SHROUD DESIGN DETAILS

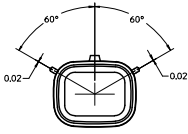

KEYING OPTION "A"
SUGGESTED COLOR: BLACK

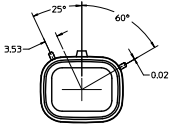

KEYING OPTION "B"
SUGGESTED COLOR: GREY

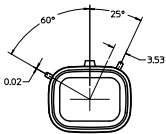

KEYING OPTION "C"
SUGGESTED COLOR: BROWN

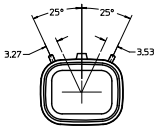

KEYING OPTION "D"
SUGGESTED COLOR: GREEN

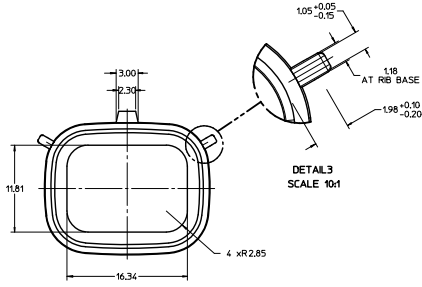

DETAIL 3
SCALE 10:1

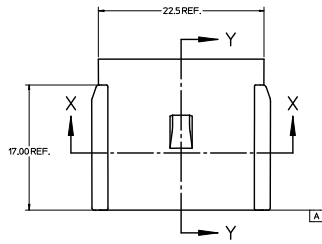

SECTION X-X
SCALE 4:1

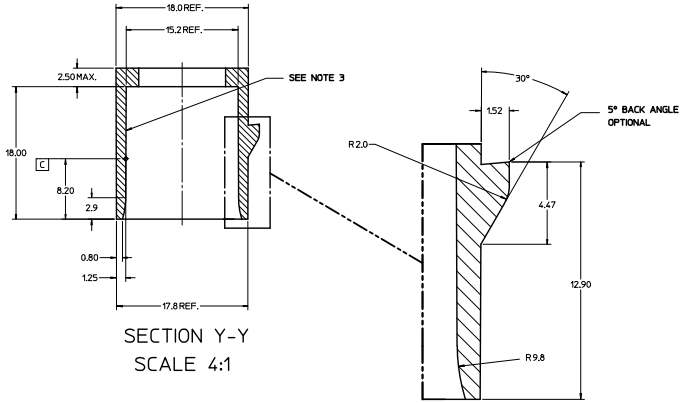
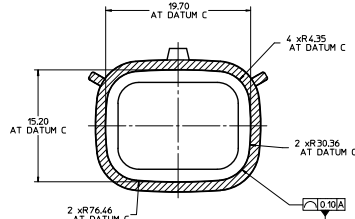

SECTION Y-Y
SCALE 4:1

DETAIL 2
SCALE 10:1

- NOTES:**
1. REFER TO MOLEX SALES DRAWING SD-75900-001 FOR THE R/A HEADER ASSEMBLY PRODUCT DETAILS AND RECOMMENDED PCB LAYOUT.
 2. KEYING OPTIONS A-D AND SUGGESTED COLORS COMPLY TO THE POLARIZATION STANDARDS ESTABLISHED FOR MATING WITH A MX150 FEMALE CONNECTOR.
 3. INTERIOR SHROUD SURFACE MUST BE FREE OF DEFECTS AND PARTING LINES ALL AROUND TO ENSURE PROPER SEALING OF THE MATING MX150 FEMALE CONNECTOR.
 4. A FULL SHROUD ON THE MATING CONNECTOR IS REQUIRED TO INSURE THE HEADER SHROUD POLARIZATION FEATURES (OPTIONS A-D) WILL FUNCTION PROPERLY. THE FULL SHROUD ALSO PREVENTS SCOPING DAMAGE TO THE HEADER CONTACTS.
 5. PERMISSIBLE DRAFT ANGLE 0.25/0.04/0.015 MAXIMUM.
 6. RADI ON ALL CORNERS SHOWN SHARP OR ALL UNSPECIFIED RADI 0.25 EXCEPT AS NOTED.
 7. DIMENSIONS SHOWN ABOUT A CENTERLINE ARE SYMMETRICAL ABOUT THAT CENTERLINE WITHIN HALF THE SPECIFIED TOLERANCE.

CHANGE CLASS EC INCL 07/2012-08/66 B CHNG: DR/ANWAR/GS/A 2011/09/16 APPR: LOMRELL 2011/09/16 DESG: 02	QUALITY SYMBOLS ▽=0 ▽=0	GENERAL TOLERANCES (UNLESS SPECIFIED) 4 PLACES ±---+--- 3 PLACES ±---+--- 2 PLACES ±0.10+--- 1 PLACE ±0.2+--- ANGULAR ±1/2°	DIMENSION STYLE MM ONLY DRAWN BY: DRUSLA 04/26/10 CHECKED BY: JCOMERC I 04/26/10 APPROVED BY: JCOMERC I 04/26/10	SCALE 2:1	DESIGN UNITS METRIC	THIRD ANGLE PROJECTION	
	DRAFT WHERE APPLICABLE MUST REMAIN WITHIN DIMENSIONS	PARTIAL NO. 75900-2040	DOCUMENT NO. AS-75900-204	TITLE APPLICATION SPEC 2X4 MX150 R/A HEADER SHROUD DETAILS	SHEET NO. 1 OF 2	MOLEX INCORPORATED	
	THIS DRAWING CONTAINS INFORMATION THAT IS PROPRIETARY TO MOLEX INCORPORATED AND SHOULD NOT BE USED WITHOUT WRITTEN PERMISSION						
	© 2011 MOLEX INCORPORATED						

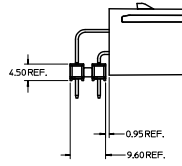
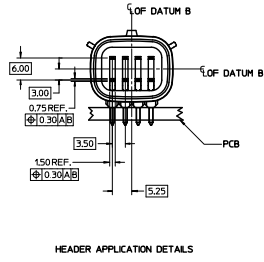
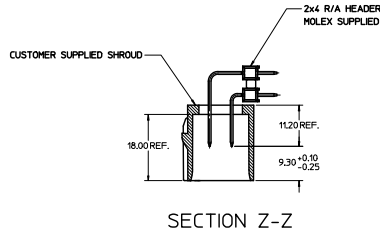
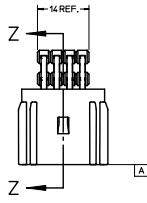

NOTES:
1. ADHERENCE TO THE HEADER APPLICATION DETAILS IS IMPERATIVE TO ENSURE PROPOER SHROUD SEALING AND CONTACT ALIGNMENT WHEN MATED WITH A MX150 FEMALE CONNECTOR.

ENTER DESCRIPTION EC NO. UEP202-0866 DRAWN BY DROS LA 2011/09/16 CHKC: JCOMERC I APPR: JCOMERC I 2011/09/16 REV: 01	QUALITY SYMBOLS	GENERAL TOLERANCES (UNLESS SPECIFIED)	DIMENSION STYLE	SCALE	DESIGN UNITS	THIRD ANGLE PROJECTION	
	4 PLACES ±0 3 PLACES ±0 2 PLACES ±0.10 1 PLACE ±0.2 ANGULAR ±1/2°	mm INCH +--- +--- +--- +--- +--- +--- +--- +--- +--- +---	DRAWN BY DROS LA CHECKED BY JCOMERC I APPROVED BY JCOMERC I DATE 04/26/07 DATE 04/26/07 DATE 04/26/07	MM ONLY	2:1	METRIC	THIRD ANGLE PROJECTION APPLICATION SPEC 2X4 MX150 R/A HEADER SHROUD DETAILS
	DRAFT WHERE APPLICABLE MUST REMAIN WITHIN DIMENSIONS	MATERIAL NO. 75900-2040 SIZE D THIS DRAWING CONTAINS INFORMATION THAT IS PROPRIETARY TO MOLEX INCORPORATED AND SHOULD NOT BE USED WITHOUT WRITTEN PERMISSION	MOLEX INCORPORATED	DOCUMENT NO. AS-75900-204	SHEET NO. 2 OF 2		

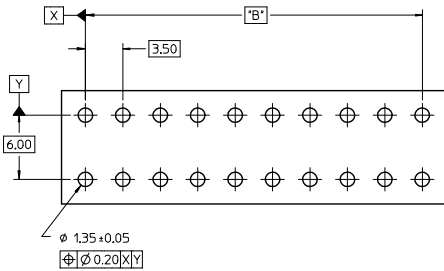
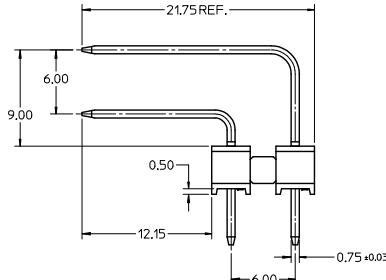
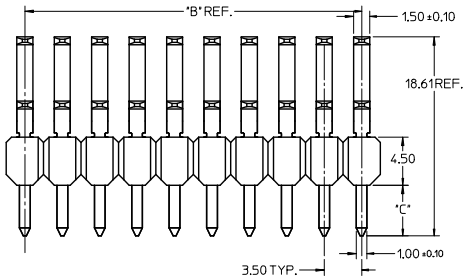
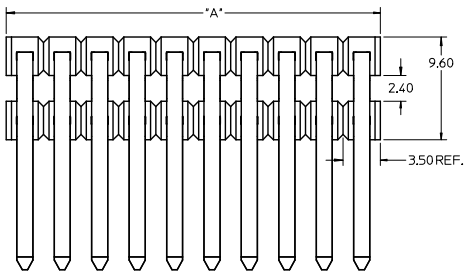

RECOMMENDED PCB LAYOUT

NOTES:

1. TERMINAL MAT'L: ALLOY C26000, CARTRIDGE BRASS
2. WAFER MAT'L: 30% GLASS FILLED LCP, 94V-0, COLOR BLACK.
3. TERMINAL PLATING:
 - OPTION 4 - 1.5 μ m MIN MATTE TIN OVERALL OVER 1.25 μ m NICKEL OVERALL
 - OPTION 1 - 2.5 μ m MIN MATTE TIN OVERALL OVER 1.25 μ m NICKEL OVERALL
 - OPTION 2 - 1.25 μ m NICKEL OVERALL 2.5 μ m MIN SELECT MATTE TIN PC TAIL AREA 0.05-0.25 μ m SELECT GOLD CONTACT AREA
 - OPTION 3 - 1.25 μ m NICKEL OVERALL 2.5 μ m MIN SELECT MATTE TIN PC TAIL AREA 0.75 μ m SELECT GOLD CONTACT AREA
4. HEADER ASSEMBLIES ARE TUBE PACKAGED PER PK-36518-351.

PKT	PLATING OPTION	MATERIAL NUMBER	*A* DIM	*B* DIM	*C* DIM	MATERIAL NUMBER	*A* DIM	*B* DIM	*C* DIM
2 x 2	1	75900-1121	7.0	3.50 REF		75900-1122	7.0	3.50 REF	
	2	75900-1221				75900-1222			
	3	75900-1321				75900-1322			
	4	75900-1421				75900-1422			
2 x 3	1	75900-1131	10.5	7.00		75900-1132	10.5	7.00	
	2	75900-1231				75900-1232			
	3	75900-1331				75900-1332			
	4	75900-1431				75900-1432			
2 x 4	1	75900-1141	14.0	10.50		75900-1142	14.0	10.50	
	2	75900-1241				75900-1242			
	3	75900-1341				75900-1342			
	4	75900-1441				75900-1442			
2 x 5	1	75900-1151	17.5	14.00	3.05	75900-1152	17.5	14.00	4.75
	2	75900-1251				75900-1252			
	3	75900-1351				75900-1352			
	4	75900-1451				75900-1452			
2 x 6	1	75900-1161	21.0	17.50		75900-1162	21.0	17.50	
	2	75900-1261				75900-1262			
	3	75900-1361				75900-1362			
	4	75900-1461				75900-1462			
2 x 8	1	75900-1181	28.0	24.50		75900-1182	28.0	24.50	
	2	75900-1281				75900-1282			
	3	75900-1381				75900-1382			
	4	75900-1481				75900-1482			
2 x 10	1	75900-1101	35.0	31.50		75900-1102	35.0	31.50	
	2	75900-1201				75900-1202			
	3	75900-1301				75900-1302			
	4	75900-1401				75900-1402			

PK SPEC UPDATED EC NO: 2016-0115 DRAWN: BR02 CHKD: APP: KPRASAD	2016/05/16 2016/06/03	QUALITY SYMBOLS ▽=0 ▽=0 ▽=0	GENERAL TOLERANCES (UNLESS SPECIFIED)		DIMENSION STYLE MM ONLY		SCALE 4:1	DESIGN UNITS METRIC	THIRD ANGLE PROJECTION	
			4 PLACES ±--- ±---	mm INCH	DRAWN BY TMCLELL	DATE 1/25/06	TITLE MX150 RIGHT ANGLE DUAL ROW UNSHROUDED HEADER ASSEMBLY			
			3 PLACES ±--- ±---		CHECKED BY	DATE	molex			
			2 PLACES ±0.13 ±---		TMCLELL	1/25/06				
1 PLACE ±0.25 ±---		APPROVED BY	DATE	MATERIAL NO. SEE CHART	DOCUMENT NO. SD-75900-001	SHEET NO. 1 OF 1				
0 PLACE ±		BANAKIS	1/25/06	DRAFT WHERE APPLICABLE MUST REMAIN WITHIN DIMENSIONS						