

Excellent Integrated System Limited

Stocking Distributor

Click to view price, real time Inventory, Delivery & Lifecycle Information:

[Molex Connector Corporation](#)
[0761452607](#)

For any questions, you can email us directly:

sales@integrated-circuit.com

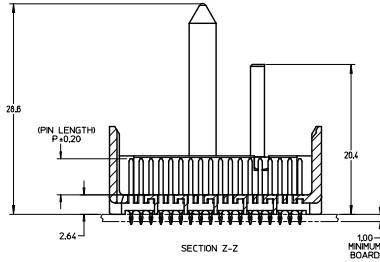
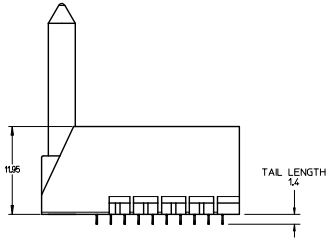
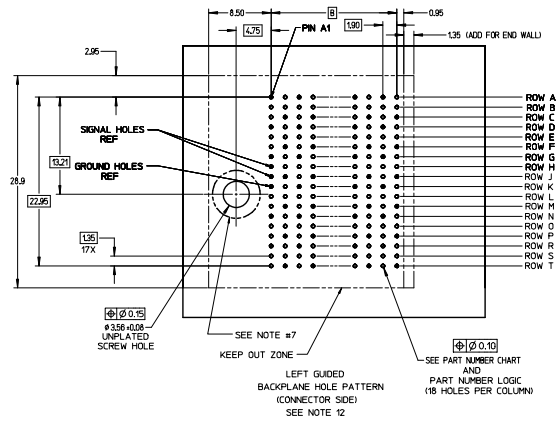
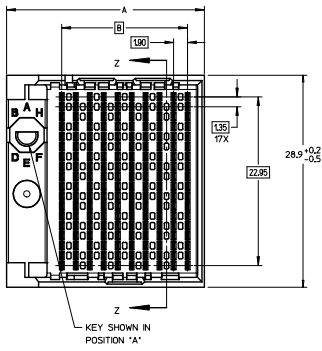

NOTES:

1. MATERIALS: HOUSING - LIQUID CRYSTAL POLYMER (LCP)
GLASS-FILLED, UL94V-0
- TERMINALS - HIGH PERFORMANCE COPPER ALLOY
2. FINISH: 5 MICRONCH MINIMUM GOLD FLASH OVER 20 MICRONCH MINIMUM Pd-Ni IN CONTACT AREA. SELECTIVE TIN ON PCB TAILS. NICKEL OVERALL.
3. REFER TO MOLEX PRODUCT SPECIFICATION PS-76060-999 FOR PERFORMANCE SPECIFICATIONS AND ADDITIONAL PCB INFORMATION.
4. THIS PART CONFORMS TO CLASS B REQUIREMENTS OF MOLEX COSMETIC SPEC PS-45499-002.
5. PACKAGE PER: PK-70873-760
6. SEE SHEETS 2 & 3 FOR PART NUMBERS AND BOARD RELATIONSHIPS.
7. FOR GROUNDED GUIDE PINS USE DIA: 3.56 +/- 0.08 (PTH) DIA. 3.66 (DRILL) AND DIA 6.5 (PAD).
8. MATES WITH IMPACT DC SERIES NO. 76150.
9. KEEP OUT ZONE FOR BP HOUSING LENGTH INCLUDES AN ADDITIONAL 10MM TO ACCOMMODATE FOR SPACE REQUIRED BY DC FRONT HOUSING.
10. REFER TO MOLEX PCB ROUTING GUIDE AS-76060-990 FOR ANTI-PAD AND ROUTING RECOMMENDATIONS.
11. CONNECTORS SUPPLIED WITH A 2-56 UNC-2A SCREW.
12. THESE DIMENSIONS REPRESENT THE AREA NEEDED TO ACCOMMODATE CONNECTOR INSERTION AND REPAIR ON THE PCB BOARD. THIS IS REFERRED TO AS THE "CONNECTOR KEEP OUT ZONE" AND DOES NOT REPRESENT THE ACTUAL PERIMETER OF THE CONNECTOR, WHEN LAYING OUT A PCB BOARD FOR CONNECTORS STACKED TOGETHER, USE A 1.9mm PROGRESSION.

Pd-Ni
PLATING

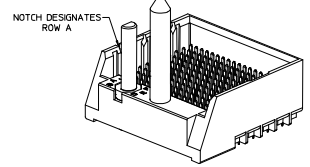

QUALITY SYMBOLS	GENERAL TOLERANCES (UNLESS SPECIFIED)		DIMENSION STYLE		SCALE	DESIGN UNITS	THIRD ANGLE PROJECTION
	mm	INCH	MM ONLY	METRIC			
▽=0	4 PLACES ±	---	DRAWN BY	DATE	4:1	METRIC	
▽=0	3 PLACES ±	---	SVANG01	2015/12/09			
▽=0	2 PLACES ±	0.13	CHECKED BY	DATE			
▽=0	1 PLACE ±	0.25	WOLFE	2015/12/09			
▽=0	0 PLACE ±	---	APPROVED BY	DATE			
			SMILLER	2015/12/17			
			ANGULAR ±1/2°				
			DRAFT WHERE APPLICABLE MUST REMAIN WITHIN DIMENSIONS				
			SEE TABLE				
			THIS DRAWING CONTAINS INFORMATION THAT IS PROPRIETARY TO MOLEX INCORPORATED AND SHOULD NOT BE USED WITHOUT WRITTEN PERMISSION				

PART NUMBER LOGIC

173432-***

MODULE TYPE

- 3 = GUIDE LEFT, TIN
- 7 = GUIDE LEFT END WALL, TIN

OF COLUMNS

- 1 = 10 COL
- 6 = 16 COL
- 7 = 14 COL

PIN LENGTH (P)

- 3 = 4.50 (SHORT COMPLIANT, 0.46±0.05 PTH)
- 4 = 4.90 (SHORT COMPLIANT, 0.46±0.05 PTH)
- 5 = 5.50 (SHORT COMPLIANT, 0.46±0.05 PTH)
- 6 = 4.50 (MICRO COMPLIANT, 0.39±0.05 PTH)
- 7 = 4.90 (MICRO COMPLIANT, 0.39±0.05 PTH)
- 8 = 5.50 (MICRO COMPLIANT, 0.39±0.05 PTH)

KEY ORIENTATION

- 0 = NO KEY
- 1 = A
- 2 = B
- 3 = C
- 4 = D
- 5 = E
- 6 = F
- 7 = G
- 8 = H

PART NUMBER TABLE

MATERIAL NUMBER	# OF COLUMNS	# OF DIFF PAIR	DIM 'A'	DIM 'B'	
173432- \times 1**	10	60	26.9	17.10	GUIDE LEFT END WALL OPTION
173432- \times 7**	14	84	34.5	24.70	
173432- \times 6**	16	96	38.3	28.50	

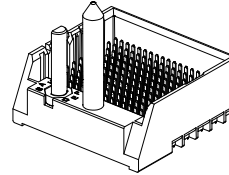

GUIDE LEFT
END WALL
OPTION

MATERIAL NUMBER	# OF COLUMNS	# OF DIFF PAIR	DIM 'A'	DIM 'B'	
173432- \times 1**	10	60	25.5	17.10	GUIDE LEFT OPEN WALL OPTION
173432- \times 7**	14	84	33.1	24.70	
173432- \times 6**	16	96	36.9	28.50	

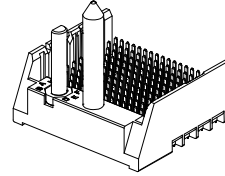

GUIDE LEFT
OPEN WALL
OPTION

SEE SHEET 1 EC NO: UCP2016-2332 DRAWN BY: SVANG01 CHKD BY: MWOLFE APPR: SMILLER DATE: 2015/12/09 DATE: 2015/12/09 DATE: 2015/12/17	QUALITY SYMBOLS ∇=0 ∇=0 ∇=0	GENERAL TOLERANCES (UNLESS SPECIFIED)		DIMENSION STYLE		SCALE	DESIGN UNITS	THIRD ANGLE PROJECTION	
				MM ONLY		2:1	METRIC		
		4 PLACES ± --- ± ---		DRAWN BY: SVANG01		DATE: 2015/12/09		TITLE IMPACT 6 PAIR HEADER LEFT GUIDED PDNI ASSEMBLY SALES DRAWING molex	
		3 PLACES ± --- ± ---		CHECKED BY: MWOLFE		DATE: 2015/12/09			
2 PLACES ± 0.13 ± ---		APPROVED BY: SMILLER		DATE: 2015/12/17					
1 PLACE ± 0.25 ± ---		MATERIAL NO. RSD-173432-002		DOCUMENT NO. RSD-173432-002					
0 PLACE ± ±		ANGULAR ± 1/2°		DRAFT WHERE APPLICABLE MUST REMAIN WITHIN DIMENSIONS		SHEET NO. 2 OF 3			

IMPACT 6 PAIR
BOARD RELATIONSHIPS

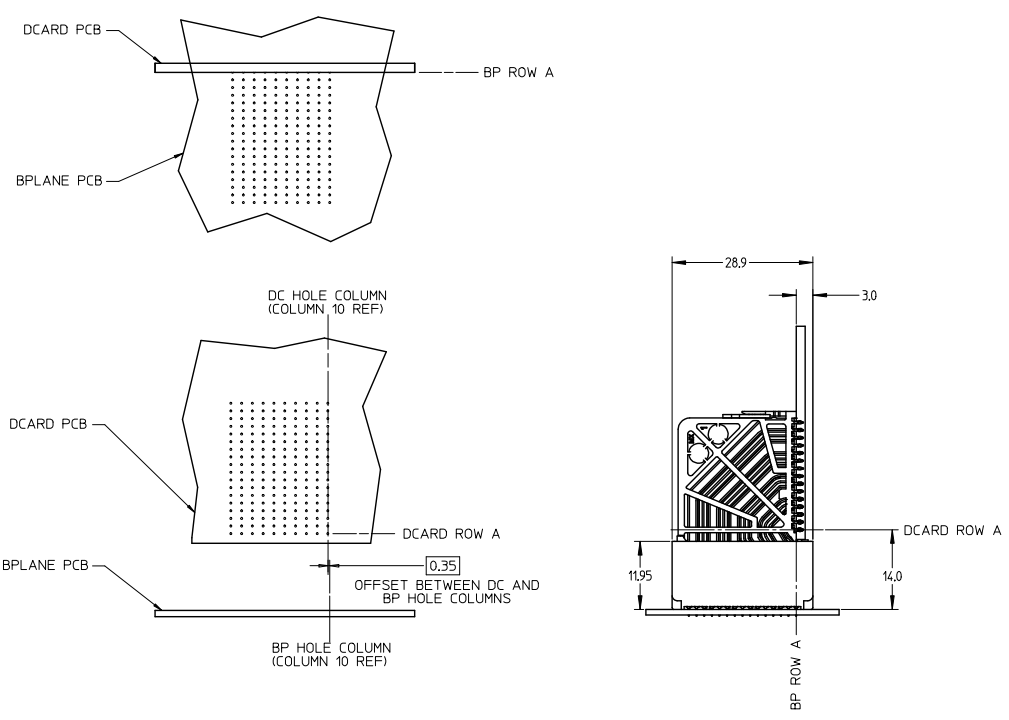

SEE SHEET 1 EC NO: UCP2016-2332 DRAWN BY: SVANG01 2015/12/09 CHECKED BY: MWOLFE 2015/12/09 APPROVED BY: SMILLER 2015/12/17	QUALITY SYMBOLS ∇=0 ∇=0 ∇=0	GENERAL TOLERANCES (UNLESS SPECIFIED)		DIMENSION STYLE MM ONLY		SCALE 2:1	DESIGN UNITS METRIC	THIRD ANGLE PROJECTION	
			mm	INCH	DRAWN BY SVANG01	DATE 2015/12/09	TITLE IMPACT 6 PAIR HEADER LEFT GUIDED PDNI ASSEMBLY SALES DRAWING molex MATERIAL NO. SEE TABLE DOCUMENT NO. RSD-173432-002 SHEET NO. 3 OF 3		
		4 PLACES ±	---	---	CHECKED BY MWOLFE	DATE 2015/12/09			
		3 PLACES ±	---	---	APPROVED BY SMILLER	DATE 2015/12/17			
2 PLACES ±	0.13	---							
		1 PLACE ±	0.25	---					
		0 PLACE ±							
		ANGULAR ±1/2°		MATERIAL NO.		DOCUMENT NO.		SHEET NO.	
		DRAFT WHERE APPLICABLE MUST REMAIN WITHIN DIMENSIONS		SEE TABLE		RSD-173432-002		3 OF 3	
				SIZE C		THIS DRAWING CONTAINS INFORMATION THAT IS PROPRIETARY TO MOLEX INCORPORATED AND SHOULD NOT BE USED WITHOUT WRITTEN PERMISSION			

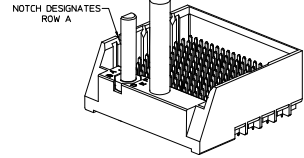
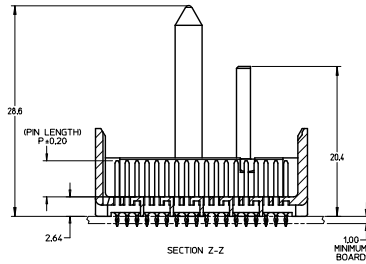
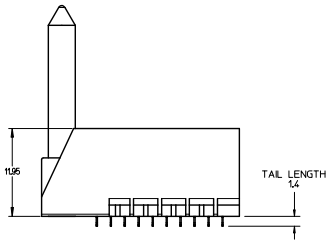
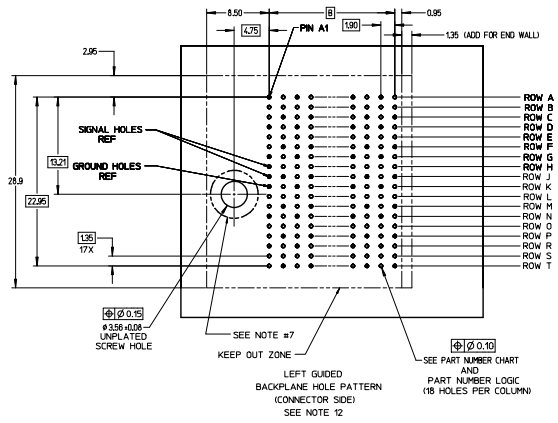
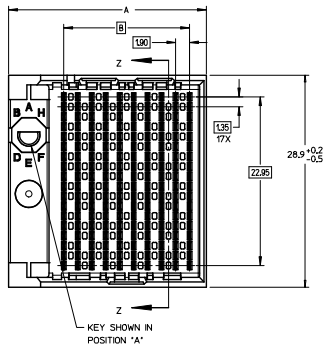

- NOTES:
1. MATERIALS: HOUSING - LIQUID CRYSTAL POLYMER (LCP)
GLASS-FILLED, UL94V-0
TERMINALS - HIGH PERFORMANCE COPPER ALLOY
SELECTIVE TIN ON PCB TAILS.
NICKEL OVERALL.
 2. REFER TO MOLEX PRODUCT SPECIFICATION PS-76060-999 FOR PERFORMANCE SPECIFICATIONS AND ADDITIONAL PCB INFORMATION.
 3. THIS PART CONFORMS TO CLASS B REQUIREMENTS OF MOLEX COSMETIC SPEC PS-45499-002.
 4. PACKAGE PERL: PK-70873-760.
 5. SEE SHEETS 2 & 3 FOR PART NUMBERS AND BOARD RELATIONSHIPS.
 6. FOR GROUNDED GUIDE PINS USE DIA. 3.56 +/- 0.08 (PTH) DIA. 3.66 (DRILL) AND DIA. 6.5 (PAD).
 7. MATES WITH IMPACT DC SERIES NO. 76150.
 8. KEEP OUT ZONE FOR BP HOUSING LENGTH INCLUDES AN ADDITIONAL 1.0MM TO ACCOMMODATE FOR SPACE REQUIRED BY DC FRONT HOUSING.
 9. REFER TO MOLEX PCB ROUTING GUIDE AS-76060-990 FOR ANTI PAD AND ROUTING RECOMMENDATIONS.
 10. CONNECTORS SUPPLIED WITH A 2-56 UNC-2A SCREW.
 11. THESE DIMENSIONS REPRESENT THE AREA NEEDED TO ACCOMMODATE CONNECTOR INSERTION AND REPAIR ON THE PCB BOARD. THIS IS REFERRED TO AS THE 'CONNECTOR KEEP OUT ZONE' AND DOES NOT REPRESENT THE ACTUAL PERIMETER OF THE CONNECTOR. WHEN LAYING OUT A PCB BOARD FOR CONNECTORS STACKED TOGETHER, USE A 1.5mm PROGRESSION.

REVISED (MINOR) ECN NO. UEP2014-0887 DRAWN: JB INGRAM CHECKED: JLAURX APPR: JLAURX DATE: 2010/07/12	QUALITY SYMBOLS	GENERAL TOLERANCES (UNLESS SPECIFIED)	DIMENSION STYLE MM ONLY	SCALE 4:1	DESIGN UNITS METRIC	THIRD ANGLE PROJECTION
	4 PLACES ± 0.13 3 PLACES ± 0.25 2 PLACES ± 0.50 1 PLACE ± 1.00 0 PLACE ± 1.50	DRAWN BY: MSANDBERG CHECKED BY: JLAURX APPROVED BY: JLAURX DATE: 2007/12/26 DATE: 2007/12/26 DATE: 2010/02/22	TITLE IMPACT 6 PAIR HEADER LEFT GUIDED ASSEMBLY SALES DRAWING	MATERIAL NO. SEE TABLE	DOCUMENT NO. SD-76145-002	SHEET NO. 1 OF 3

PART NUMBER LOGIC

76145-***

MODULE TYPE

- 3 = GUIDE LEFT, TIN
- 7 = GUIDE LEFT END WALL, TIN

OF COLUMNS

- 1 = 10 COL
- 6 = 16 COL
- 7 = 14 COL

PIN LENGTH (P)

- 3 = 4.50 (SHORT COMPLIANT, 0.46±0.05 PTH)
- 4 = 4.90 (SHORT COMPLIANT, 0.46±0.05 PTH)
- 5 = 5.50 (SHORT COMPLIANT, 0.46±0.05 PTH)
- 6 = 4.50 (MICRO COMPLIANT, 0.39±0.05 PTH)
- 7 = 4.90 (MICRO COMPLIANT, 0.39±0.05 PTH)
- 8 = 5.50 (MICRO COMPLIANT, 0.39±0.05 PTH)

KEY ORIENTATION

- 0 = NO KEY
- 1 = A
- 2 = B
- 3 = C
- 4 = D
- 5 = E
- 6 = F
- 7 = G
- 8 = H

PART NUMBER TABLE

MATERIAL NUMBER	# OF COLUMNS	# OF DIFF PAIR	DIM 'A'	DIM 'B'	GUIDE LEFT END WALL OPTION
76145-1**	10	60	26.9	17.10	
76145-7**	14	84	34.5	24.70	
76145-6**	16	96	38.3	28.50	

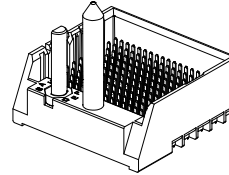

GUIDE LEFT
END WALL
OPTION

MATERIAL NUMBER	# OF COLUMNS	# OF DIFF PAIR	DIM 'A'	DIM 'B'	GUIDE LEFT OPEN WALL OPTION
76145-1**	10	60	25.5	17.10	
76145-7**	14	84	33.1	24.70	
76145-6**	16	96	36.9	28.50	

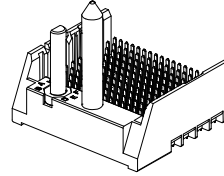

GUIDE LEFT
OPEN WALL
OPTION

SEE SHEET 1 EC NO: UCP2014-0887 DRAWN BY: INDIAN 2013/08/25 CHKD: LAURX 2013/08/25 APPR: LAURX 2013/09/25	QUALITY SYMBOLS ∇=0 ∇=0 ∇=0	GENERAL TOLERANCES (UNLESS SPECIFIED)		DIMENSION STYLE MM ONLY		SCALE 2:1	DESIGN UNITS METRIC	THIRD ANGLE PROJECTION		
		4 PLACES ± --- ± ---	3 PLACES ± --- ± ---	2 PLACES ± 0.13 ± ---	1 PLACE ± 0.25 ± ---	0 PLACE ± ±	DRAWN BY MSANDBERG	DATE 2007/12/26	TITLE IMPACT 6 PAIR HEADER LEFT GUIDED ASSEMBLY SALES DRAWING	
		ANGULAR ±1/2°		DRAFT WHERE APPLICABLE MUST REMAIN WITHIN DIMENSIONS		MATERIAL NO. SEE TABLE		DOCUMENT NO. SD-76145-002		SHEET NO. 2 OF 3
		THIS DRAWING CONTAINS INFORMATION THAT IS PROPRIETARY TO MOLEX INCORPORATED AND SHOULD NOT BE USED WITHOUT WRITTEN PERMISSION								

IMPACT 6 PAIR
BOARD RELATIONSHIPS

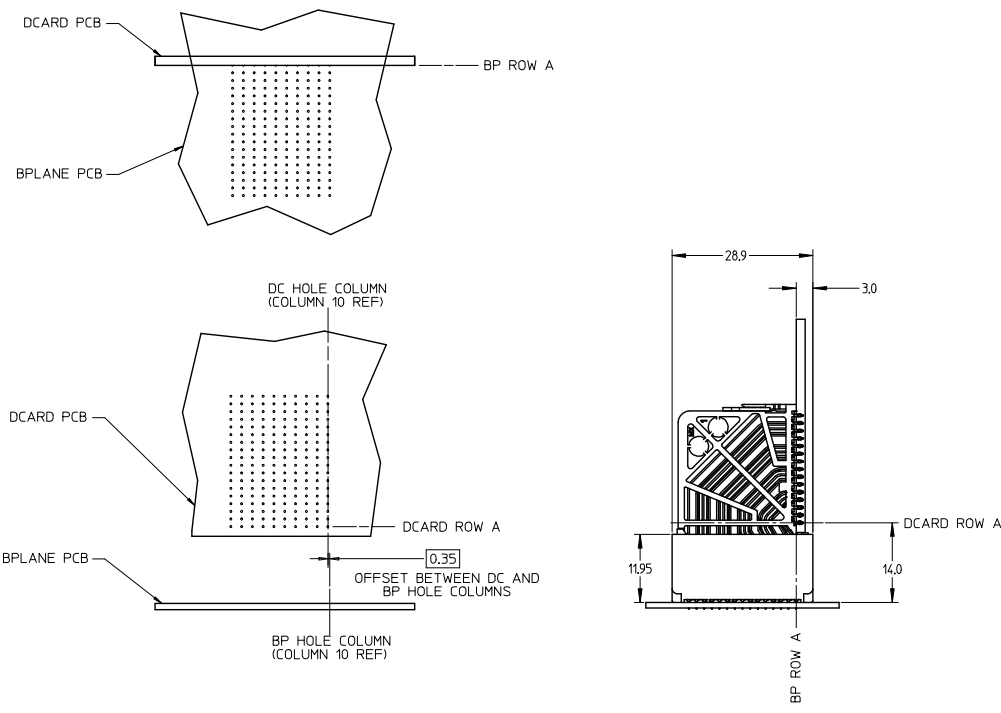

SEE SHEET 1 IEC NO: UCPC2014-0887 DRAWN: BINGHAM 2013/08/29 CHKD: LAURX 2013/08/29 APPR: LAURX 2013/09/23	QUALITY SYMBOLS ∇=0 ∇=0 ∇=0	GENERAL TOLERANCES (UNLESS SPECIFIED)		DIMENSION STYLE MM ONLY		SCALE 2:1	DESIGN UNITS METRIC	THIRD ANGLE PROJECTION
		4 PLACES ± --- ± --- 3 PLACES ± --- ± --- 2 PLACES ± 0.13 ± --- 1 PLACE ± 0.25 ± --- 0 PLACE ± ±	mm INCH --- --- --- --- --- --- --- --- --- ---	DRAWN BY MSANDBERG	DATE 2007/12/26	TITLE IMPACT 6 PAIR HEADER LEFT GUIDED ASSEMBLY SALES DRAWING		molex
REV G1	DESCRIPTION	ANGULAR ±1/2° DRAFT WHERE APPLICABLE MUST REMAIN WITHIN DIMENSIONS		MATERIAL NO. SEE TABLE		DOCUMENT NO. SD-76145-002		THIS DRAWING CONTAINS INFORMATION THAT IS PROPRIETARY TO MOLEX INCORPORATED AND SHOULD NOT BE USED WITHOUT WRITTEN PERMISSION