

## Excellent Integrated System Limited

Stocking Distributor

Click to view price, real time Inventory, Delivery & Lifecycle Information:

[Molex Connector Corporation](#)

[0761456106](#)

For any questions, you can email us directly:

[sales@integrated-circuit.com](mailto:sales@integrated-circuit.com)

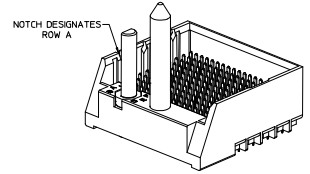
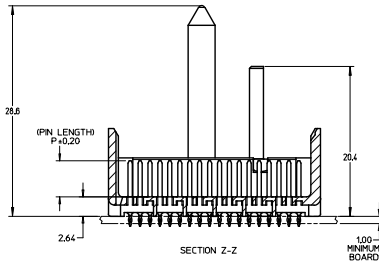
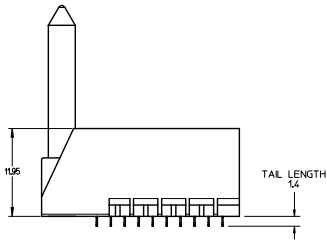
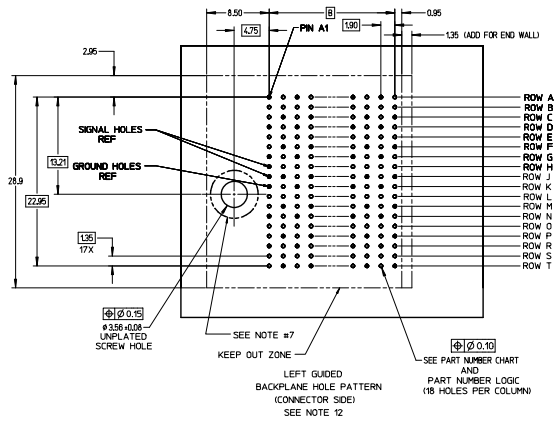
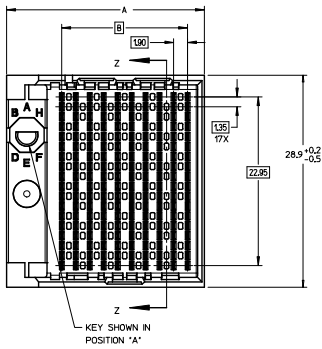

Pd-Ni  
PLATING

NOTES:

1. MATERIALS: HOUSING - LIQUID CRYSTAL POLYMER (LCP)  
GLASS-FILLED, UL94V-0
- TERMINALS - HIGH PERFORMANCE COPPER ALLOY
2. FINISH: 5 MICRONCH MINIMUM GOLD FLASH OVER 20 MICRONCH MINIMUM Pd-Ni IN CONTACT AREA. SELECTIVE TIN ON PCB TAILS. NICKEL OVERALL.
3. REFER TO MOLEX PRODUCT SPECIFICATION PS-76060-999 FOR PERFORMANCE SPECIFICATIONS AND ADDITIONAL PCB INFORMATION.
4. THIS PART CONFORMS TO CLASS B REQUIREMENTS OF MOLEX COSMETIC SPEC PS-45499-002.
5. PACKAGE PER: PK-70873-760
6. SEE SHEETS 2 & 3 FOR PART NUMBERS AND BOARD RELATIONSHIPS.
7. FOR GROUNDED GUIDE PINS USE DIA: 3.56 +/- 0.08 (PTH) DIA. 3.66 (DRILL) AND DIA 6.5 (PAD).
8. MATES WITH IMPACT DC SERIES NO. 76150.
9. KEEP OUT ZONE FOR BP HOUSING LENGTH INCLUDES AN ADDITIONAL 10MM TO ACCOMMODATE FOR SPACE REQUIRED BY DC FRONT HOUSING.
10. REFER TO MOLEX PCB ROUTING GUIDE AS-76060-990 FOR ANTI PAD AND ROUTING RECOMMENDATIONS.
11. CONNECTORS SUPPLIED WITH A 2-56 UNC-2A SCREW.
12. THESE DIMENSIONS REPRESENT THE AREA NEEDED TO ACCOMMODATE CONNECTOR INSERTION AND REPAIR ON THE PCB BOARD. THIS IS REFERRED TO AS THE "CONNECTOR KEEP OUT ZONE" AND DOES NOT REPRESENT THE ACTUAL PERIMETER OF THE CONNECTOR, WHEN LAYING OUT A PCB BOARD FOR CONNECTORS STACKED TOGETHER, USE A 1.9mm PROGRESSION.

QUALITY SYMBOLS	GENERAL TOLERANCES (UNLESS SPECIFIED)		DIMENSION STYLE		SCALE	DESIGN UNITS	THIRD ANGLE PROJECTION
	mm	INCH	MM ONLY	DATE	4:1	METRIC	☉
$\nabla=0$	4 PLACES ±	---	DRAWN BY	DATE	TITLE		
$\nabla=0$	3 PLACES ±	---	SVANG01	2015/12/09	IMPACT 6 PAIR HEADER		
$\nabla=0$	2 PLACES ±	0.13	CHECKED BY	DATE	LEFT GUIDED PDNI		
$\nabla=0$	1 PLACE ±	0.25	WOLFE	2015/12/09	ASSEMBLY SALES DRAWING		
$\nabla=0$	0 PLACE ±	±	APPROVED BY	DATE	<b>molex</b>		
			SMILLER	2015/12/17			
	ANGULAR ±1/2°		MATERIAL NO.		SHEET NO.		
	DRAFT WHERE APPLICABLE MUST REMAIN WITHIN DIMENSIONS		SEE TABLE		1 OF 3		
	SIZE D THIS DRAWING CONTAINS INFORMATION THAT IS PROPRIETARY TO MOLEX INCORPORATED AND SHOULD NOT BE USED WITHOUT WRITTEN PERMISSION						

PART NUMBER LOGIC

173432-\*\*\*

MODULE TYPE

- 3 = GUIDE LEFT, TIN
- 7 = GUIDE LEFT END WALL, TIN

# OF COLUMNS

- 1 = 10 COL
- 6 = 16 COL
- 7 = 14 COL

PIN LENGTH (P)

- 3 = 4.50 (SHORT COMPLIANT, 0.46±0.05 PTH)
- 4 = 4.90 (SHORT COMPLIANT, 0.46±0.05 PTH)
- 5 = 5.50 (SHORT COMPLIANT, 0.46±0.05 PTH)
- 6 = 4.50 (MICRO COMPLIANT, 0.39±0.05 PTH)
- 7 = 4.90 (MICRO COMPLIANT, 0.39±0.05 PTH)
- 8 = 5.50 (MICRO COMPLIANT, 0.39±0.05 PTH)

KEY ORIENTATION

- 0 = NO KEY
- 1 = A
- 2 = B
- 3 = C
- 4 = D
- 5 = E
- 6 = F
- 7 = G
- 8 = H

PART NUMBER TABLE

MATERIAL NUMBER	# OF COLUMNS	# OF DIFF PAIR	DIM 'A'	DIM 'B'	
173432- <b>*1**</b>	10	60	26.9	17.10	GUIDE LEFT END WALL OPTION
173432- <b>*7**</b>	14	84	34.5	24.70	
173432- <b>*6**</b>	16	96	38.3	28.50	

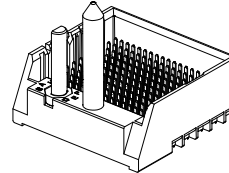

GUIDE LEFT  
END WALL  
OPTION

MATERIAL NUMBER	# OF COLUMNS	# OF DIFF PAIR	DIM 'A'	DIM 'B'	
173432- <b>*1**</b>	10	60	25.5	17.10	GUIDE LEFT OPEN WALL OPTION
173432- <b>*7**</b>	14	84	33.1	24.70	
173432- <b>*6**</b>	16	96	36.9	28.50	

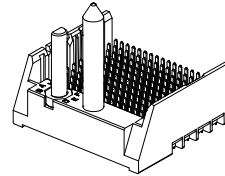

GUIDE LEFT  
OPEN WALL  
OPTION

SEE SHEET 1 EC NO: UCP2016-2332 DRAWN BY: SVANG01 CHKD BY: MWOLFE APPR: SMILLER DATE: 2015/12/09 DATE: 2015/12/09 DATE: 2015/12/17	QUALITY SYMBOLS ∇=0 ∇=0 ∇=0	GENERAL TOLERANCES (UNLESS SPECIFIED)		DIMENSION STYLE		SCALE	DESIGN UNITS	THIRD ANGLE PROJECTION	
				MM ONLY		2:1	METRIC		
		4 PLACES ± --- ± ---		DRAWN BY: SVANG01		DATE: 2015/12/09		TITLE IMPACT 6 PAIR HEADER LEFT GUIDED PDNI ASSEMBLY SALES DRAWING  <b>molex</b> MATERIAL NO. RSD-173432-002 DOCUMENT NO. SHEET NO. 2 OF 3	
		3 PLACES ± --- ± ---		CHECKED BY: MWOLFE		DATE: 2015/12/09			
2 PLACES ± 0.13 ± ---		APPROVED BY: SMILLER		DATE: 2015/12/17					
1 PLACE ± 0.25 ± ---									
0 PLACE ± ±									
		ANGULAR ± 1/2°		MATERIAL NO.		DOCUMENT NO.		SHEET NO.	
		DRAFT WHERE APPLICABLE MUST REMAIN WITHIN DIMENSIONS		SEE TABLE		RSD-173432-002		2 OF 3	
				SIZE C		THIS DRAWING CONTAINS INFORMATION THAT IS PROPRIETARY TO MOLEX INCORPORATED AND SHOULD NOT BE USED WITHOUT WRITTEN PERMISSION			

IMPACT 6 PAIR  
BOARD RELATIONSHIPS

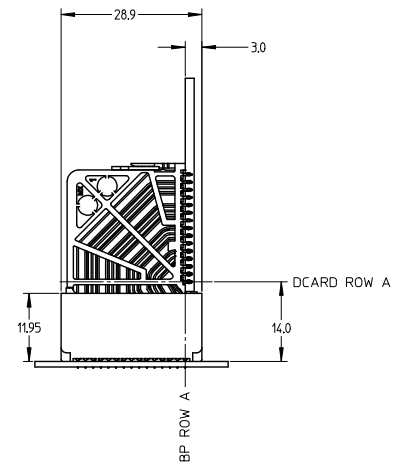
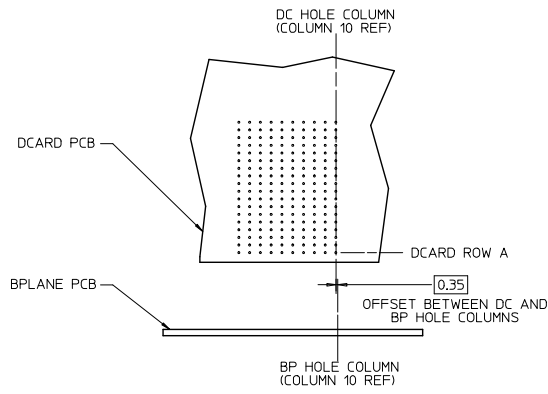
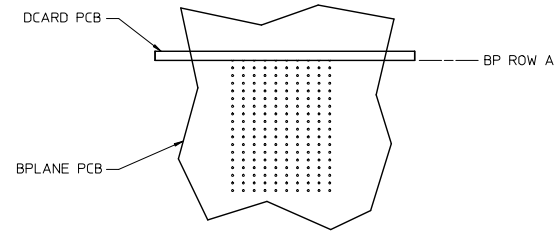

SEE SHEET 1 EC NO: UCP2016-2332 DRAWN BY: SVANG01 2015/12/09 CHECKED BY: MWOLFE 2015/12/09 APPROVED BY: SMILLER 2015/12/17	QUALITY SYMBOLS ∇=0 ∇=0 ∇=0	GENERAL TOLERANCES (UNLESS SPECIFIED)		DIMENSION STYLE MM ONLY		SCALE 2:1	DESIGN UNITS METRIC	THIRD ANGLE PROJECTION	
			mm	INCH	DRAWN BY SVANG01	DATE 2015/12/09	TITLE IMPACT 6 PAIR HEADER LEFT GUIDED PDNI ASSEMBLY SALES DRAWING <b>molex</b> DOCUMENT NO. RSD-173432-002 SHEET NO. 3 OF 3		
		4 PLACES ±	---	---	CHECKED BY MWOLFE	DATE 2015/12/09			
		3 PLACES ±	---	---	APPROVED BY SMILLER	DATE 2015/12/17			
2 PLACES ±	0.13	---							
		1 PLACE ±	0.25	---					
		0 PLACE ±							
		ANGULAR ±1/2°		MATERIAL NO.					
		DRAFT WHERE APPLICABLE MUST REMAIN WITHIN DIMENSIONS		SEE TABLE					
				SIZE C		THIS DRAWING CONTAINS INFORMATION THAT IS PROPRIETARY TO MOLEX INCORPORATED AND SHOULD NOT BE USED WITHOUT WRITTEN PERMISSION			

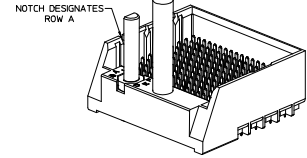
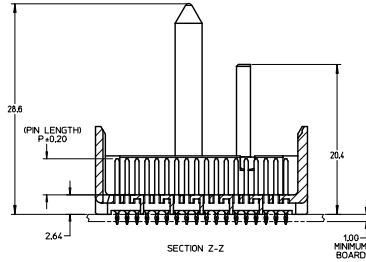
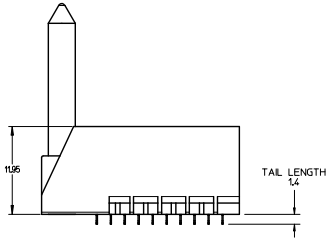
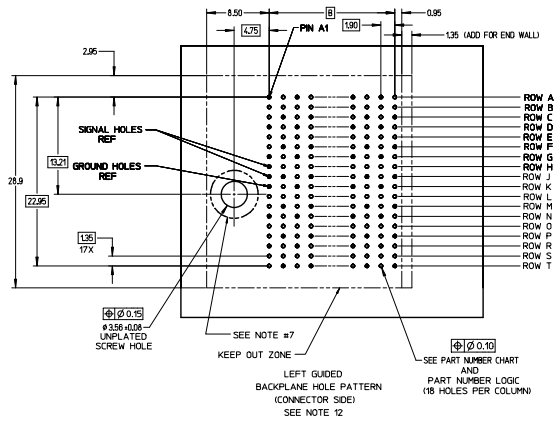
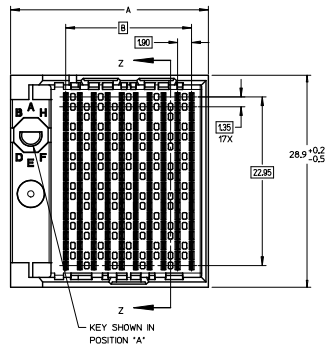

- NOTES:
1. MATERIALS: HOUSING - LIQUID CRYSTAL POLYMER (LCP)  
GLASS-FILLED, UL94V-0  
TERMINALS - HIGH PERFORMANCE COPPER ALLOY  
SELECTIVE TIN ON PCB TAILS.  
NICKEL OVERALL.
  2. REFER TO MOLEX PRODUCT SPECIFICATION PS-76060-999  
FOR PERFORMANCE SPECIFICATIONS AND ADDITIONAL PCB INFORMATION.
  3. THIS PART CONFORMS TO CLASS B REQUIREMENTS OF  
MOLEX COSMETIC SPEC PS-45499-002.
  4. PACKAGE PERL: PK-70873-760
  5. SEE SHEETS 2 & 3 FOR PART NUMBERS AND BOARD RELATIONSHIPS.
  6. FOR GROUNDED GUIDE PINS USE DIA. 3.56 +/- 0.08 (PTH)  
DIA. 3.66 (DRILL) AND DIA. 6.5 (PAD).
  7. MATES WITH IMPACT DC SERIES NO. 76150.
  8. KEEP OUT ZONE FOR BP HOUSING LENGTH INCLUDES AN ADDITIONAL 1.0MM  
TO ACCOMMODATE FOR SPACE REQUIRED BY DC FRONT HOUSING.
  9. REFER TO MOLEX PCB ROUTING GUIDE AS-76060-990 FOR ANTI PAD AND ROUTING RECOMMENDATIONS.
  10. CONNECTORS SUPPLIED WITH A 2-56 UNC-2A SCREW.
  11. THESE DIMENSIONS REPRESENT THE AREA NEEDED TO ACCOMMODATE CONNECTOR INSERTION AND  
REPAIR ON THE PCB BOARD. THIS IS REFERRED TO AS THE 'CONNECTOR KEEP OUT ZONE' AND  
DOES NOT REPRESENT THE ACTUAL PERIMETER OF THE CONNECTOR. WHEN LAYING OUT A PCB BOARD  
FOR CONNECTORS STACKED TOGETHER, USE A 1.5mm PROGRESSION.

QUALITY SYMBOLS	GENERAL TOLERANCES (UNLESS SPECIFIED)	DIMENSION STYLE	SCALE	DESIGN UNITS	THIRD ANGLE PROJECTION
∇=0 ∇=0 ∇=0	mm INCH 4 PLACES ± --- ± --- 3 PLACES ± --- ± --- 2 PLACES ± 0.13 ± --- 1 PLACE ± 0.25 ± --- 0 PLACE ± ± ---	MM ONLY DRAWN BY DATE MSANDBERG 2007/12/26 CHECKED BY DATE JLAURX 2007/12/26 APPROVED BY DATE JLAURX 2010/02/22	4:1	METRIC	
REVISED (NUMBER) EC NO. UCP2014-0887 DRAWN BY INGHAM CHECKED BY LAURX APPROVED BY LAURX DATE 2010/02/22	MATERIAL NO. SEE TABLE	TITLE IMPACT 6 PAIR HEADER LEFT GUIDED ASSEMBLY SALES DRAWING	DOCUMENT NO. SD-76145-002	SHEET NO. 1 OF 3	
DRAFT WHERE APPLICABLE MUST REMAIN WITHIN DIMENSIONS THIS DRAWING CONTAINS INFORMATION THAT IS PROPRIETARY TO MOLEX INCORPORATED AND SHOULD NOT BE USED WITHOUT WRITTEN PERMISSION					

PART NUMBER LOGIC

76145-\*\*\*

MODULE TYPE

- 3 = GUIDE LEFT, TIN
- 7 = GUIDE LEFT END WALL, TIN

# OF COLUMNS

- 1 = 10 COL
- 6 = 16 COL
- 7 = 14 COL

PIN LENGTH (P)

- 3 = 4.50 (SHORT COMPLIANT, 0.46±0.05 PTH)
- 4 = 4.90 (SHORT COMPLIANT, 0.46±0.05 PTH)
- 5 = 5.50 (SHORT COMPLIANT, 0.46±0.05 PTH)
- 6 = 4.50 (MICRO COMPLIANT, 0.39±0.05 PTH)
- 7 = 4.90 (MICRO COMPLIANT, 0.39±0.05 PTH)
- 8 = 5.50 (MICRO COMPLIANT, 0.39±0.05 PTH)

KEY ORIENTATION

- 0 = NO KEY
- 1 = A
- 2 = B
- 3 = C
- 4 = D
- 5 = E
- 6 = F
- 7 = G
- 8 = H

PART NUMBER TABLE

MATERIAL NUMBER	# OF COLUMNS	# OF DIFF PAIR	DIM 'A'	DIM 'B'	
76145-1**	10	60	26.9	17.10	GUIDE LEFT END WALL OPTION
76145-7**	14	84	34.5	24.70	
76145-6**	16	96	38.3	28.50	

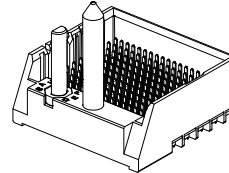

GUIDE LEFT  
END WALL  
OPTION

MATERIAL NUMBER	# OF COLUMNS	# OF DIFF PAIR	DIM 'A'	DIM 'B'	
76145-1**	10	60	25.5	17.10	GUIDE LEFT OPEN WALL OPTION
76145-7**	14	84	33.1	24.70	
76145-6**	16	96	36.9	28.50	

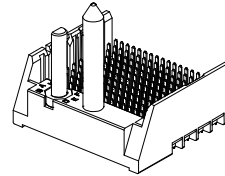

GUIDE LEFT  
OPEN WALL  
OPTION

SEE SHEET 1 EC NO: UCP2014-0887 DRAWN BY: B. INDIAN 2013/08/25 CHKD: JLAURX 2013/08/25 APPR: JLAURX 2013/09/25	QUALITY SYMBOLS ∇=0 ∇=0 ∇=0	GENERAL TOLERANCES (UNLESS SPECIFIED)		DIMENSION STYLE		SCALE	DESIGN UNITS	THIRD ANGLE PROJECTION	
				MM ONLY		2:1	METRIC		
		4 PLACES ± --- ± ---		DRAWN BY: MSANDBERG		DATE: 2007/12/26		TITLE IMPACT 6 PAIR HEADER LEFT GUIDED ASSEMBLY SALES DRAWING 	
		3 PLACES ± --- ± ---		CHECKED BY: JLAURX		DATE: 2007/12/26			
2 PLACES ± 0.13 ± ---		APPROVED BY: JLAURX		DATE: 2010/02/22					
1 PLACE ± 0.25 ± ---		MATERIAL NO.		DOCUMENT NO.					
0 PLACE ± ±		ANGULAR ±1/2°		SEE TABLE		SD-76145-002		SHEET NO. 2 OF 3	
DRAFT WHERE APPLICABLE MUST REMAIN WITHIN DIMENSIONS		SIZE C		THIS DRAWING CONTAINS INFORMATION THAT IS PROPRIETARY TO MOLEX INCORPORATED AND SHOULD NOT BE USED WITHOUT WRITTEN PERMISSION					

IMPACT 6 PAIR  
BOARD RELATIONSHIPS

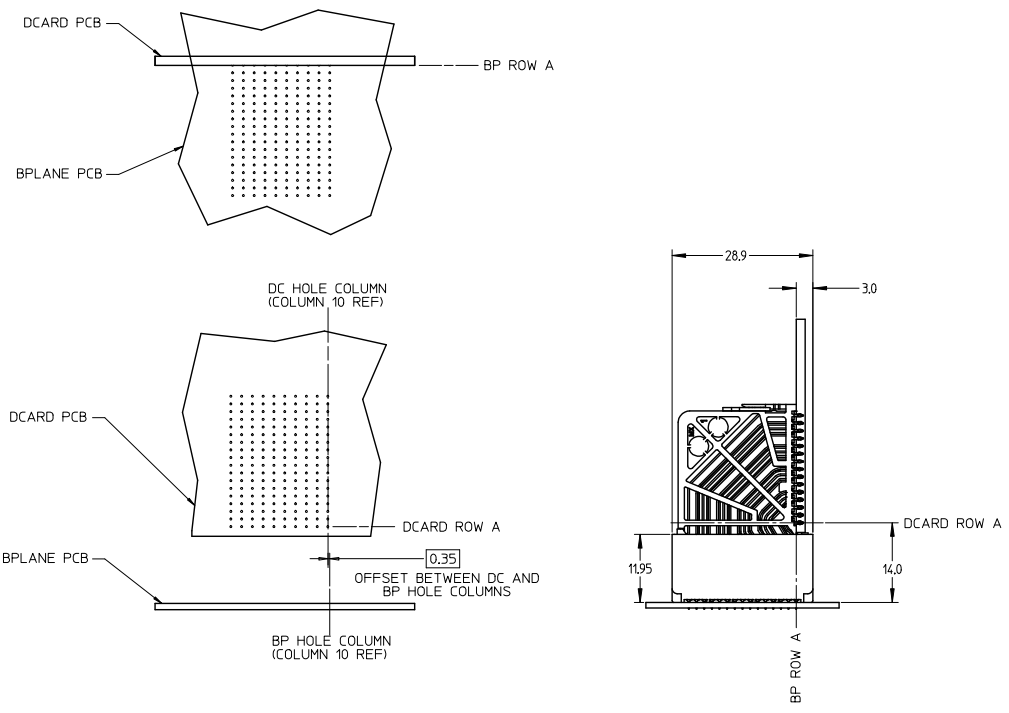

SEE SHEET 1 IEC NO: UCPC2014-0887 DRAWN: BINGHAM 2013/08/29 CHKD: LAURX 2013/08/29 APPR: LAURX 2013/09/23	QUALITY SYMBOLS ∇=0 ∇=0 ∇=0	GENERAL TOLERANCES (UNLESS SPECIFIED)		DIMENSION STYLE MM ONLY		SCALE 2:1	DESIGN UNITS METRIC	THIRD ANGLE PROJECTION
		4 PLACES ± --- ± --- 3 PLACES ± --- ± --- 2 PLACES ± 0.13 ± --- 1 PLACE ± 0.25 ± --- 0 PLACE ± ±	mm INCH DRAWN BY MSANDBERG 2007/12/26 CHECKED BY JLAURX 2007/12/26 APPROVED BY JLAURX 2010/02/22	TITLE IMPACT 6 PAIR HEADER LEFT GUIDED ASSEMBLY SALES DRAWING		MATERIAL NO. SEE TABLE		DOCUMENT NO. SD-76145-002
REV G1	DESCRIPTION	ANGULAR ±1/2° DRAFT WHERE APPLICABLE MUST REMAIN WITHIN DIMENSIONS		THIS DRAWING CONTAINS INFORMATION THAT IS PROPRIETARY TO MOLEX INCORPORATED AND SHOULD NOT BE USED WITHOUT WRITTEN PERMISSION		molex		