

Excellent Integrated System Limited

Stocking Distributor

Click to view price, real time Inventory, Delivery & Lifecycle Information:

[Molex Connector Corporation](#)

[0761554604](#)

For any questions, you can email us directly:

sales@integrated-circuit.com

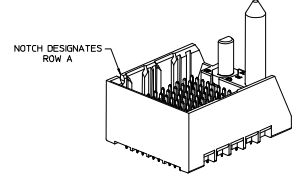
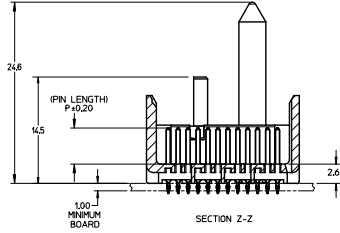
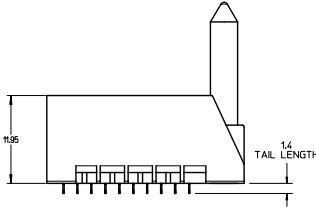
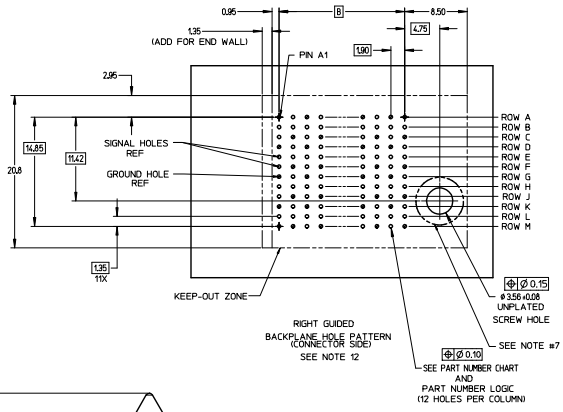
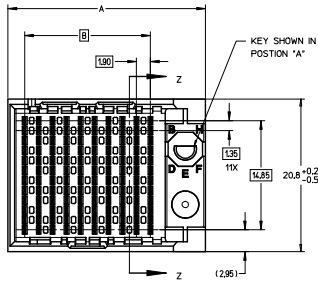

- NOTES:
1. MATERIALS: HOUSING - LIQUID CRYSTAL POLYMER (LCP) GLASS-FILLED, UL94V-0
TERMINALS - HIGH PERFORMANCE COPPER ALLOY
 2. FINISH: 30μ MN GOLD IN CONTACT AREA, SELECTIVE TN ON PCB TAILS, NICKEL OVERALL.
 3. REFER TO MOLEX PRODUCT SPECIFICATION PS-76060-999 FOR PERFORMANCE SPECIFICATIONS AND ADDITIONAL PCB INFORMATION.
 4. THIS PART CONFORMS TO CLASS B REQUIREMENTS OF MOLEX COSMETIC SPEC PS-45499-002.
 5. PACKAGE PER PK-70873-757.
 6. SEE SHEETS 2 & 3 FOR PART NUMBERS AND BOARD RELATIONSHIPS.
 7. FOR GROUNDED GUIDE PINS USE DIA. 3.56 ± 0.08 (PTH) DIA. 3.66 (DRILL) AND DIA. 6.5 (PAD).
 8. MATES WITH IMPACT DC SERIES NO. 76160.
 9. KEEP OUT ZONE FOR BP HOUSING LENGTH INCLUDES AN ADDITIONAL 10MM TO ACCOMMODATE FOR SPACE REQUIRED BY DC FRONT HOUSING.
 10. REFER TO MOLEX PCB ROUTING GUIDE AS-76060-990 FOR ANTI PAD AND ROUTING RECOMMENDATIONS.
 11. CONNECTORS SUPPLIED WITH A 2-56 UNC-2A SCREW.
 12. THESE DIMENSIONS REPRESENT THE AREA NEEDED TO ACCOMMODATE CONNECTOR INSERTION AND REPAIR ON THE PC BOARD. THIS IS REFERRED TO AS THE "CONNECTOR KEEP OUT ZONE" AND DOES NOT REPRESENT THE ACTUAL PERIMETER OF THE CONNECTOR. WHEN LAYING OUT A PC BOARD FOR CONNECTORS STACKED TOGETHER, USE A 10mm PROGRESSION.

CONVERT TO LEAD-FREE EC NS: ICF2303-2078 DRAWN: IBARRA 2007/11/26 CHECKED: B. NGUYEN 2007/12/18 APPROVED: J. NGUYEN 2007/12/21 (REV)	QUALITY SYMBOLS	GENERAL TOLERANCES (UNLESS SPECIFIED)	DIMENSION STYLE MM ONLY	SCALE 4:1	DESIGN UNITS METRIC	THIRD ANGLE PROJECTION	
	$\nabla=0$ $\nabla=0$ $\nabla=0$	mm INCH 4 PLACES ± --- ± --- 3 PLACES ± --- ± --- 2 PLACES ± 0.13 ± --- 1 PLACE ± 0.25 ± --- 0 PLACE ± ± ---	DRAWN BY DATE MSANDBERG 2007/11/26 CHECKED BY DATE JLAURX 2007/11/27 APPROVED BY DATE JLAURX 2010/10/15	MATERIAL NO. SEE TABLE	DOCUMENT NO. SD-76155-003	SHEET NO. 1 OF 3	TITLE IMPACT 4 PAIR HEADER RIGHT GUIDED ASSEMBLY SALES DRAWING molex
	DRAFT WHERE APPLICABLE MUST REMAIN WITHIN DIMENSIONS		THIS DRAWING CONTAINS INFORMATION THAT IS PROPRIETARY TO MOLEX INCORPORATED AND SHOULD NOT BE USED WITHOUT WRITTEN PERMISSION				
	INCORPORATED AND SHOULD NOT BE USED WITHOUT WRITTEN PERMISSION						

PART NUMBER TABLE

MATERIAL NUMBER	# OF COLUMNS	# OF DIFF PAIR	DIM 'A'	DIM 'B'	GUIDE RIGHT END WALL OPTION
76155-*3**	6	24	19.3	9.50	
76155-*8**	8	32	23.1	13.30	
76155-*1**	10	40	26.9	17.10	
76155-*6**	16	64	38.3	28.50	

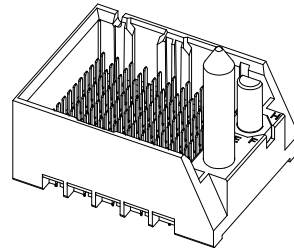

GUIDE RIGHT
END WALL
OPTION

MATERIAL NUMBER	# OF COLUMNS	# OF DIFF PAIR	DIM 'A'	DIM 'B'	GUIDE RIGHT OPEN WALL OPTION
76155-*3**	6	24	17.9	9.50	
76155-*8**	8	32	21.7	13.30	
76155-*1**	10	40	25.5	17.10	
76155-*6**	16	64	36.9	28.50	

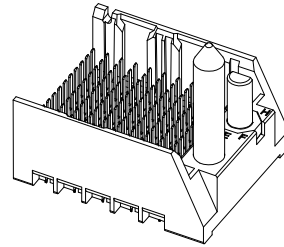

GUIDE RIGHT
OPEN WALL
OPTION

PART NUMBER LOGIC

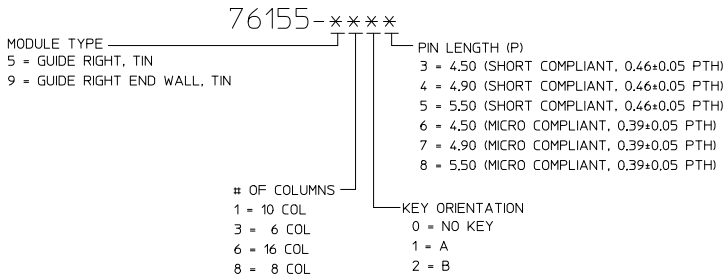

SEE SHEET 1 EC NO: UCPE2013-2078 DRAWN BY: IBARRA 2012/11/28 CHKD BY: NIGRAM 2012/12/18 APPR: MILLER 2012/12/13	QUALITY SYMBOLS ∇=0 ∇=0 ∇=0	GENERAL TOLERANCES (UNLESS SPECIFIED)		DIMENSION STYLE MM ONLY		SCALE 3:1	DESIGN UNITS METRIC	THIRD ANGLE PROJECTION	
				mm	INCH	DRAWN BY MSANDBERG	DATE 2007/19/07	TITLE IMPACT 4 PAIR HEADER RIGHT GUIDED ASSEMBLY SALES DRAWING	
		4 PLACES ± --- ± ---				CHECKED BY JLAURX	DATE 2007/19/07	molex	
		3 PLACES ± --- ± ---				APPROVED BY JLAURX	DATE 2010/10/15	DOCUMENT NO. SD-76155-003	SHEET NO. 2 OF 3
2 PLACES ± 0.13 ± ---				ANGULAR ± 1/2°		DRAFT WHERE APPLICABLE MUST REMAIN WITHIN DIMENSIONS			
1 PLACE ± 0.25 ± ---				MATERIAL NO.		THIS DRAWING CONTAINS INFORMATION THAT IS PROPRIETARY TO MOLEX INCORPORATED AND SHOULD NOT BE USED WITHOUT WRITTEN PERMISSION			
0 PLACE ± ±				SIZE C					

IMPACT 4 PAIR
BOARD RELATIONSHIPS

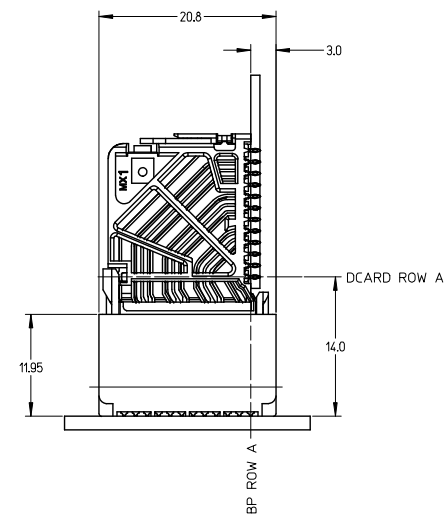
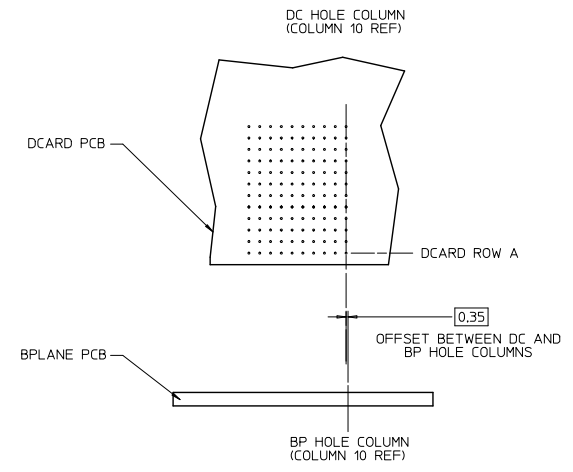
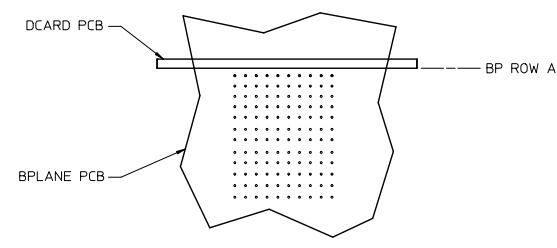

SEE SHEET 1 EC NO: UCP2019-2078 DRWNT: IBARRA 2012/11/28 CHKD: BINGHAM 2012/12/18 APPR: MILLER 2012/12/31 REV:	QUALITY SYMBOLS	GENERAL TOLERANCES (UNLESS SPECIFIED)	DIMENSION STYLE	SCALE	DESIGN UNITS	THIRD ANGLE PROJECTION
	∇=0 ∇=0 ∇=0	mm INCH 4 PLACES ± --- ± --- 3 PLACES ± --- ± --- 2 PLACES ± 0.13 ± --- 1 PLACE ± 0.25 ± --- 0 PLACE ± ±	MM ONLY	2:1	METRIC	DRAWN BY DATE MSANDBERG 2007/19/07 CHECKED BY DATE JLAURX 2007/19/07 APPROVED BY DATE JLAURX 2010/10/15
ANGULAR ±1/2° DRAFT WHERE APPLICABLE MUST REMAIN WITHIN DIMENSIONS		SEE TABLE MATERIAL NO. DOCUMENT NO.		TITLE IMPACT 4 PAIR HEADER RIGHT GUIDED ASSEMBLY SALES DRAWING molex SD-76155-003		SHEET NO. 3 OF 3