

Excellent Integrated System Limited

Stocking Distributor

Click to view price, real time Inventory, Delivery & Lifecycle Information:

[Molex Connector Corporation](#)

[0781271169](#)

For any questions, you can email us directly:

sales@integrated-circuit.com

10 9 8 7 6 5 4 3 2 1

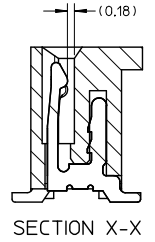
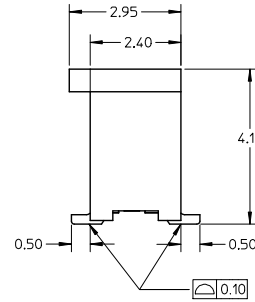
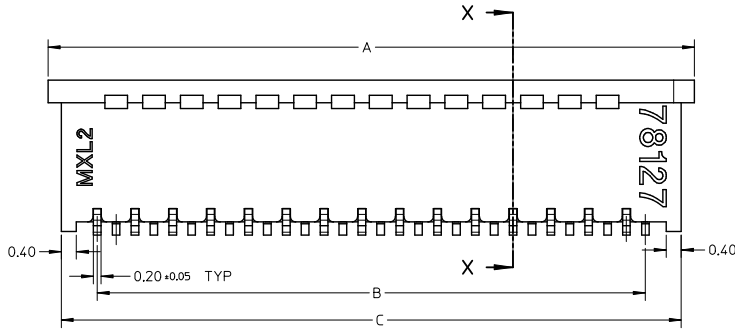
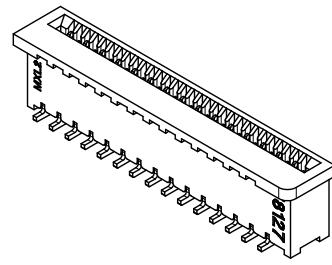
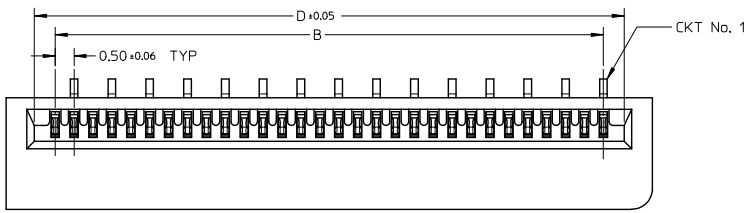

NOTE:

1. MATERIAL:
HOUSING: PA46 GLASS FILLED, UL94V-0, COLOR: NATURAL
TERMINAL: COPPER ALLOY
2. PLATING:
1) 0.10 μm MIN. GOLD PLATING OVER NICKEL PLATING OVERALL
2) 1-3 μm TIN-BISMUTH PLATING OVER NICKEL PLATING OVERALL
3. PRODUCT SPECIFICATION: PS-78119-001
4. PRODUCT ARE PACKED IN TAPE & REEL.

REVISED EC NO: J2013-0629 DRAWN: MORISHITA 2012/11/30 CHKD: TAKAHASHI 2012/11/30 APP: KINOKAWA 2012/12/11	DESCRIPTION REV B	QUALITY SYMBOLS	GENERAL TOLERANCES (UNLESS SPECIFIED)	DIMENSION STYLE	SCALE	DESIGN UNITS	THIRD ANGLE PROJECTION
		▽=0	mm INCH	MM ONLY	NTS	METRIC	
		▽=0	4 PLACES ± --- ± ---	DRAWN BY DATE	TITLE		
		▽=0	3 PLACES ± --- ± ---	YLO1A0 2006/05/05	0.50MM PITCH, FPC CONN. NON-ZIF, SMT		
		2 PLACES ± 0.15 ± ---	CHECKED BY DATE				
		1 PLACE ± --- ± ---	BOKOK 2006/06/06				
		0 PLACE ± --- ± ---	APPROVED BY DATE				
		ANGULAR ± 3°	PTL IM 2006/06/06				
		DRAFT WHERE APPLICABLE MUST REMAIN WITHIN DIMENSIONS	MATERIAL NO.	SEE TABLE	DOCUMENT NO.	SD-78127-001	SHEET NO. 1 OF 7
			SIZE A3	THIS DRAWING CONTAINS INFORMATION THAT IS PROPRIETARY TO MOLEX INCORPORATED AND SHOULD NOT BE USED WITHOUT WRITTEN PERMISSION			

9 8 7 6 5 4 3 2 1

10 9 8 7 6 5 4 3 2 1

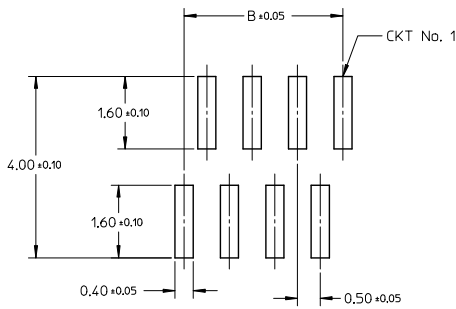

RECOMMENDED PCB LAYOUT

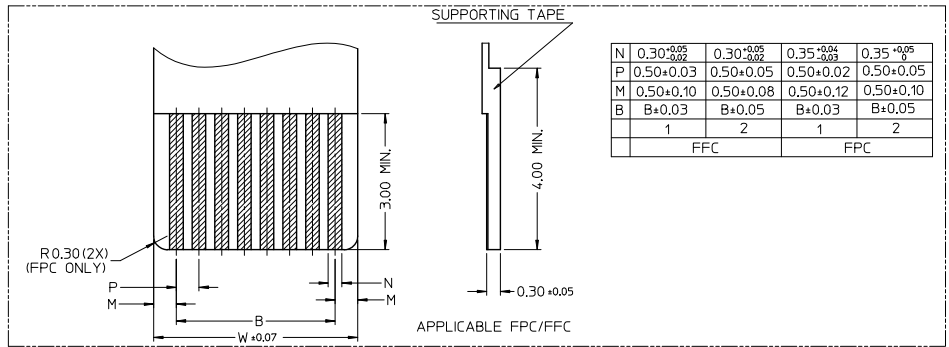

N	0.30 ^{+0.05} / _{-0.02}	0.30 ^{+0.05} / _{-0.02}	0.35 ^{+0.04} / _{-0.03}	0.35 ^{+0.05} / ₀
P	0.50±0.03	0.50±0.05	0.50±0.02	0.50±0.05
M	0.50±0.10	0.50±0.08	0.50±0.12	0.50±0.10
B	B±0.03	B±0.05	B±0.03	B±0.05
	1	2	1	2
	FFC		FPC	

REVISED EC NO: J2013-0629 DRAWN: MORI SHITA 2012/11/30 CHECK: TAKAHASHI 2012/11/30 APPR: MORIKAWA 2012/12/11	QUALITY SYMBOLS	GENERAL TOLERANCES (UNLESS SPECIFIED)		DIMENSION STYLE		SCALE	DESIGN UNITS	THIRD ANGLE PROJECTION		
	$\nabla=0$ $\nabla=0$ $\nabla=0$	4 PLACES	mm	INCH	MM ONLY		NTS	METRIC	TITLE 0.50MM PITCH, FPC CONN. NON-ZIF, SMT	
		3 PLACES	±---	±---	DRAWN BY	DATE			MATERIAL NO. SEE TABLE	
		2 PLACES	±0.15	±---	CHECKED BY	DATE			DOCUMENT NO. SD-78127-001	
	1 PLACE	±---	±---	APPROVED BY	DATE			SHEET NO. 2 OF 7		
	0 PLACE	±	±	PTL IM 2006/06/06				THIS DRAWING CONTAINS INFORMATION THAT IS PROPRIETARY TO MOLEX INCORPORATED AND SHOULD NOT BE USED WITHOUT WRITTEN PERMISSION		
		ANGULAR ± 3°								
		DRAFT WHERE APPLICABLE MUST REMAIN WITHIN DIMENSIONS								

9 8 7 6 5 4 3 2 1

10 9 8 7 6 5 4 3 2 1

GOLD PLATING TERMINAL ASSEMBLY PART NUMBERS

ASSY P/N W/O PACKAGING	CKT	DIM A	DIM B	DIM C	DIM D	PLATING TYPE
78127-0108	10	7.10	4.50	6.40	5.60	1
78127-0118	11	7.60	5.00	6.90	6.10	
78127-0128	12	8.10	5.50	7.40	6.60	
78127-0138	13	8.60	6.00	7.90	7.10	
78127-0148	14	9.10	6.50	8.40	7.60	
78127-0158	15	9.60	7.00	8.90	8.10	
78127-0168	16	10.10	7.50	9.40	8.60	
78127-0178	17	10.60	8.00	9.90	9.10	
78127-0188	18	11.10	8.50	10.40	9.60	
78127-0198	19	11.60	9.00	10.90	10.10	
78127-0208	20	12.10	9.50	11.40	10.60	
78127-0218	21	12.60	10.00	11.90	11.10	
78127-0228	22	13.10	10.50	12.40	11.60	
78127-0238	23	13.60	11.00	12.90	12.10	
78127-0248	24	14.10	11.50	13.40	12.60	
78127-0258	25	14.60	12.00	13.90	13.10	
78127-0268	26	15.10	12.50	14.40	13.60	
78127-0278	27	15.60	13.00	14.90	14.10	
78127-0288	28	16.10	13.50	15.40	14.60	
78127-0298	29	16.60	14.00	15.90	15.10	
78127-0308	30	17.10	14.50	16.40	15.60	

ASSY P/N W/O PACKAGING	CKT	DIM A	DIM B	DIM C	DIM D	PLATING TYPE
78127-0318	31	17.60	15.00	16.90	16.10	1
78127-0328	32	18.10	15.50	17.40	16.60	
78127-0338	33	18.60	16.00	17.90	17.10	
78127-0348	34	19.10	16.50	18.40	17.60	
78127-0358	35	19.60	17.00	18.90	18.10	
78127-0368	36	20.10	17.50	19.40	18.60	
78127-0378	37	20.60	18.00	19.90	19.10	
78127-0388	38	21.10	18.50	20.40	19.60	
78127-0398	39	21.60	19.00	20.90	20.10	
78127-0408	40	22.10	19.50	21.40	20.60	

REVISED EC NO: J2013-0629 DRAWN: MORISHITA 2012/11/30 CHECKED: TAKAHASHI 2012/11/30 APPR: KIMURA 2012/11/11	QUALITY SYMBOLS 	GENERAL TOLERANCES (UNLESS SPECIFIED)		DIMENSION STYLE MM ONLY		SCALE NTS	DESIGN UNITS METRIC	THIRD ANGLE PROJECTION	
			mm	INCH	DRAWN BY	DATE	0.50MM PITCH, FPC CONN. NON-ZIF, SMT DOCUMENT NO. SD-78127-001 SHEET NO. 3 OF 7		
		4 PLACES	± ---	± ---	YLO1A0	2006/05/05			
		3 PLACES	± ---	± ---	CHECKED BY	DATE			
2 PLACES	± 0.15	± ---	BOKOK	2006/06/06					
1 PLACE	± ---	± ---	APPROVED BY	DATE					
0 PLACE	±	±	PTL IM	2006/06/06					
ANGULAR ± 3° DRAFT WHERE APPLICABLE MUST REMAIN WITHIN DIMENSIONS		MATERIAL NO. SEE TABLE							
		SIZE 		THIS DRAWING CONTAINS INFORMATION THAT IS PROPRIETARY TO MOLEX INCORPORATED AND SHOULD NOT BE USED WITHOUT WRITTEN PERMISSION					

9 8 7 6 5 4 3 2 1

10 9 8 7 6 5 4 3 2 1

TIN-BISMUTH PLATING TERMINAL ASSEMBLY PART NUMBERS

ASSY P/N W/O PACKAGING	CKT	DIM A	DIM B	DIM C	DIM D	PLATING TYPE
78127-0109	10	7.10	4.50	6.40	5.60	2
78127-0119	11	7.60	5.00	6.90	6.10	
78127-0129	12	8.10	5.50	7.40	6.60	
78127-0139	13	8.60	6.00	7.90	7.10	
78127-0149	14	9.10	6.50	8.40	7.60	
78127-0159	15	9.60	7.00	8.90	8.10	
78127-0169	16	10.10	7.50	9.40	8.60	
78127-0179	17	10.60	8.00	9.90	9.10	
78127-0189	18	11.10	8.50	10.40	9.60	
78127-0199	19	11.60	9.00	10.90	10.10	
78127-0209	20	12.10	9.50	11.40	10.60	
78127-0219	21	12.60	10.00	11.90	11.10	
78127-0229	22	13.10	10.50	12.40	11.60	
78127-0239	23	13.60	11.00	12.90	12.10	
78127-0249	24	14.10	11.50	13.40	12.60	
78127-0259	25	14.60	12.00	13.90	13.10	
78127-0269	26	15.10	12.50	14.40	13.60	
78127-0279	27	15.60	13.00	14.90	14.10	
78127-0289	28	16.10	13.50	15.40	14.60	
78127-0299	29	16.60	14.00	15.90	15.10	
78127-0309	30	17.10	14.50	16.40	15.60	

ASSY P/N W/O PACKAGING	CKT	DIM A	DIM B	DIM C	DIM D	PLATING TYPE
78127-0319	31	17.60	15.00	16.90	16.10	2
78127-0329	32	18.10	15.50	17.40	16.60	
78127-0339	33	18.60	16.00	17.90	17.10	
78127-0349	34	19.10	16.50	18.40	17.60	
78127-0359	35	19.60	17.00	18.90	18.10	
78127-0369	36	20.10	17.50	19.40	18.60	
78127-0379	37	20.60	18.00	19.90	19.10	
78127-0389	38	21.10	18.50	20.40	19.60	
78127-0399	39	21.60	19.00	20.90	20.10	
78127-0409	40	22.10	19.50	21.40	20.60	

REVISED EC NO. J2013-0629 DRAWN: MORISHITA 2012/11/30 CHECKED: AKAHASHI 2012/11/30 APPR: MORIKAWA 2012/12/11	QUALITY SYMBOLS $\nabla=0$ $\nabla=0$ $\nabla=0$	GENERAL TOLERANCES (UNLESS SPECIFIED)		DIMENSION STYLE MM ONLY		SCALE NTS	DESIGN UNITS METRIC	THIRD ANGLE PROJECTION	
		4 PLACES ± --- ± ---	DRAWN BY YLQ1A0	DATE 2006/05/05	TITLE 0.50MM PITCH, FPC CONN. NON-ZIF, SMT				
		3 PLACES ± --- ± ---	CHECKED BY BOKOK	DATE 2006/06/06					
		2 PLACES ± 0.15 ± ---	APPROVED BY PTLIM	DATE 2006/06/06					
1 PLACE ± --- ± ---	MATERIAL NO. SEE TABLE		DOCUMENT NO. SD-78127-001	SHEET NO. 4 OF 7					
0 PLACE ± ±	ANGULAR ± 3 °		DRAFT WHERE APPLICABLE MUST REMAIN WITHIN DIMENSIONS						
		SIZE 		THIS DRAWING CONTAINS INFORMATION THAT IS PROPRIETARY TO MOLEX INCORPORATED AND SHOULD NOT BE USED WITHOUT WRITTEN PERMISSION					

9 8 7 6 5 4 3 2 1

10 9 8 7 6 5 4 3 2 1

EMBOSSED TYPE A

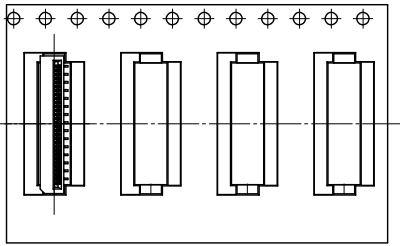

CUSTOMER
PULL OUT DIRECTION

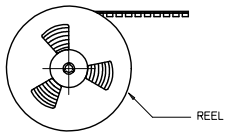

NOTES:

1. LEADER AND TRAILER TAPE

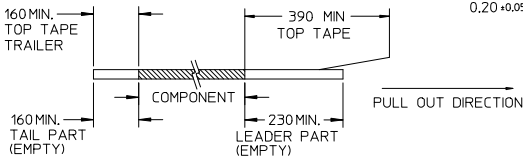

2. PEELING OFF FORCE OF THE TOP TAPE: 20-80gf.
(PEELING DIRECTION AS SHOWN IN FOLLOWING FIGURE)

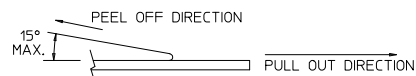

- 3. PACKAGING STANDARD IS AS PER EIA-481.
- 4. TAPE & REEL QUANTITY = 1000 PCS/REEL

EMBOSSED TYPE B

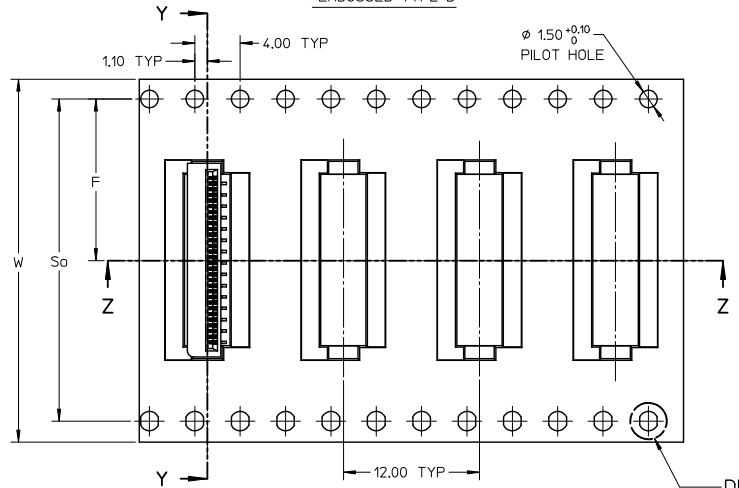

SECTION Y-Y

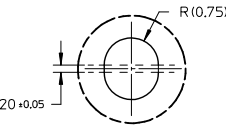

DETAIL 1

SECTION Z-Z

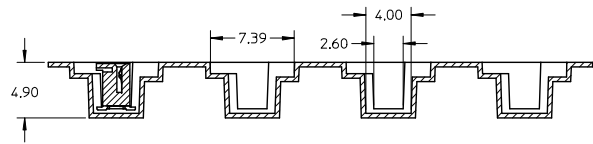

REVISED EC NO. 2013-0629 DRAWN: MORISHITA 2012/11/30 CHECK: TAKAHASHI 2012/11/30 APPR: KIMURAKAWA 2012/12/11	QUALITY SYMBOLS ∇=0 ∇=0 ∇=0	GENERAL TOLERANCES (UNLESS SPECIFIED)		DIMENSION STYLE MM ONLY		SCALE NTS	DESIGN UNITS METRIC	THIRD ANGLE PROJECTION		
		4 PLACES ± --- ± ---	3 PLACES ± --- ± ---	2 PLACES ± 0.15 ± ---	1 PLACE ± --- ± ---	0 PLACE ± ±	DRAWN BY YLQIAO		DATE 2006/05/05	TITLE 0.50MM PITCH, FPC CONN. NON-ZIF, SMT
		ANGULAR ± 3°		DRAFT WHERE APPLICABLE MUST REMAIN WITHIN DIMENSIONS		MATERIAL NO. SEE TABLE	APPROVED BY PTL IM		DATE 2006/06/06	DOCUMENT NO. SD-78127-001
		SIZE A3		THIS DRAWING CONTAINS INFORMATION THAT IS PROPRIETARY TO MOLEX INCORPORATED AND SHOULD NOT BE USED WITHOUT WRITTEN PERMISSION						SHEET NO. 5 OF 7

9 8 7 6 5 4 3 2 1

10 9 8 7 6 5 4 3 2 1

GOLD PLATING TERMINAL ASSEMBLY PART NUMBERS

ASSY P/N PACKED IN T&R	ASSY P/N W/O PACKAGING	CKT	W	So	F	Bo	B	EMBOSSED TYPE
78127-1108	78127-0108	10	24.00	-	11.50	7.40	5.10	A
78127-1118	78127-0118	11	24.00	-	11.50	7.90	5.60	
78127-1128	78127-0128	12	24.00	-	11.50	8.40	6.10	
78127-1138	78127-0138	13	24.00	-	11.50	8.90	6.60	
78127-1148	78127-0148	14	24.00	-	11.50	9.40	7.10	
78127-1158	78127-0158	15	24.00	-	11.50	9.90	7.60	
78127-1168	78127-0168	16	24.00	-	11.50	10.40	8.10	
78127-1178	78127-0178	17	24.00	-	11.50	10.90	8.60	
78127-1188	78127-0188	18	24.00	-	11.50	11.40	9.10	
78127-1198	78127-0198	19	24.00	-	11.50	11.90	9.60	
78127-1208	78127-0208	20	24.00	-	11.50	12.40	10.10	
78127-1218	78127-0218	21	32.00	28.40	14.20	12.90	10.60	B
78127-1228	78127-0228	22	32.00	28.40	14.20	13.40	11.10	
78127-1238	78127-0238	23	32.00	28.40	14.20	13.90	11.60	
78127-1248	78127-0248	24	32.00	28.40	14.20	14.40	12.10	
78127-1258	78127-0258	25	32.00	28.40	14.20	14.90	12.60	
78127-1268	78127-0268	26	32.00	28.40	14.20	15.40	13.10	
78127-1278	78127-0278	27	32.00	28.40	14.20	15.90	13.60	
78127-1288	78127-0288	28	32.00	28.40	14.20	16.40	14.10	
78127-1298	78127-0298	29	32.00	28.40	14.20	16.90	14.60	
78127-1308	78127-0308	30	32.00	28.40	14.20	17.40	15.10	

ASSY P/N PACKED IN T&R	ASSY P/N W/O PACKAGING	CKT	W	So	F	Bo	B	EMBOSSED TYPE
78127-1318	78127-0318	31	32.00	28.40	14.20	17.90	15.60	B
78127-1328	78127-0328	32	32.00	28.40	14.20	18.40	16.10	
78127-1338	78127-0338	33	32.00	28.40	14.20	18.90	16.60	
78127-1348	78127-0348	34	32.00	28.40	14.20	19.40	17.10	
78127-1358	78127-0358	35	32.00	28.40	14.20	19.90	17.60	
78127-1368	78127-0368	36	32.00	28.40	14.20	20.40	18.10	
78127-1378	78127-0378	37	32.00	28.40	14.20	20.90	18.60	
78127-1388	78127-0388	38	32.00	28.40	14.20	21.40	19.10	
78127-1398	78127-0398	39	44.00	40.40	20.20	21.90	19.60	
78127-1408	78127-0408	40	44.00	40.40	20.20	22.40	20.10	

REVISED EC NO. J2013-0629 DRAWN: IMORISHITA 2012/11/30 CHECK: TAKAHASHI 2012/11/30 APPR: IMORIKAWA 2012/12/11	QUALITY SYMBOLS $\sqrt{\text{A}}=0$ $\sqrt{\text{B}}=0$ $\sqrt{\text{C}}=0$	GENERAL TOLERANCES (UNLESS SPECIFIED) <table border="1"> <tr><th></th><th>mm</th><th>INCH</th></tr> <tr><td>4 PLACES</td><td>± ---</td><td>± ---</td></tr> <tr><td>3 PLACES</td><td>± ---</td><td>± ---</td></tr> <tr><td>2 PLACES</td><td>± 0.15</td><td>± ---</td></tr> <tr><td>1 PLACE</td><td>± ---</td><td>± ---</td></tr> <tr><td>0 PLACE</td><td>±</td><td>±</td></tr> </table>		mm	INCH	4 PLACES	± ---	± ---	3 PLACES	± ---	± ---	2 PLACES	± 0.15	± ---	1 PLACE	± ---	± ---	0 PLACE	±	±	DIMENSION STYLE MM ONLY DRAWN BY: YLQIAO DATE: 2006/05/05 CHECKED BY: BOKOK DATE: 2006/06/06 APPROVED BY: PTLIM DATE: 2006/06/06	SCALE: NTS DESIGN UNITS: METRIC THIRD ANGLE PROJECTION	TITLE: 0.50MM PITCH, FPC CONN. NON-ZIF, SMT
		mm	INCH																				
	4 PLACES	± ---	± ---																				
	3 PLACES	± ---	± ---																				
2 PLACES	± 0.15	± ---																					
1 PLACE	± ---	± ---																					
0 PLACE	±	±																					
MATERIAL NO. SEE TABLE DRAFT WHERE APPLICABLE MUST REMAIN WITHIN DIMENSIONS	ANGULAR ± 3° DRAFT WHERE APPLICABLE MUST REMAIN WITHIN DIMENSIONS	DOCUMENT NO. SD-78127-001 SHEET NO. 6 OF 7																					
THIS DRAWING CONTAINS INFORMATION THAT IS PROPRIETARY TO MOLEX INCORPORATED AND SHOULD NOT BE USED WITHOUT WRITTEN PERMISSION																							
SIZE: A3																							

9 8 7 6 5 4 3 2 1

10 9 8 7 6 5 4 3 2 1

TIN-BISMUTH PLATING TERMINAL ASSEMBLY PART NUMBERS

ASSY P/N PACKED IN T&R	ASSY P/N W/O PACKAGING	CKT	W	So	F	Bo	B	EMBOSSED TYPE
78127-1109	78127-0109	10	24.00	-	11.50	7.40	5.10	A
78127-1119	78127-0119	11	24.00	-	11.50	7.90	5.60	
78127-1129	78127-0129	12	24.00	-	11.50	8.40	6.10	
78127-1139	78127-0139	13	24.00	-	11.50	8.90	6.60	
78127-1149	78127-0149	14	24.00	-	11.50	9.40	7.10	
78127-1159	78127-0159	15	24.00	-	11.50	9.90	7.60	
78127-1169	78127-0169	16	24.00	-	11.50	10.40	8.10	
78127-1179	78127-0179	17	24.00	-	11.50	10.90	8.60	
78127-1189	78127-0189	18	24.00	-	11.50	11.40	9.10	
78127-1199	78127-0199	19	24.00	-	11.50	11.90	9.60	
78127-1209	78127-0209	20	24.00	-	11.50	12.40	10.10	B
78127-1219	78127-0219	21	32.00	28.40	14.20	12.90	10.60	
78127-1229	78127-0229	22	32.00	28.40	14.20	13.40	11.10	
78127-1239	78127-0239	23	32.00	28.40	14.20	13.90	11.60	
78127-1249	78127-0249	24	32.00	28.40	14.20	14.40	12.10	
78127-1259	78127-0259	25	32.00	28.40	14.20	14.90	12.60	
78127-1269	78127-0269	26	32.00	28.40	14.20	15.40	13.10	
78127-1279	78127-0279	27	32.00	28.40	14.20	15.90	13.60	
78127-1289	78127-0289	28	32.00	28.40	14.20	16.40	14.10	
78127-1299	78127-0299	29	32.00	28.40	14.20	16.90	14.60	
78127-1309	78127-0309	30	32.00	28.40	14.20	17.40	15.10	

ASSY P/N PACKED IN T&R	ASSY P/N W/O PACKAGING	CKT	W	So	F	Bo	B	EMBOSSED TYPE
78127-1319	78127-0319	31	32.00	28.40	14.20	17.90	15.60	B
78127-1329	78127-0329	32	32.00	28.40	14.20	18.40	16.10	
78127-1339	78127-0339	33	32.00	28.40	14.20	18.90	16.60	
78127-1349	78127-0349	34	32.00	28.40	14.20	19.40	17.10	
78127-1359	78127-0359	35	32.00	28.40	14.20	19.90	17.60	
78127-1369	78127-0369	36	32.00	28.40	14.20	20.40	18.10	
78127-1379	78127-0379	37	32.00	28.40	14.20	20.90	18.60	
78127-1389	78127-0389	38	32.00	28.40	14.20	21.40	19.10	
78127-1399	78127-0399	39	44.00	40.40	20.20	21.90	19.60	
78127-1409	78127-0409	40	44.00	40.40	20.20	22.40	20.10	

REVISED EC NO: J2013-0629 DRAWN: MORI SHITA 2012/11/30 CHK: OKAKASHI 2012/11/30 APPR: MORIKAWA 2012/12/11	QUALITY SYMBOLS 	GENERAL TOLERANCES (UNLESS SPECIFIED)		DIMENSION STYLE MM ONLY		SCALE NTS	DESIGN UNITS METRIC	THIRD ANGLE PROJECTION	
		4 PLACES ± --- ± ---	3 PLACES ± --- ± ---	DRAWN BY YLQ1A0	DATE 2006/05/05	TITLE 0.50MM PITCH, FPC CONN. NON-ZIF, SMT			
		2 PLACES ± 0.15 ± ---	1 PLACE ± --- ± ---	CHECKED BY BOKOK	DATE 2006/06/06				
		0 PLACE ± ±	ANGULAR ± 3 °	APPROVED BY PTL IM	DATE 2006/06/06	MATERIAL NO. SEE TABLE	DOCUMENT NO. SD-78127-001	SHEET NO. 7 OF 7	

DRAFT WHERE APPLICABLE MUST REMAIN WITHIN DIMENSIONS

THIS DRAWING CONTAINS INFORMATION THAT IS PROPRIETARY TO MOLEX INCORPORATED AND SHOULD NOT BE USED WITHOUT WRITTEN PERMISSION

9 8 7 6 5 4 3 2 1