

Excellent Integrated System Limited

Stocking Distributor

Click to view price, real time Inventory, Delivery & Lifecycle Information:

[Diodes Incorporated](#)
[DMN2300UFD-7](#)

For any questions, you can email us directly:

sales@integrated-circuit.com



A Product Line of **ZETEX**
Diodes Incorporated



DMN2300UFD

20V N-CHANNEL ENHANCEMENT MODE MOSFET

Product Summary

$V_{(BR)DSS}$	$R_{DS(on)}$ Max	I_D max $T_A = 25^\circ C$ (Notes 4)
20V	200m Ω @ $V_{GS} = 4.5V$	1.73A
	260m Ω @ $V_{GS} = 2.5V$	1.50A
	400m Ω @ $V_{GS} = 1.8V$	1.27A
	500m Ω @ $V_{GS} = 1.5V$	1.15A

Description and Applications

This MOSFET has been designed to minimize the on-state resistance ($R_{DS(on)}$) and yet maintain superior switching performance, making it ideal for high efficiency power management applications.

- Load switch

Features and Benefits

- Low Gate Threshold Voltage
- Fast Switching Speed
- "Lead Free", RoHS Compliant (Note 1)
- Halogen and Antimony Free. "Green" Device (Note 2)
- ESD Protected Gate 2KV
- Qualified to AEC-Q101 Standards for High Reliability

Mechanical Data

- Case: X1-DFN1212-3
- Case Material: Molded Plastic, "Green" Molding Compound. UL Flammability Classification Rating 94V-0
- Moisture Sensitivity: Level 1 per J-STD-020
- Terminals: Finish – NiPdAu over Copper leadframe. Solderable per MIL-STD-202, Method 208
- Weight: 0.005 grams (approximate)



X1-DFN1212-3



Top View

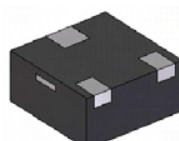

Bottom View

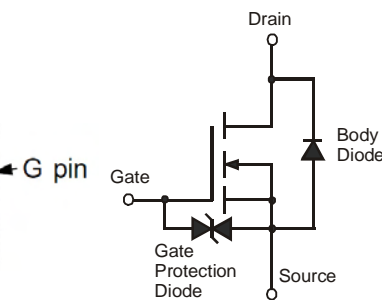

Equivalent Circuit

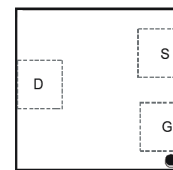

Pin-out Top view

Ordering Information (Note 3)

Part Number	Marking	Reel size (inches)	Tape width (mm)	Quantity per reel
DMN2300UFD-7	KS2	7	8	3000

- Notes:
1. No purposefully added lead
 2. Diodes Inc's "Green" policy can be found on our website at <http://www.diodes.com>.
 3. For packaging details, go to our website at <http://www.diodes.com>.

Marking Information

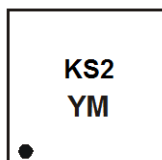

KS2 = Product Type Marking Code
 YM = Date Code Marking
 Y = Year (ex: Y = 2011)
 M = Month (ex: 9 = September)

Date Code Key

Year	2011	2012	2013	2014	2015	2016	2017
Code	Y	Z	A	B	C	D	E

Month	Jan	Feb	Mar	Apr	May	Jun	Jul	Aug	Sep	Oct	Nov	Dec
Code	1	2	3	4	5	6	7	8	9	O	N	D



A Product Line of **ZETEX**
Diodes Incorporated

DMN2300UFD

Maximum Ratings @T_A = 25°C unless otherwise specified

Characteristic		Symbol	Value	Unit
Drain-Source Voltage		V _{DSS}	20	V
Gate-Source Voltage		V _{GSS}	±8	V
Continuous Drain Current	Steady State	I _D	T _A = 25°C (Note 4)	1.73
			T _A = 85°C (Note 4)	1.34
			T _A = 25°C (Note 5)	1.21
Pulsed Drain Current (Note 6)		I _{DM}	6.0	A

Thermal Characteristics @T_A = 25°C unless otherwise specified

Characteristic		Symbol	Value	Unit
Power Dissipation	(Note 4)	P _D	0.96	W
	(Note 5)		0.47	W
Thermal Resistance, Junction to Ambient	(Note 4)	R _{θJA}	130	°C/W
	(Note 5)		265	°C/W
Operating and Storage Temperature Range		T _J , T _{STG}	-55 to +150	°C

- Notes:
4. For a device surface mounted on 15mm x 15mm x 1.6mm FR4 PCB with high coverage of 2oz copper, in still air conditions; the device is measured when operating in a steady-state condition.
 5. Same as note 4, except the device is mounted on minimum recommended pad layout.
 6. Device mounted on minimum recommended pad layout test board, 10μs pulse duty cycle = 1%.

Thermal Characteristics

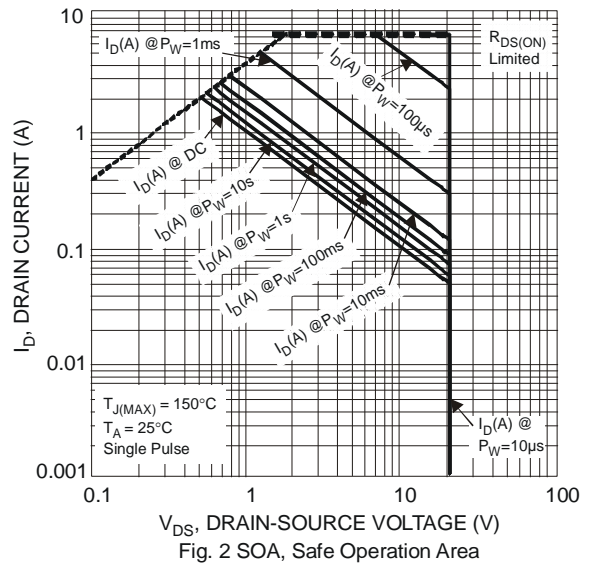
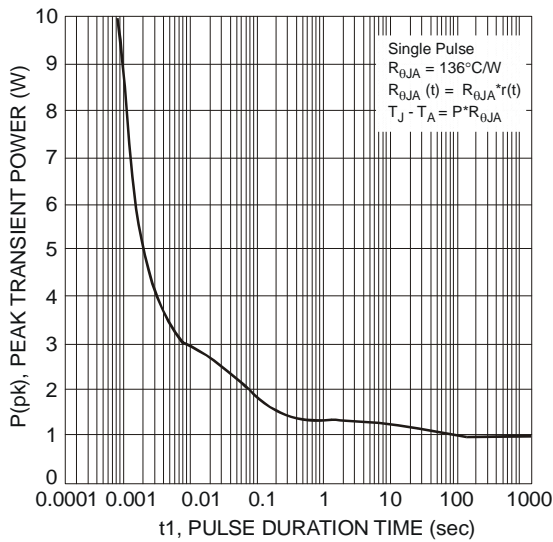



A Product Line of **ZETEX**
Diodes Incorporated

DMN2300UFD

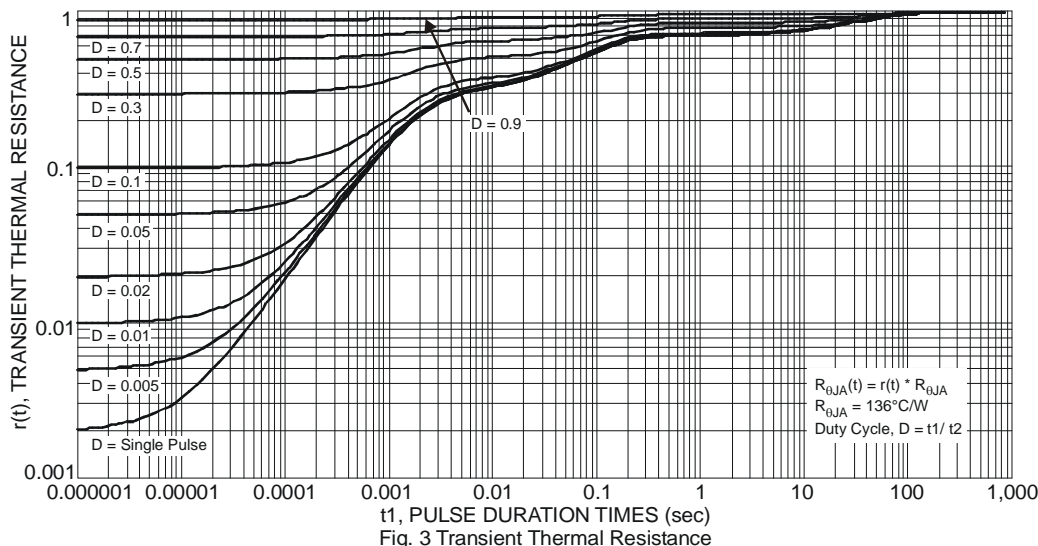

Electrical Characteristics @T_A = 25°C unless otherwise specified

Characteristic	Symbol	Min	Typ	Max	Unit	Test Condition
OFF CHARACTERISTICS (Note 7)						
Drain-Source Breakdown Voltage	BV _{DSS}	20	-	-	V	V _{GS} = 0V, I _D = 250μA
Zero Gate Voltage Drain Current T _J = 25°C	I _{DSS}	-	-	1	μA	V _{DS} = 20V, V _{GS} = 0V
Gate-Source Leakage	I _{GSS}	-	-	±10	μA	V _{GS} = ±8V, V _{DS} = 0V
ON CHARACTERISTICS (Note 7)						
Gate Threshold Voltage	V _{GS(th)}	0.45	-	0.95	V	V _{DS} = V _{GS} , I _D = 250μA
Static Drain-Source On-Resistance	R _{DS(on)}	-	-	200	mΩ	V _{GS} = 4.5V, I _D = 900mA
				260		V _{GS} = 2.5V, I _D = 800mA
				400		V _{GS} = 1.8V, I _D = 700mA
				500		V _{GS} = 1.5V, I _D = 200mA
Forward Transfer Admittance	Y _{fs}	40	-	-	mS	V _{DS} = 3V, I _D = 300mA
Diode Forward Voltage	V _{SD}	-	0.7	1.2	V	V _{GS} = 0V, I _S = 300mA
DYNAMIC CHARACTERISTICS						
Input Capacitance	C _{iss}	-	67.62	-	pF	V _{DS} = 25V, V _{GS} = 0V, f = 1.0MHz
Output Capacitance	C _{oss}	-	9.74	-	pF	
Reverse Transfer Capacitance	C _{rss}	-	7.58	-	pF	
Gate Resistance	R _g	-	68.51	-	Ω	V _{DS} = 0V, V _{GS} = 0V, f = 1MHz
Total Gate Charge (Note 8)	Q _g	-	0.89	2	nC	V _{GS} = 4.5V, V _{DS} = 15V, I _D = 1A
Gate-Source Charge	Q _{gs}	-	0.14	-	nC	
Gate-Drain Charge	Q _{gd}	-	0.16	-	nC	
Turn-On Delay Time	t _{D(on)}	-	4.92	-	ns	V _{DS} = 10V, I _D = 1A V _{GS} = 10V, R _G = 6Ω
Turn-On Rise Time	t _r	-	6.93	-	ns	
Turn-Off Delay Time	t _{D(off)}	-	21.71	-	ns	
Turn-Off Fall Time	t _f	-	10.62	-	ns	

Notes: 7. Short duration pulse test used to minimize self-heating effect.
 8. Guarantee by design.



A Product Line of **ZETEX**

DMN2300UFD

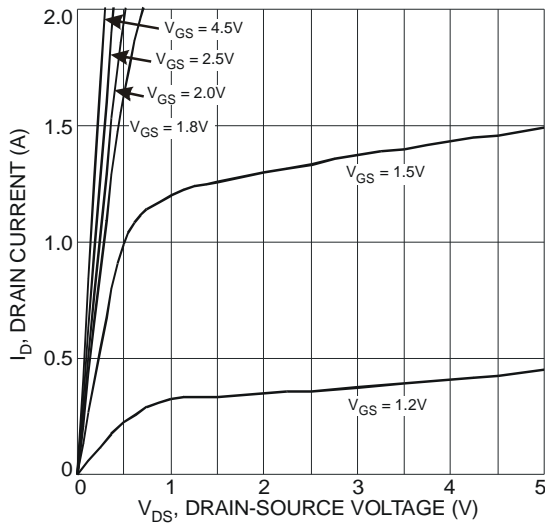

Fig. 4 Typical Output Characteristic

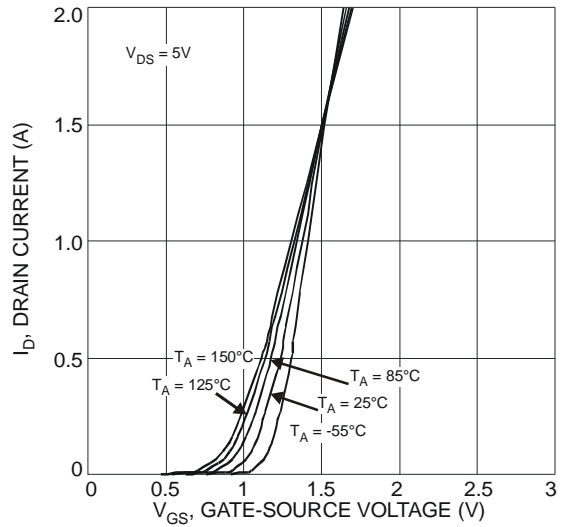

Fig. 5 Typical Transfer Characteristic

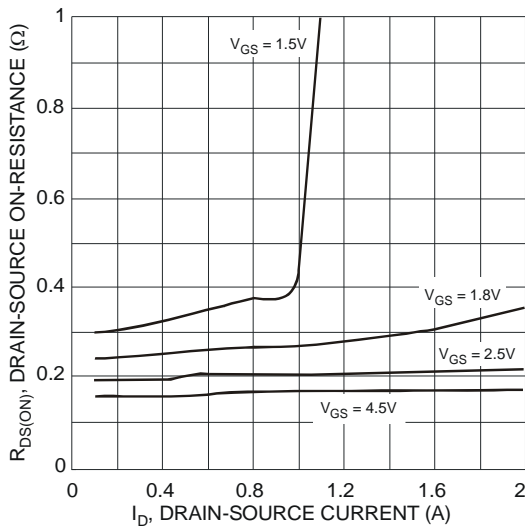

Fig. 6 Typical On-Resistance vs. Drain Current and Gate Voltage

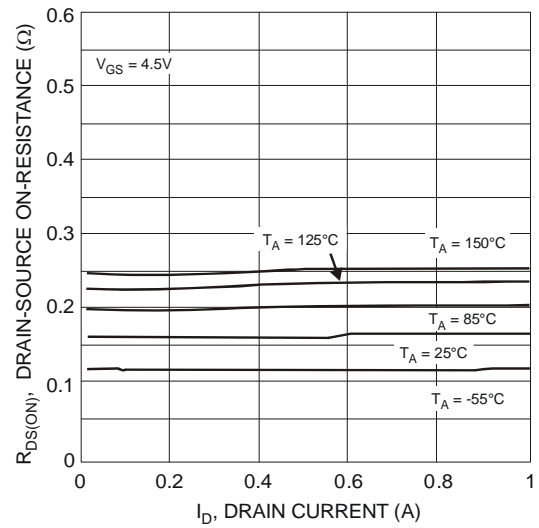

Fig. 7 Typical On-Resistance vs. Drain Current and Temperature

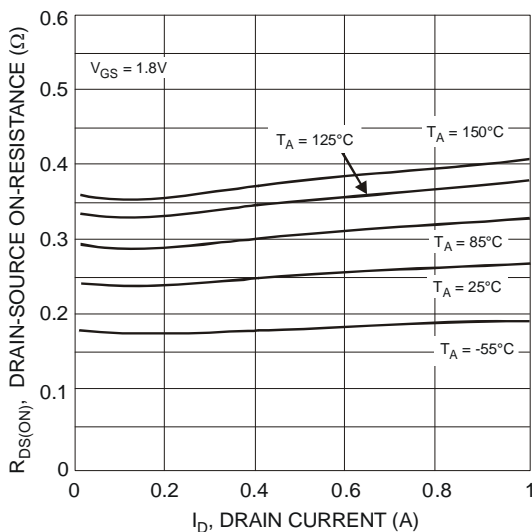

Fig. 8 Typical On-Resistance vs. Drain Current and Temperature

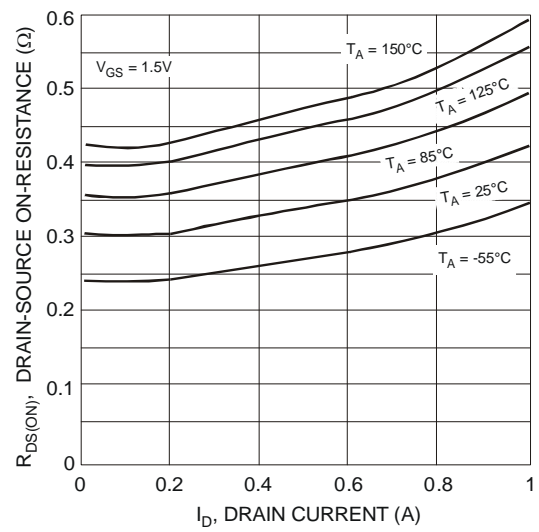

Fig. 9 Typical On-Resistance vs. Drain Current and Temperature



A Product Line of **ZETEX**
Diodes Incorporated

DMN2300UFD

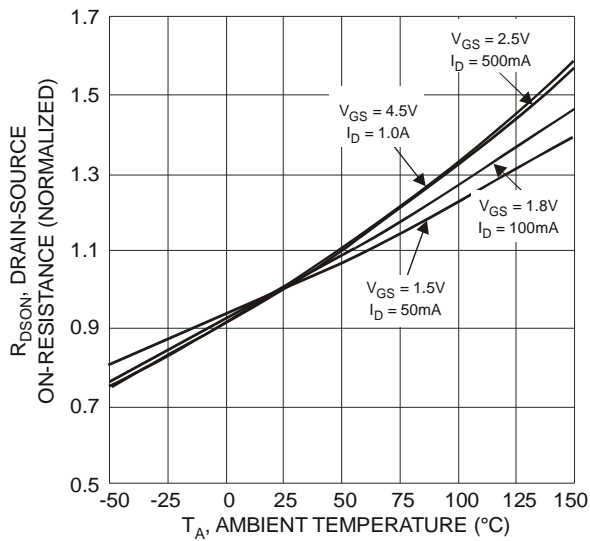

Fig. 10 On-Resistance Variation with Temperature

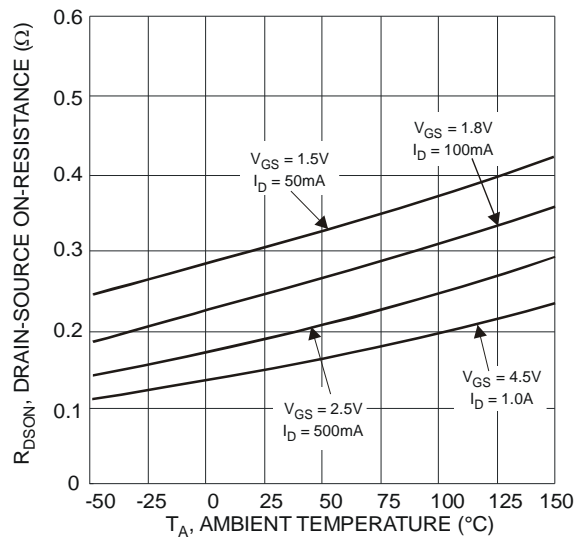

Fig. 11 On-Resistance Variation with Temperature

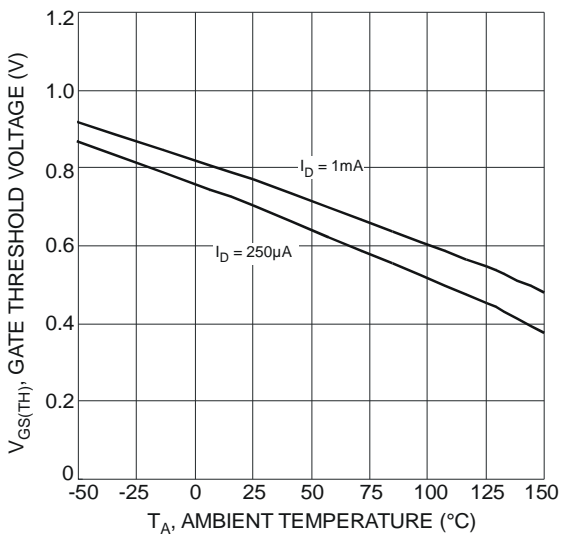

Fig. 12 Gate Threshold Variation vs. Ambient Temperature

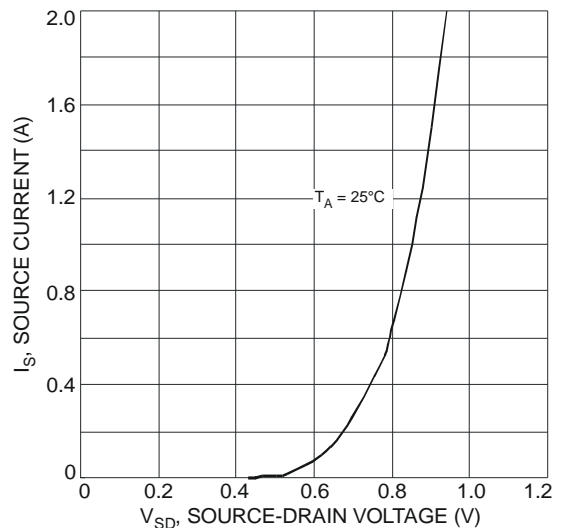

Fig. 13 Diode Forward Voltage vs. Current

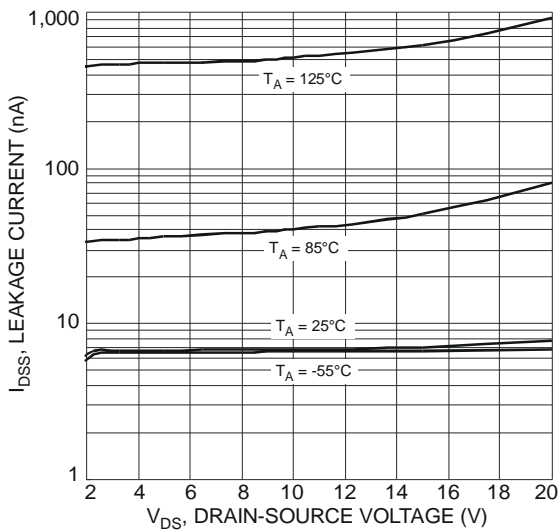

Fig. 14 Typical Leakage Current vs. Drain-Source Voltage

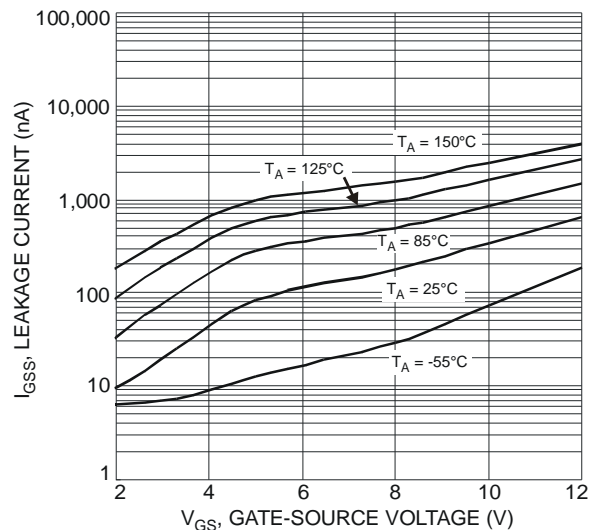

Fig. 15 Leakage Current vs. Gate-Source Voltage

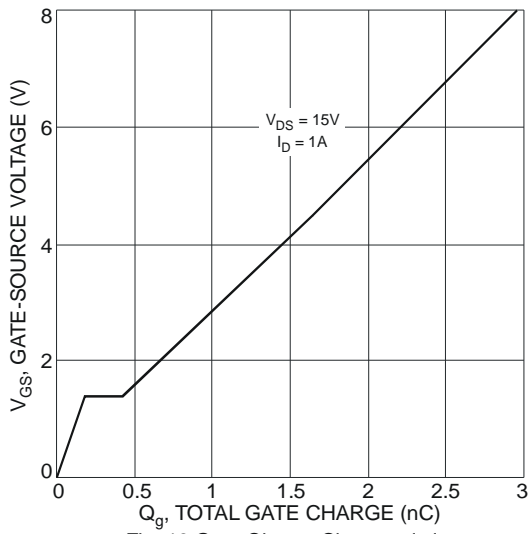
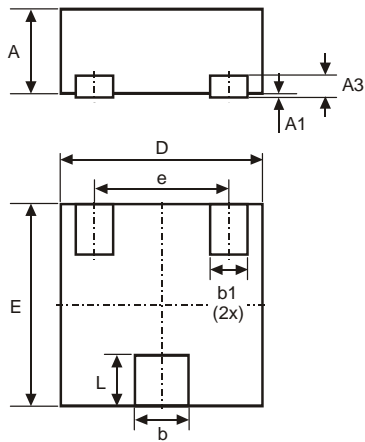

Fig. 16 Gate-Charge Characteristics

Package Outline Dimensions



X1-DFN1212-3			
Dim	Min	Max	Typ
A	0.47	0.53	0.50
A1	0	0.05	0.02
A3	-	-	0.13
b	0.27	0.37	0.32
b1	0.17	0.27	0.22
D	1.15	1.25	1.20
E	1.15	1.25	1.20
e	-	-	0.80
L	0.25	0.35	0.30

All Dimensions in mm

Suggested Pad Layout

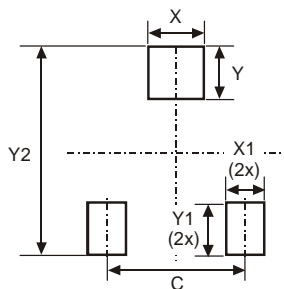

Dimensions	Value (in mm)
C	0.80
X	0.42
X1	0.32
Y	0.50
Y1	0.50
Y2	1.50

**A Product Line of
Diodes Incorporated****DMN2300UFD****IMPORTANT NOTICE**

DIODES INCORPORATED MAKES NO WARRANTY OF ANY KIND, EXPRESS OR IMPLIED, WITH REGARDS TO THIS DOCUMENT, INCLUDING, BUT NOT LIMITED TO, THE IMPLIED WARRANTIES OF MERCHANTABILITY AND FITNESS FOR A PARTICULAR PURPOSE (AND THEIR EQUIVALENTS UNDER THE LAWS OF ANY JURISDICTION).

Diodes Incorporated and its subsidiaries reserve the right to make modifications, enhancements, improvements, corrections or other changes without further notice to this document and any product described herein. Diodes Incorporated does not assume any liability arising out of the application or use of this document or any product described herein; neither does Diodes Incorporated convey any license under its patent or trademark rights, nor the rights of others. Any Customer or user of this document or products described herein in such applications shall assume all risks of such use and will agree to hold Diodes Incorporated and all the companies whose products are represented on Diodes Incorporated website, harmless against all damages.

Diodes Incorporated does not warrant or accept any liability whatsoever in respect of any products purchased through unauthorized sales channel. Should Customers purchase or use Diodes Incorporated products for any unintended or unauthorized application, Customers shall indemnify and hold Diodes Incorporated and its representatives harmless against all claims, damages, expenses, and attorney fees arising out of, directly or indirectly, any claim of personal injury or death associated with such unintended or unauthorized application.

Products described herein may be covered by one or more United States, international or foreign patents pending. Product names and markings noted herein may also be covered by one or more United States, international or foreign trademarks.

LIFE SUPPORT

Diodes Incorporated products are specifically not authorized for use as critical components in life support devices or systems without the express written approval of the Chief Executive Officer of Diodes Incorporated. As used herein:

A. Life support devices or systems are devices or systems which:

1. are intended to implant into the body, or
2. support or sustain life and whose failure to perform when properly used in accordance with instructions for use provided in the labeling can be reasonably expected to result in significant injury to the user.

B. A critical component is any component in a life support device or system whose failure to perform can be reasonably expected to cause the failure of the life support device or to affect its safety or effectiveness.

Customers represent that they have all necessary expertise in the safety and regulatory ramifications of their life support devices or systems, and acknowledge and agree that they are solely responsible for all legal, regulatory and safety-related requirements concerning their products and any use of Diodes Incorporated products in such safety-critical, life support devices or systems, notwithstanding any devices- or systems-related information or support that may be provided by Diodes Incorporated. Further, Customers must fully indemnify Diodes Incorporated and its representatives against any damages arising out of the use of Diodes Incorporated products in such safety-critical, life support devices or systems.

Copyright © 2011, Diodes Incorporated

www.diodes.com