

Excellent Integrated System Limited

Stocking Distributor

Click to view price, real time Inventory, Delivery & Lifecycle Information:

[Teledyne LeCroy](#)

[PP006A](#)

For any questions, you can email us directly:

sales@integrated-circuit.com

Probe PP006A

The PP006A is a high impedance passive probe with a wide range of probing accessories. It is designed to give high impedance probing capability to a circuit when attached to a LeCroy Oscilloscope.

System BW (−3dB)	: 500 MHz
System Attenuation	: $10 \times \pm 2\%$
System Input Resistance	: $10\text{ M} (\Omega) // 12\text{ pF}$
Compensation Range	: 13 pF to 23 pF
Cable Length	: 1.2 meters, Connector type BNC
Max. non-destructive input voltage	: 600 V (DC + Peak AC) (see derating curve)
Probe Sense	: Yes

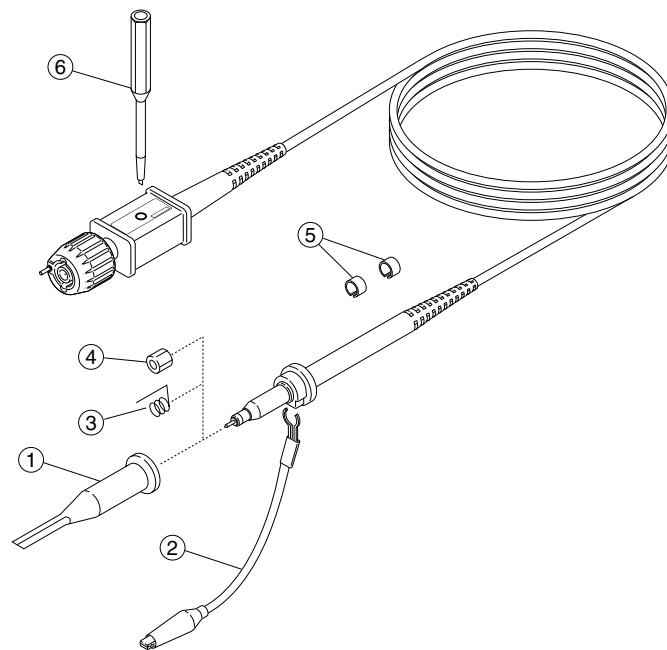

Accessories Table

Item	PP006A	PK116 accessory package
① Sprung hook	1	1
② Ground lead (11 cm)	1	1
③ Ground lead on probe tip	1	1
④ IC Insulating tip	1	1
⑤ Color marking band (yellow, red, blue, green)	4 × 2	4 × 2
⑥ Trimmer tool	1	1

Probe Adjustment

LF Adjustment

LF compensation is made by connecting the probe to the cal signal and adjusting the compensation trimmer in the BNC-box at end of the probe. Connect the BNC end of the probe to a channel of the oscilloscope. Connect the sprung hook end (1) and the ground lead (2) to the CAL out and GND on the scope Calibrator area. The CAL signal is available in many speeds. Select the Utilities in the scope to set the CAL to 1 kHz. Turn the scope channel on. Press Auto Setup and adjust the time base and volts/div settings until the signal on the screen contains two cycles (see figures below). Use the Trimmer tool (6) to adjust the probe response to match the correct trim shown below.

[Note] Do not apply excess pressure to the screwdriver when you use it. The tip of screwdriver are is easy to brake, because of made by plastics.

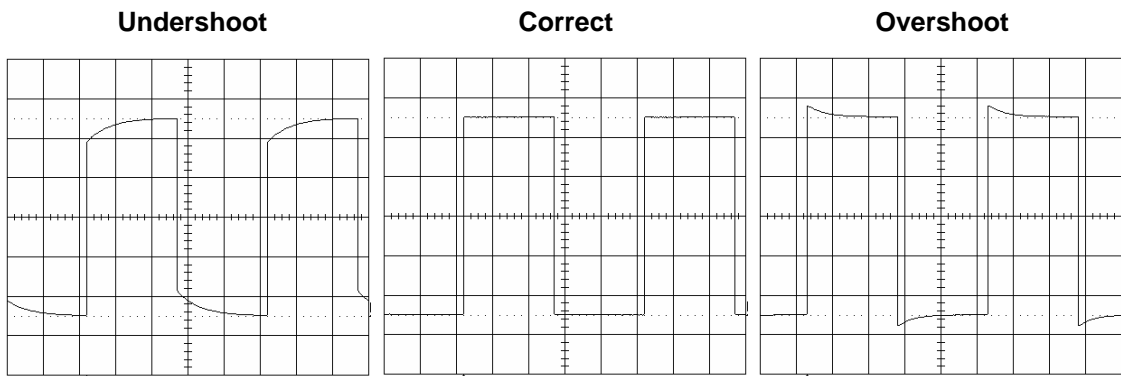

Typical Voltage Derating Curve

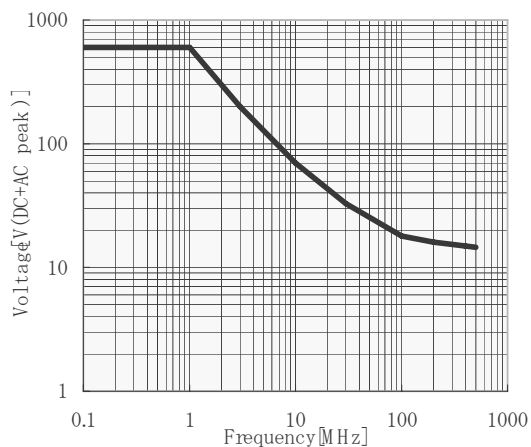

Typical Input Impedance

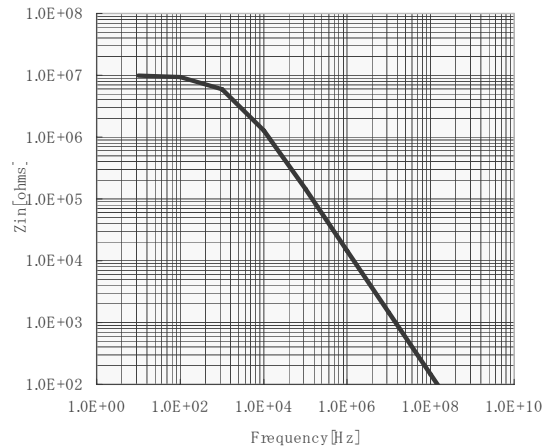

Installation for Safe and Efficient Operation

Operating Environment



Before using the Probe, ensure that its operating environment will be maintained within these parameters :

- Operation : In-door Use
- Temperature : 5 to 40 °C or 41 to 104 °F
- Humidity : < 80 % RH (non-condensing)

The Probe has been designed to comply with EN61010-1 Installation (Overvoltage) Category II, 600 V, Pollution Degree 2.



Safety Symbols

Wherever the following safety symbols appear on the Probe or in the instruction manual, they alert the user to an aspect of safety.

Symbol	Meaning
	Refer to accompanying documents (for Safety-related information).
	Risk of electric shock.
CAUTION	Calls attention to a procedure, practice or condition that could possibly cause damage to equipment.
WARNING	Calls attention to a procedure, practice or condition that could possibly cause bodily injury or death.

Usage

The probe is intended to be used only with instruments which are connected to earth ground through the input BNC connector. Connect the grounding terminal of the probe to the ground potential of a device to be measured.

-  **WARNING** Do not disconnect the probe while it is connected to a voltage source. Do not directly touch a measuring point. Do not use the probe in wet or explosive atmospheres.
-  **WARNING** Probe tips are sharp, misuse can result in injury. Use with care. The use of the probe and/or the instrument it is connected to in a manner other than specified may impair the safety mechanisms.
-  **CAUTION** To guarantee accurate performance characteristics, mechanical shocks should be avoided, as well as damage to the cable through excessive bending. Do not exceed the maximum specified signal voltage levels (See Specifications).

Cleaning and Maintenance

The exterior of the probe and cable should only be cleaned using a soft cloth moistened with water or isopropyl alcohol. The use of abrasive agents, strong detergents, or other solvents may damage the probe. Assure that the input receptacles are free of debris before inserting connection accessories.

All repair and maintenance should be referred to qualified service personnel. Do not use the probe if any part is damaged.

Sales & Service

LeCroy Corporation Headquarters 700 Chestnut Ridge Road Chestnut Ridge, NY 10977-6499

Tel (800) 5 LECROY Fax (845) 578 5985
--

Copyright, January 1999. LeCroy is a registered trademark of LeCroy Corporation.
All rights reserved. Information in this publication supercedes all earlier versions.
Specifications subject to change without notice.