

Excellent Integrated System Limited

Stocking Distributor

Click to view price, real time Inventory, Delivery & Lifecycle Information:

[Molex Connector Corporation](#)
[1061240110](#)

For any questions, you can email us directly:

sales@integrated-circuit.com

ADAPTER P/N	COLOR	SPLIT SLEEVE MATERIAL
106124-1100	BLUE	ZIRCONIA - ZrO ₂
106124-0110	BEIGE	Ph. Bronze
106124-1150	GREEN	ZIRCONIA - ZrO ₂
106124-0100	BLUE	Ph. Bronze
106124-1110	BEIGE	ZIRCONIA - ZrO ₂
106124-1130	BLACK	ZIRCONIA - ZrO ₂

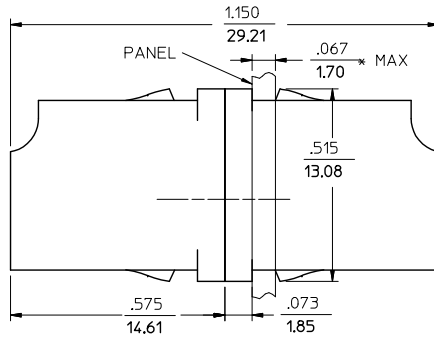
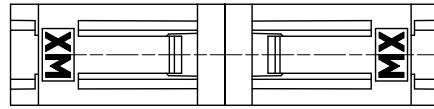

(DUST CAPS ARE NOT SHOWN)

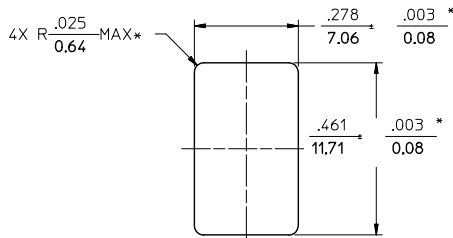
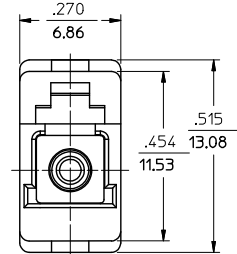

RECOMMENDED PANEL CUTOUT
 PANEL THICKNESS $\frac{.067}{1.70}$ MAX.

NOTES:
 1. ALL DIMENSIONS ARE FOR REFERENCE ONLY, EXCEPT WHEN MARKED WITH (*).

ENTER DESCRIPTION E.C. NO: ME2013-0244 DRAWN/REVISED: 2012/10/29 CHKD: [blank] APPR: [blank]	QUALITY SYMBOLS ▽=0 ▽=0	GENERAL TOLERANCES (UNLESS SPECIFIED)		DIMENSION STYLE	SCALE	DESIGN UNITS	THIRD ANGLE PROJECTION	
			mm	INCH	IN/MM	1:1	INCH	
		4 PLACES	±	---	PGIBLIN	DATE	TITLE	
		3 PLACES	±	---	CHECKED BY	DATE	LC ADAPTER	
2 PLACES	±	---	APPROVED BY		DATE			
1 PLACE	±	---	MATERIAL NO.		DOCUMENT NO.			SHEET NO.
0 PLACE	±	---	ANGULAR ±1/2°		SEE TABLE	SD-106124-X1X0	1 OF 1	
DRAFT WHERE APPLICABLE MUST REMAIN WITHIN DIMENSIONS		SIZE	THIS DRAWING CONTAINS INFORMATION THAT IS PROPRIETARY TO MOLEX INCORPORATED AND SHOULD NOT BE USED WITHOUT WRITTEN PERMISSION					