

## Excellent Integrated System Limited

Stocking Distributor

Click to view price, real time Inventory, Delivery & Lifecycle Information:

[Molex Connector Corporation](#)  
[5011905027](#)

For any questions, you can email us directly:

[sales@integrated-circuit.com](mailto:sales@integrated-circuit.com)

10 9 8 7 6 5 4 3 2 1

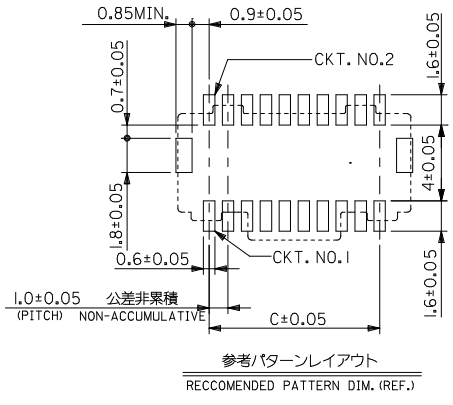
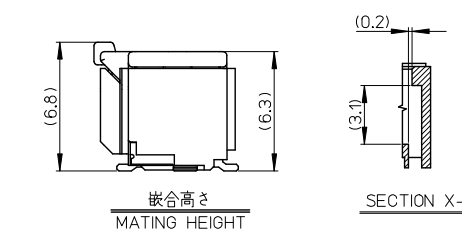
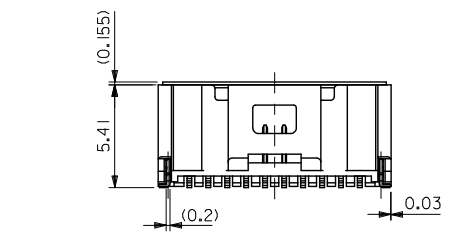
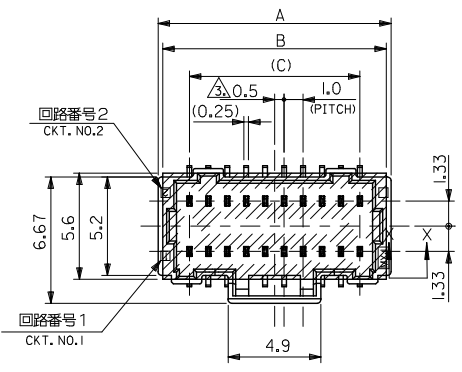

参考/パターンレイアウト  
RECOMMENDED PATTERN DIM. (REF.)

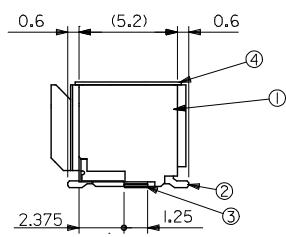

番号 PART NO.	部品 PART	材質 MATERIAL
①	ウエハー WAFER	耐熱ナイロン, UL94V-0, 色: シート2参照 HEAT RESISTANCE NYLON, UL94V-0, COLOR: SEE SHEET 2
②	ソルダーピン SOLDER PIN	りん青銅 PHOSPHOR BRONZE 金メッキ: 0.1µmMIN. GOLD ニッケルメッキ (下地): 1.0µmMIN. NICKEL(UNDER PLATING)
③	ネイル NAIL	りん青銅 PHOSPHOR BRONZE 鍍メッキ: 1.0µmMIN. TIN ニッケルメッキ (下地): 1.0µmMIN. NICKEL(UNDER PLATING)
④	カバーテープ COVER TAPE	ポリイミドテープ POLYIMIDE TAPE

- NOTES.
- 嵌合相手: 501189-\*\*\*\*  
MATE WITH: 501189-\*\*\*\*
  - ソルダーピン及びネイル平坦度は、0.1MAX.  
SOLDER PIN AND NAIL COPLANARITY TO BE 0.1MAX.
  - 極数/2=偶数に適用  
APPLY FOR CKT SIZE/2=EVEN
  - ELV 及び RoHS 適合品  
ELV AND RoHS COMPLIANT.

無 NO	24	27.3	22.3	501190-5027	501190-5029	50		
				19	17.3	501190-4027	501190-4029	40
有 YES	14	12.3	501190-3027	501190-3029	30			
	9	12.3	501190-2027	501190-2029	20			
	24	26.8	27.3	501190-5017	501190-5019	50		
	19	21.8	22.3	501190-4017	501190-4019	40		
カバーテープの有無 COVER TAPE	C	B	A	EMBOSSED PACKAGE	CONNECTOR	CKT		
				オーダー番号	ORDER NO.	SERIES NO.		
				SCALE 5:1			DESIGN UNITS METRIC	THIRD ANGLE PROJECTION
				TITLE			1.0 WIRE TO BOARD CONN. WAFER ASS'Y (2-ROW S/T) -LEAD FREE-	

REVISED EC NO. J2014-1175 DRAWN BY CHIKIDAKAWA APPROVED BY AKIYUKIYAMA 2013/11/25 2013/11/25 2014/01/28	GENERAL TOLERANCES (UNLESS SPECIFIED)		DIMENSION STYLE MM ONLY		SCALE 5:1		DESIGN UNITS METRIC		THIRD ANGLE PROJECTION	
	10 UNDER	±0.2	DRAWN BY	DATE	TITLE					
	10 OVER 30 UNDER	±0.25	NYOSHIDA	2004/12/17	1.0 WIRE TO BOARD CONN. WAFER ASS'Y (2-ROW S/T) -LEAD FREE-					
	30 OVER	±0.3	CHECKED BY	DATE	molex					
ANGULAR ±3°		DRAFT WHERE APPLICABLE MUST REMAIN WITHIN DIMENSIONS		APPROVED BY	DATE	MATERIAL NO.		DOCUMENT NO.		SHEET NO.
				ANODA	2004/12/17	SEE CHART		SD-501190-003		1 OF 2
				THIS DRAWING CONTAINS INFORMATION THAT IS PROPRIETARY TO MOLEX INCORPORATED AND SHOULD NOT BE USED WITHOUT WRITTEN PERMISSION						

9 8 7 6 5 4 3 2 1

10 9 8 7 6 5 4 3 2 1

有 YES	緑 GREEN	青 BLUE	赤 RED	黒 BLACK	色 COLOR	
	---	---	---	---	---	50
501190-4056	501190-4054	501190-4052	501190-4051	40		
501190-3056	501190-3054	501190-3052	501190-3051	30		
501190-2056	501190-2054	501190-2052	501190-2051	20		
COVER TAPE	EMBOSSED PACKAGE オーダー番号 ORDER NO.				CKT.	CONNECTOR SERIES NO.
無 NO	自然色 NATURAL		色 COLOR			
	501190-5027	50	501190-**29			
	501190-4027	40				
	501190-3027	30				
501190-2027	20					
COVER TAPE	EMBOSSED PACKAGE オーダー番号 ORDER NO.				CKT.	CONNECTOR SERIES NO.
有 YES	自然色 NATURAL		色 COLOR			
	501190-5017	50	501190-**19			
	501190-4017	40				
	501190-3017	30				
501190-2017	20					
COVER TAPE	EMBOSSED PACKAGE オーダー番号 ORDER NO.				CKT.	CONNECTOR SERIES NO.

SEE SHEET 1 EC NO. J2014-1175 DRAWN BY CHIKIDAKAWA APPR. NIKITA 2013/11/22 2013/11/25 2014/01/28	GENERAL TOLERANCES (UNLESS SPECIFIED)		DIMENSION STYLE MM ONLY		SCALE 5:1	DESIGN UNITS METRIC	THIRD ANGLE PROJECTION
	10 UNDER	± 0.2	DRAWN BY NYOSHIDA	DATE 2004/12/17	TITLE 1.0 WIRE TO BOARD CONN. WAFER ASS'Y (2-ROW S/T) -LEAD FREE- 		
	10 OVER 30 UNDER	± 0.25	CHECKED BY MYAGI	DATE 2004/12/17			
	30 OVER	± 0.3	APPROVED BY ANODA	DATE 2004/12/17			
	ANGULAR ±3 °		MATERIAL NO.				
DRAFT WHERE APPLICABLE MUST REMAIN WITHIN DIMENSIONS		SEE CHART					
		SIZE A3	THIS DRAWING CONTAINS INFORMATION THAT IS PROPRIETARY TO MOLEX INCORPORATED AND SHOULD NOT BE USED WITHOUT WRITTEN PERMISSION		DOCUMENT NO. SD-501190-003	SHEET NO. 2 OF 2	

9 8 7 6 5 4 3 2 1

10 9 8 7 6 5 4 3 2 1

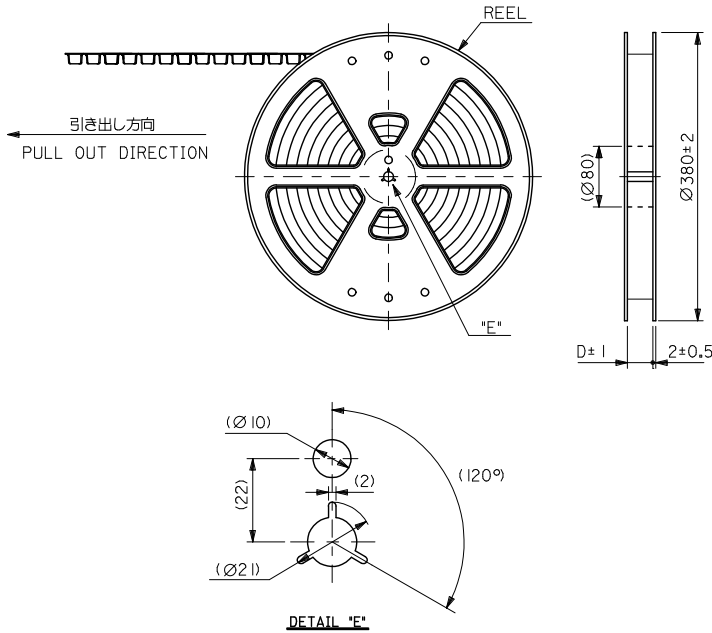

**NOTES**

1. 製品詳細寸法については SD-501190-003 を参照ください。  
RE DETAILED DIMENSION, SEE SD-501190-003

2. 梱包数量：1100個/リール  
NUMBER OF CONNECTORS：1100PIECES/REEL

3. リードテープ長さ  
LEAD TAPE LENGTH

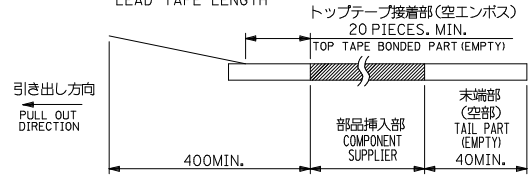

4. トップテープの剥離強度：0.1~1.3N(10.2~132.5gf) (剥離方向は下図参照)  
PEELING OFF FORCE OF TOP TAPE (PEELING DIRECTION AS SHOWN IN FOLLOWING FIGURE)

尚、本規格値は、出荷時に適用。(但し、輸送時に剥離が発生しないこと)  
THIS REQUIREMENT SHOULD BE APPLIED AT SHIPMENT.  
PEEL OFF SHOULD NOT BE ALLOWED, DURING TRANSPORTATION.

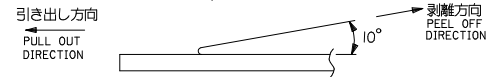

5. 材料  
MATERIAL  
キャリアテープ：ポリプロピレン  
CARRIER TAPE: POLYPROPYLENE  
トップテープ：PET, PE, REF  
TOP TAPE  
リール：ポリスチレン (リサイクル材を含む)  
REEL: POLYSTYRENE (RECYCLE MATERIAL CONTAINED)

6. 乾燥剤入り防湿梱包仕様になります。(501190-\*\*17, 501190-\*\*27以外)  
INCLUDING DESICCANT TAPING PACKAGE.  
(BESIDES 501190-\*\*17, 501190-\*\*27)

7. ELV 及び RoHS 適合品  
ELV AND RoHS COMPLIANT.

REVISED EC NO: J2013-1460 DRAWN BY: DRINKAWASHIO 2013/06/12 CHECKED BY: CHIKIDAKAKAWA 2013/06/12 APPROVED BY: APRRUKIKITA 2013/06/12	GENERAL TOLERANCES (UNLESS SPECIFIED)		DIMENSION STYLE MM ONLY		SCALE ---	DESIGN UNITS METRIC	THIRD ANGLE PROJECTION
	10 UNDER	± 0.2	DRAWN BY NYOSHIDA	DATE 2004/12/17	TITLE 1.0 WIRE TO BOARD CONN. WAFER ASS'Y (2-ROW S/T) EMBTP PKG -LEAD FREE-		
	10 OVER 30 UNDER	± 0.25	CHECKED BY MYAGI	DATE 2004/12/17			
	30 OVER	± 0.3	APPROVED BY ANODA	DATE 2004/12/17	DOCUMENT NO. SD-501190-004		
ANGULAR ±3 °		MATERIAL NO. SEE SHEET 2		SHEET NO. 1 OF 3			
DRAFT WHERE APPLICABLE MUST REMAIN WITHIN DIMENSIONS		THIS DRAWING CONTAINS INFORMATION THAT IS PROPRIETARY TO MOLEX INCORPORATED AND SHOULD NOT BE USED WITHOUT WRITTEN PERMISSION					

9 8 7 6 5 4 3 2

10 9 8 7 6 5 4 3 2 1

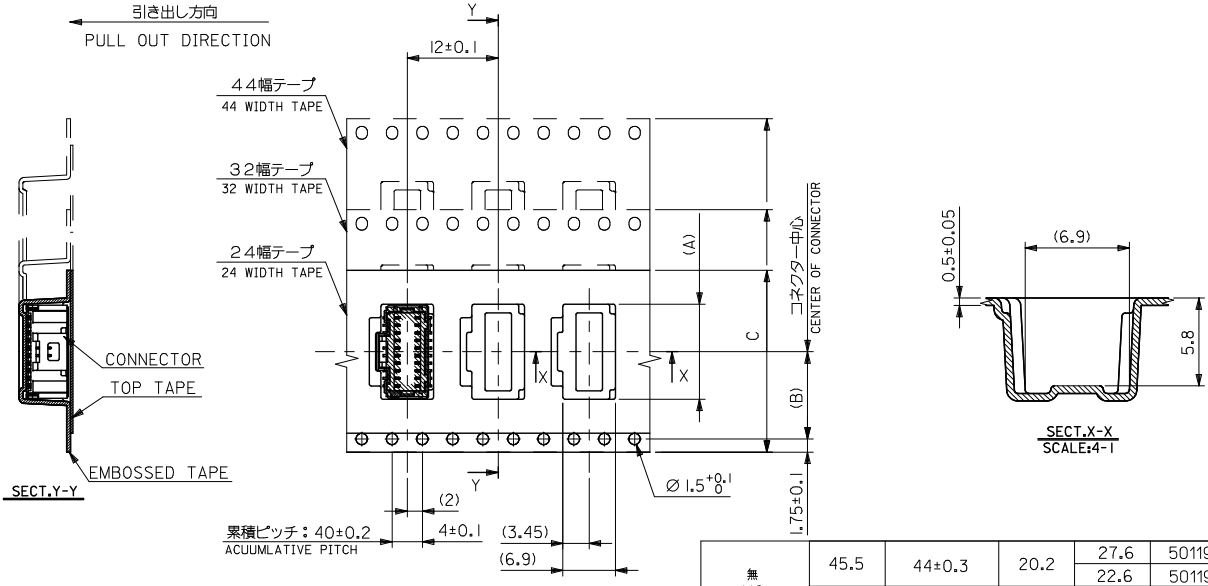

無 NO	45.5	44±0.3	20.2	27.6	501190-5029	501190-5027	50
				22.6	501190-4029	501190-4027	40
	33.5	32±0.3	14.2	17.6	501190-3029	501190-3027	30
	25.5	24±0.3	11.5	12.6	501190-2029	501190-2027	20
有 YES				27.6	501190-5019	501190-5017	50
	45.5	44±0.3	20.2	22.6	501190-4019	501190-4017	40
					501190-407*	501190-405*	
	33.5	32±0.3	14.2	17.6	501190-3019	501190-3017	30
					501190-307*	501190-305*	
	25.5	24±0.3	11.5	12.6	501190-2019	501190-2017	20
				501190-207*	501190-205*		
※兼用カバーテープの有無 COVER TAPE	D	C	(B)	(A)	CONNECTOR SERIES NO.	EMBOSSED PACKAGE オーダー番号 ORDER NO.	CKTS.

REVISED DEC NO: J2013-1460 DRAWN BY: 2013/06/12 CHKD BY: CHIKIDAKAWA APPR: NIKITA 2013/06/12	DESCRIPTION	GENERAL TOLERANCES (UNLESS SPECIFIED)		DIMENSION STYLE		SCALE	DESIGN UNITS	THIRD ANGLE PROJECTION		
				MM ONLY		---	METRIC	◎ □		
		10 UNDER	± 0.2	DRAWN BY	DATE	TITLE				
		10 OVER 30 UNDER	± 0.25	NYOSHIDA	2004/12/17	1.0 WIRE TO BOARD CONN. WAFER ASS'Y (2-ROW S/T) EMBTB PKG -LEAD FREE-				
30 OVER	± 0.3	CHECKED BY	DATE							
ANGULAR ± 3 °		MYAGI	2004/12/17							
DRAFT WHERE APPLICABLE MUST REMAIN WITHIN DIMENSIONS		APPROVED BY	DATE	MATERIAL NO.	DOCUMENT NO.	SHEET NO.				
		ANODA	2004/12/17	SEE CHART	SD-501190-004	2 OF 3				
		THIS DRAWING CONTAINS INFORMATION THAT IS PROPRIETARY TO MOLEX INCORPORATED AND SHOULD NOT BE USED WITHOUT WRITTEN PERMISSION								

9 8 7 6 5 4 3 2 1

10 9 8 7 6 5 4 3 2 1

有 YES	緑 GREEN	青 BLUE	赤 RED	黒 BLACK	色 COLOR	
	---	---	---	---	---	50
501190-4056	501190-4054	501190-4052	501190-4051	40		
501190-3056	501190-3054	501190-3052	501190-3051	30		
501190-2056	501190-2054	501190-2052	501190-2051	20		
COVER TAPE	EMBOSSED PACKAGE オーダー番号 ORDER NO.				CKT.	CONNECTOR SERIES NO.
無 NO	自然色 NATURAL		色 COLOR			
	501190-5027	50	501190-**29			
	501190-4027	40				
	501190-3027	30				
501190-2027	20	COVER TAPE				
有 YES	自然色 NATURAL		色 COLOR			
	501190-5017	50	501190-**19			
	501190-4017	40				
	501190-3017	30				
501190-2017	20	COVER TAPE				
EMBOSSED PACKAGE オーダー番号 ORDER NO.					CKT.	CONNECTOR SERIES NO.

SEE SHEET 1 EC NO. J2013-1460 DRAWN BY DRUMKASHIO 2013/06/12 CHECKED BY CHIKIDAKAKAWA 2013/06/12 APPROVED BY APPR.NIKITA 2013/06/12 REV D	GENERAL TOLERANCES (UNLESS SPECIFIED)		DIMENSION STYLE MM ONLY		SCALE ---	DESIGN UNITS METRIC	THIRD ANGLE PROJECTION
	10 UNDER	± 0.2	DRAWN BY NYOSHIDA	DATE 2004/12/17	TITLE 1.0 WIRE TO BOARD CONN. WAFER ASS'Y (2-ROW S/T) EMBTP PKG -LEAD FREE-		
	10 OVER 30 UNDER	± 0.25	CHECKED BY MYAGI	DATE 2004/12/17			
	30 OVER	± 0.3	APPROVED BY ANODA	DATE 2004/12/17			
ANGULAR ±3 °		MATERIAL NO.		DOCUMENT NO.		SHEET NO.	
DRAFT WHERE APPLICABLE MUST REMAIN WITHIN DIMENSIONS		SEE CHART		SD-501190-004		3 OF 3	
SIZE A3 THIS DRAWING CONTAINS INFORMATION THAT IS PROPRIETARY TO MOLEX INCORPORATED AND SHOULD NOT BE USED WITHOUT WRITTEN PERMISSION							

9 8 7 6 5 4 3 2 1