



Distributor of Molex Connector Corporation: Excellent Integrated System Limited
Datasheet of 5023860572 - Connector Receptacle 5 Position 0.049" (1.25mm) Tin Surface
Mount, Right Angle

Contact us: sales@integrated-circuit.com Website: www.integrated-circuit.com

Excellent Integrated System Limited

Stocking Distributor

Click to view price, real time Inventory, Delivery & Lifecycle Information:

[Molex Connector Corporation](#)
[5023860572](#)

For any questions, you can email us directly:
sales@integrated-circuit.com

Contact us: sales@integrated-circuit.com Website: www.integrated-circuit.com

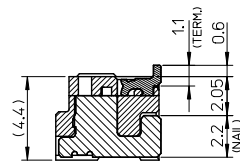
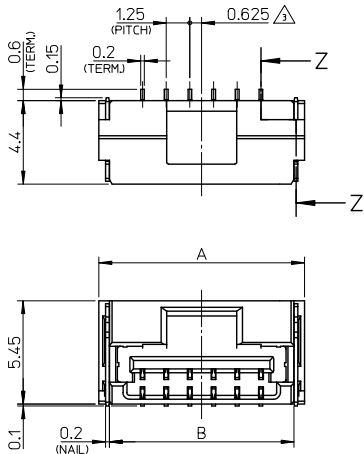

SECTION Z-Z

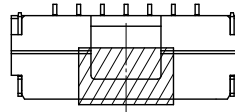

カプトンテープ付き
WITH KAPTON TAPE

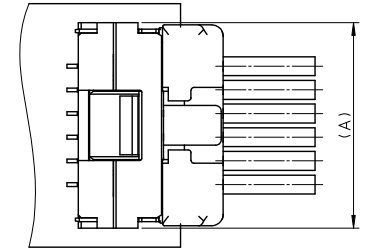

嵌合図
MATED CONNECTORS

NOTES

- 嵌合相手: 502380-****
MATE WITH: 502380-****
- 端子テール部 及び ネイルの平坦度: 0.1MAX,
TAIL AND NAIL COPLANARITY TO BE 0.1 MAX.
- 極数/2=偶数に適用。
APPLY FOR CKT. SIZE / 2 = EVEN.
- 端子テール部 及び ネイルに錫めっきを使用しているため、
外観に摺動痕が付く場合がございます。
THE WOUND OF FRICTION MIGHT ADHERE TO EXTERNALS
BECAUSE THE TIN PLATING IS USED FOR THA TAIL AND NAIL.
- 本製品のプラスチック部に黒点等が確認される場合や
色合いが異なる場合がありますが、製品性能に影響はありません。
THERE IS NO INFLUENCE IN THE PRODUCT PERFORMANCE THOUGH
THE BLACK SPOT ETC. MIGHT BE CONFIRMED TO THE PLASTIC PART
OF THIS PRODUCT AND THE SHADE MIGHT BE DIFFERENT.
- ELV 及び RoHS 適合品
ELV AND RoHS COMPLIANT

3.4	7.5	11	12.1	502386-07**	7
3.4	6.25	9.75	10.85	502386-06**	6
3.4	5	8.5	9.6	502386-05**	5
3.4	3.75	7.25	8.35	502386-04**	4
2.6	2.5	6	7.1	502386-03**	3
2.2	1.25	4.75	5.85	502386-02**	2

番号 NO.	部品 PART	材質 MATERIAL
①	ハウジング HOUSING	耐熱性樹脂 UL94V-0 色: SHEET 3 参照 HEATPROOF RESIN UL94V-0 COLOR: SEE SHEET 3
②	ターミナル TERMINAL	銅合金 COPPER ALLOY 錫めっき: 1.0 micro-meter MIN. TIN (TAIL AREA) ニッケルめっき(下地): 1.0 micro-meter MIN. NICKEL (UNDER PLATING)
③	ネイル NAIL	銅合金 COPPER ALLOY 錫めっき: 1.0 micro-meter MIN. TIN ニッケルめっき(下地): 1.0 micro-meter MIN. NICKEL (UNDER PLATING)

REVISED DEC. NO. J2013-0870 T. MIYAZAKI 2013/02/07 CHIKIDAKAKAWA 2013/02/13 APPR: Y. ITO 2013/02/13	GENERAL TOLERANCES (UNLESS SPECIFIED)		DIMENSION STYLE MM ONLY		SCALE 5:1	DESIGN UNITS METRIC	THIRD ANGLE PROJECTION
	10 UNDER	± 0.2	DRAWN BY T. MIYAZAKI	DATE 2006/08/28	TITLE 1.25 W/B CONN. SINGLE R/A REC. ASS'Y 2-7CKT. molex DOCUMENT NO. SD-502386-001 SHEET NO. 1 OF 3		
	10 OVER 30 UNDER	± 0.25	CHECKED BY K. ASAKAWA	DATE 2006/08/28			
	30 OVER	± 0.3	APPROVED BY Y. ITO	DATE 2006/08/28			
ANGULAR ± 3 °		MATERIAL NO.					
DRAFT WHERE APPLICABLE MUST REMAIN WITHIN DIMENSIONS		SEE TABLE		THIS DRAWING CONTAINS INFORMATION THAT IS PROPRIETARY TO MOLEX INCORPORATED AND SHOULD NOT BE USED WITHOUT WRITTEN PERMISSION			

Contact us: sales@integrated-circuit.com Website: www.integrated-circuit.com



2 CKT.

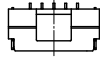

5 CKT.



3 CKT.

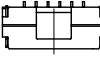

6 CKT.



4 CKT.

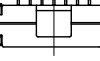

7 CKT.

極数の種類
KIND OF CKT. NO.(FRONT VIEW)

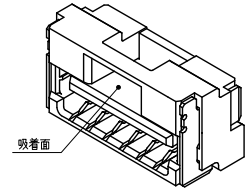
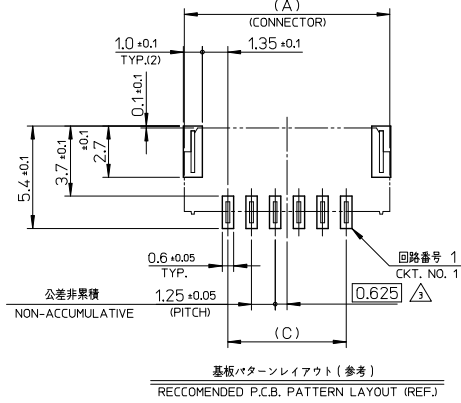
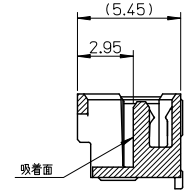
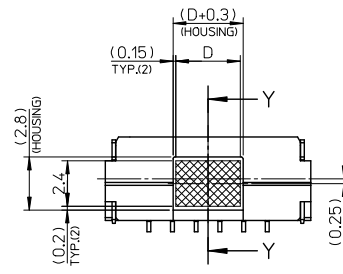

REVISED EC NO. J2013-0870 DRAWN BY T. DRUNKASHIO 2013/02/07 CHECKED BY CHIKIDAKAKAWA 2013/02/13 APPROVED BY Y. ITO 2013/02/13	GENERAL TOLERANCES (UNLESS SPECIFIED)		DIMENSION STYLE MM ONLY	SCALE 5:1	DESIGN UNITS METRIC	THIRD ANGLE PROJECTION
	10 UNDER	± 0.2	DRAWN BY DATE T. MIYAZAKI 2006/08/28	TITLE 1.25 W/B CONN. SINGLE R/A REC. ASS'Y 2-7CKT.		
	10 OVER 30 UNDER	± 0.25	CHECKED BY DATE K. ASAKAWA 2006/08/28			
	30 OVER	± 0.3	APPROVED BY DATE Y. ITO 2006/08/28			
ANGULAR	± 3 °	MATERIAL NO.	SEE TABLE	DOCUMENT NO. SD-502386-001	SHEET NO. 2 OF 3	
DRAFT WHERE APPLICABLE MUST REMAIN WITHIN DIMENSIONS		THIS DRAWING CONTAINS INFORMATION THAT IS PROPRIETARY TO MOLEX INCORPORATED AND SHOULD NOT BE USED WITHOUT WRITTEN PERMISSION				

Contact us: sales@integrated-circuit.com Website: www.integrated-circuit.com

WITH CAPTON TAPE										
HSG COLOR : GREEN		HSG COLOR : BLUE		HSG COLOR : RED		HSG COLOR : BLACK		HSG COLOR : NATURAL		
502386-0736	502386-***16	502386-0734	502386-***14	502386-0732	502386-***12	502386-0731	502386-***11	502386-0772	502386-***08	
502386-0636		502386-0634		502386-0632		502386-0631		502386-0672		
502386-0536		502386-0534		502386-0532		502386-0531		502386-0572		
502386-0436		502386-0434		502386-0432		502386-0431		502386-0472		
502386-0336		502386-0334		502386-0332		502386-0331		502386-0372		
502386-0236		502386-0234		502386-0232		502386-0231		502386-0272		
EMBOSSED TAPE PACKAGE オーダー番号ORDER No.	コネクタ シリЭС CONNECTOR SERIES	EMBOSSED TAPE PACKAGE オーダー番号ORDER No.	コネクタ シリЭС CONNECTOR SERIES	EMBOSSED TAPE PACKAGE オーダー番号ORDER No.	コネクタ シリЭС CONNECTOR SERIES	EMBOSSED TAPE PACKAGE オーダー番号ORDER No.	コネクタ シリЭС CONNECTOR SERIES	EMBOSSED TAPE PACKAGE オーダー番号ORDER No.	コネクタ シリЭС CONNECTOR SERIES	極数 (EXT. NO.)

WITHOUT CAPTON TAPE										
HSG COLOR : GREEN		HSG COLOR : BLUE		HSG COLOR : RED		HSG COLOR : BLACK		HSG COLOR : NATURAL		
502386-0746	502386-***26	502386-0744	502386-***24	502386-0742	502386-***22	502386-0741	502386-***21	502386-0770	502386-***09	
502386-0646		502386-0644		502386-0642		502386-0641		502386-0670		
502386-0546		502386-0544		502386-0542		502386-0541		502386-0570		
502386-0446		502386-0444		502386-0442		502386-0441		502386-0470		
502386-0346		502386-0344		502386-0342		502386-0341		502386-0370		
502386-0246		502386-0244		502386-0242		502386-0241		502386-0270		
EMBOSSED TAPE PACKAGE オーダー番号ORDER No.	コネクタ シリЭС CONNECTOR SERIES	EMBOSSED TAPE PACKAGE オーダー番号ORDER No.	コネクタ シリЭС CONNECTOR SERIES	EMBOSSED TAPE PACKAGE オーダー番号ORDER No.	コネクタ シリЭС CONNECTOR SERIES	EMBOSSED TAPE PACKAGE オーダー番号ORDER No.	コネクタ シリЭС CONNECTOR SERIES	EMBOSSED TAPE PACKAGE オーダー番号ORDER No.	コネクタ シリЭС CONNECTOR SERIES	極数 (EXT. NO.)

REVISED EC NO. J2013-0870 T1 DRW: NAWASHIO CHIKIDAKAKAWA APPR: Y. ITO REV	2013/02/07	DESCRIPTION GENERAL TOLERANCES (UNLESS SPECIFIED) 10 UNDER ±0.2 10 OVER 30 UNDER ±0.25 30 OVER ±0.3 ANGULAR ±3 ° DRAFT WHERE APPLICABLE MUST REMAIN WITHIN DIMENSIONS	DIMENSION STYLE MM ONLY		SCALE ----	DESIGN UNITS METRIC	THIRD ANGLE PROJECTION	1.25 W/B CONN. SINGLE R/A REC. ASS'Y 2-7CKT. molex MATERIAL NO. SEE TABLE DOCUMENT NO. SD-502386-001 SHEET NO. 3 OF 3	
	2013/02/13		DRAWN BY DATE T. MIYAZAKI 2006/08/28	TITLE					
	2013/02/13		CHECKED BY DATE K. ASAKAWA 2006/08/28						
			APPROVED BY DATE Y. ITO 2006/08/28						

Contact us: sales@integrated-circuit.com Website: www.integrated-circuit.com

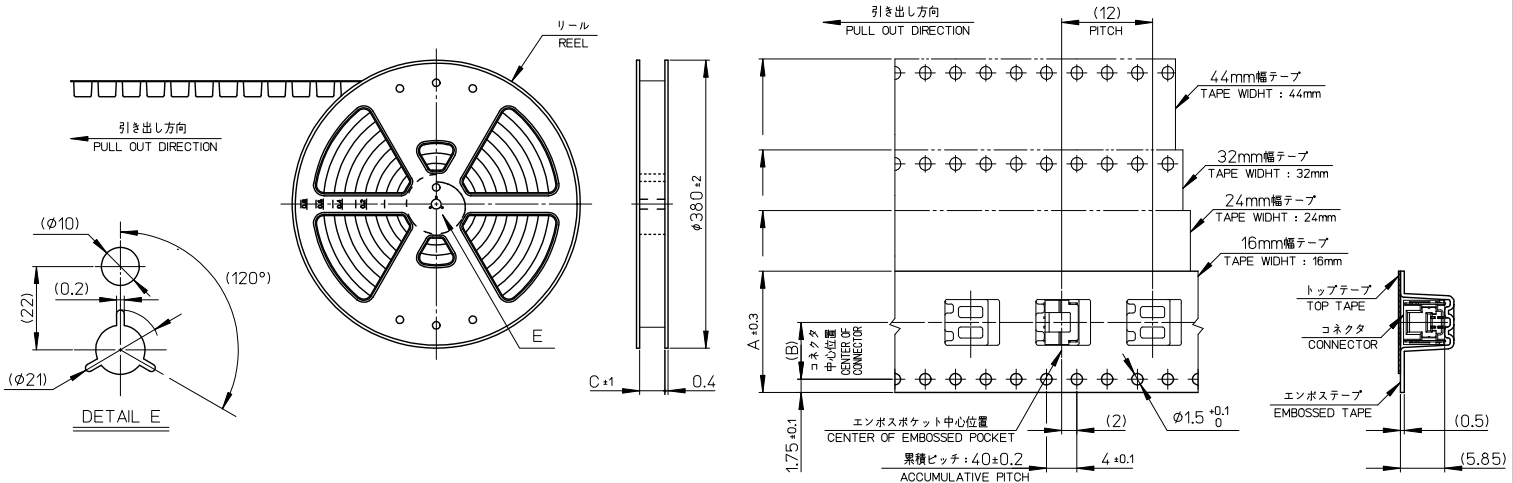

NOTES

- 製品詳細寸法については、SD-502386-001, -002 を参照下さい。
PLEASE REFER TO SD-502386-001, -002 FOR THE DETAILED DIMENSION OF THE CONNECTOR.
- 梱包数量 : 1200個
NUMBER OF CONNECTIONS : 1200 PIECES/REEL.
- リードテープ長さ
LEAD TAPE LENGTH

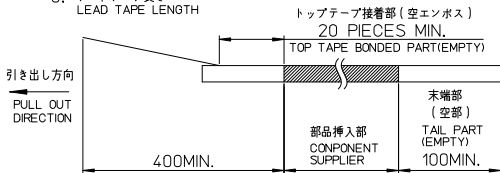

- 材料
MATERIAL
キャリアテープ : ポリスチレン
CARRIER TAPE : POLYSTYRENE
トップテープ : ポリエステル, ポリエチレン, ポリエチレンテレフタレート
TOP TAPE : POLYESTER, POLYETHYLENE, POLYETHYLENE TEREPHTHALATE
リール : ポリスチレン <リサイクル材を含む>
REEL : POLYSTYRENE <RECYCLE MATERIAL CONTAINED>
- ELV 及び RoHS 適合品
ELV AND ROHS COMPLIANT

エンボステープ幅 A WIDTH OF TAPE	エンボステープ幅 B WIDTH OF TAPE	エンボステープ幅 C WIDTH OF TAPE	製品番号 MATERIAL NO.	極数 (XT. NO.)
44.5	20.2	44	502386-15**	15
45.5	20.2	44	502386-14**	14
33.5	14.2	32	502386-13**	13
33.5	14.2	32	502386-12**	12
33.5	14.2	32	502386-11**	11
33.5	14.2	32	502386-10**	10
25.5	11.5	24	502386-09**	9
25.5	11.5	24	502386-08**	8
25.5	11.5	24	502386-07**	7
25.5	11.5	24	502386-06**	6
25.5	11.5	24	502386-05**	5
25.5	11.5	24	502386-04**	4
17.5	7.5	16	502386-03**	3
17.5	7.5	16	502386-02**	2

GENERAL TOLERANCES (UNLESS SPECIFIED)		DIMENSION STYLE		SCALE	DESIGN UNITS	THIRD ANGLE PROJECTION	
		MM ONLY		---	METRIC		
10 UNDER	± 0.2	DRAWN BY	DATE	TITLE			
10 OVER 30 UNDER	± 0.25	T. MIYAZAKI	2006/10/16	1.25 W/B CONN. SINGLE R/A REC. EMBTP PKG			
30 OVER	± 0.3	CHECKED BY	DATE				
ANGULAR	$\pm 3^\circ$	K. ASAKAWA	2006/10/16				
DRAFT WHERE APPLICABLE MUST REMAIN WITHIN DIMENSIONS		APPROVED BY	DATE				
		YO. ITO	2006/10/16				
		MATERIAL NO.	DOCUMENT NO.				
		SEE TABLE	SD-502386-003				
		THIS DRAWING CONTAINS INFORMATION THAT IS PROPRIETARY TO MOLEX INCORPORATED AND SHOULD NOT BE USED WITHOUT WRITTEN PERMISSION					

Contact us: sales@integrated-circuit.com Website: www.integrated-circuit.com

WITHOUT CAPTON TAPE			WITH CAPTON TAPE										
HSG COLOR : ORANGE			HSG COLOR : GREEN		HSG COLOR : BLUE		HSG COLOR : RED		HSG COLOR : BLACK		HSG COLOR : NATURAL		
502386-**28	---	15	---	---	---	---	---	---	---	---	---	---	
	---	14	---	---	---	---	---	---	---	---	---	---	
	---	13	---	---	---	---	---	---	---	---	---	---	
	---	12	---	---	---	---	---	---	---	---	---	---	
	---	11	---	---	---	---	---	---	---	---	---	---	
	---	10	---	---	---	---	---	---	---	---	---	---	
	502386-0948	9	---	---	---	---	---	---	---	---	---	---	
	---	8	---	---	---	---	---	---	---	---	---	---	
	---	7	---	---	---	---	---	---	---	---	---	---	
	---	6	---	---	---	---	---	---	---	---	---	---	
---	5	502386-0736	---	502386-0734	---	502386-0732	---	502386-0731	---	502386-0772	---	7	
---	4	502386-0636	---	502386-0634	---	502386-0632	---	502386-0631	---	502386-0672	---	6	
---	3	502386-0536	502386-**14	502386-0534	502386-**12	502386-0532	502386-**11	502386-0531	502386-**08	502386-0572	---	5	
---	2	502386-0436	---	502386-0434	---	502386-0432	---	502386-0431	---	502386-0472	---	4	
---	1	502386-0336	---	502386-0334	---	502386-0332	---	502386-0331	---	502386-0372	---	3	
---	0	502386-0236	---	502386-0234	---	502386-0232	---	502386-0231	---	502386-0272	---	2	
コネクタ シリーズ CONNECTOR SERIES	製品番号 MATERIAL NO.	極数 (XT. NO.)	コネクタ シリーズ CONNECTOR SERIES	製品番号 MATERIAL NO.	コネクタ シリーズ CONNECTOR SERIES	製品番号 MATERIAL NO.	コネクタ シリーズ CONNECTOR SERIES	製品番号 MATERIAL NO.	コネクタ シリーズ CONNECTOR SERIES	製品番号 MATERIAL NO.	コネクタ シリーズ CONNECTOR SERIES	製品番号 MATERIAL NO.	極数 (XT. NO.)

WITHOUT CAPTON TAPE																	
HSG COLOR : GREEN			HSG COLOR : BLUE			HSG COLOR : YELLOW			HSG COLOR : RED			HSG COLOR : BLACK			HSG COLOR : NATURAL		
502386-**26	502386-1546	---	502386-1544	---	---	502386-1542	---	502386-1541	---	502386-1570	---	15					
	502386-1446	---	502386-1444	---	---	502386-1442	---	502386-1441	---	502386-1470	---	14					
	502386-1346	---	502386-1344	---	---	502386-1342	---	502386-1341	---	502386-1370	---	13					
	502386-1246	---	502386-1244	---	---	502386-1242	---	502386-1241	---	502386-1270	---	12					
	502386-1146	---	502386-1144	---	---	502386-1142	---	502386-1141	---	502386-1170	---	11					
	502386-1046	---	502386-1044	---	---	502386-1042	---	502386-1041	---	502386-1070	---	10					
	502386-0946	502386-**24	502386-0944	502386-**23	502386-0943	502386-**22	502386-0942	502386-**21	502386-0941	502386-**09	502386-0970	---	9				
	502386-0846	---	502386-0844	---	---	502386-0842	---	502386-0841	---	502386-0870	---	8					
	502386-0746	---	502386-0744	---	---	502386-0742	---	502386-0741	---	502386-0770	---	7					
	502386-0646	---	502386-0644	---	---	502386-0642	---	502386-0641	---	502386-0670	---	6					
	502386-0546	---	502386-0544	---	---	502386-0542	---	502386-0541	---	502386-0570	---	5					
	502386-0446	---	502386-0444	---	---	502386-0442	---	502386-0441	---	502386-0470	---	4					
	502386-0346	---	502386-0344	---	---	502386-0342	---	502386-0341	---	502386-0370	---	3					
	502386-0246	---	502386-0244	---	---	502386-0242	---	502386-0241	---	502386-0270	---	2					
	コネクタ シリーズ CONNECTOR SERIES	製品番号 MATERIAL NO.	コネクタ シリーズ CONNECTOR SERIES	製品番号 MATERIAL NO.	コネクタ シリーズ CONNECTOR SERIES	製品番号 MATERIAL NO.	コネクタ シリーズ CONNECTOR SERIES	製品番号 MATERIAL NO.	コネクタ シリーズ CONNECTOR SERIES	製品番号 MATERIAL NO.	コネクタ シリーズ CONNECTOR SERIES	製品番号 MATERIAL NO.	極数 (XT. NO.)				

REVISED IEC NO. J2013-0870 DRAWN BY T. MIYAZAKI 2013/02/07 CHECKED BY K. ASAKAWA 2013/02/13 APPROVED BY YO. ITO 2013/02/13	GENERAL TOLERANCES (UNLESS SPECIFIED)		DIMENSION STYLE MM ONLY		SCALE ---	DESIGN UNITS METRIC	THIRD ANGLE PROJECTION
	10 UNDER	± 0.2	DRAWN BY	DATE	TITLE		
	10 OVER 30 UNDER	± 0.25	T. MIYAZAKI	2006/10/16	1.25 W/B CONN. SINGLE R/A REC. EMBTP PKG		
	30 OVER	± 0.3	K. ASAKAWA	2006/10/16			
	ANGULAR	± 3 °	APPROVED BY	DATE			
DRAFT WHERE APPLICABLE MUST REMAIN WITHIN DIMENSIONS		SEE TABLE		MATERIAL NO.	DOCUMENT NO.	SHEET NO.	
					SD-502386-003	2 OF 2	
THIS DRAWING CONTAINS INFORMATION THAT IS PROPRIETARY TO MOLEX INCORPORATED AND SHOULD NOT BE USED WITHOUT WRITTEN PERMISSION							

Contact us: sales@integrated-circuit.com Website: www.integrated-circuit.com

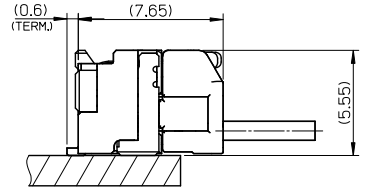
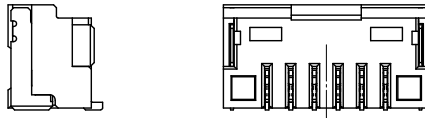
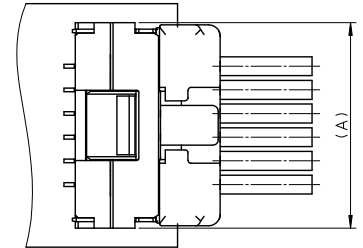
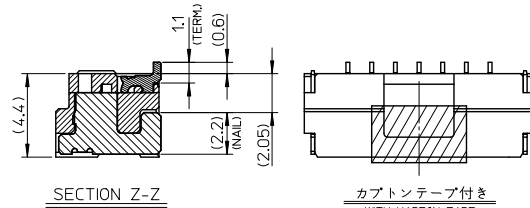
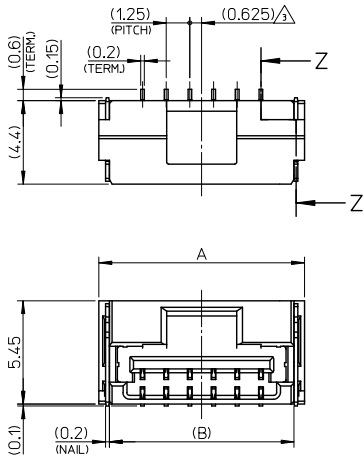

NOTES

- 嵌合相手: 502380-****
MATE WITH: 502380-****
- 端子テール部 及び ネイルの平坦度: 0.1MAX,
TAIL AND NAIL COPLANARITY TO BE 0.1 MAX.
- 極数/2=偶数に適用。
APPLY FOR CKT. SIZE / 2 = EVEN.
- 端子テール部 及び ネイルに錫めっきを使用しているため、
外観に摺動痕が付く場合が御座います。
THE WOUND OF FRICTION MIGHT ADHERE TO EXTERNALS
BECAUSE THE TIN PLATING IS USED FOR THE TAIL AND NAIL.
- 本製品のプラスチック部に黒点等が確認される場合や
色合いが異なる場合がありますが、製品性能に影響はありません。
THERE IS NO INFLUENCE IN THE PRODUCT PERFORMANCE THOUGH
THE BLACK SPOT ETC. MIGHT BE CONFIRMED TO THE PLASTIC PART
OF THIS PRODUCT AND THE SHADE MIGHT BE DIFFERENT.
- ELV 及び RoHS 適合品
ELV AND RoHS COMPLIANT

嵌合図
MATED CONNECTORS

3.4	7.5	11	12.1	502386-0707	7
3.4	6.25	9.75	10.85	502386-0607	6
3.4	5	8.5	9.6	502386-0507	5
3.4	3.75	7.25	8.35	502386-0407	4
2.6	2.5	6	7.1	502386-0307	3
2.2	1.25	4.75	5.85	502386-0207	2

番号 NO.	部品 PART	材質 MATERIAL
①	ハウジング HOUSING	耐熱性樹脂 UL94V-0 色: ナチュラル HEATPROOF RESIN UL94V-0 COLOR: NATURAL
②	ターミナル TERMINAL	銅合金 COPPER ALLOY 金めっき: 0.1 micro-meter MIN. GOLD ニッケルめっき(下地): 1.0 micro-meter MIN. NICKEL (UNDER PLATING)
③	ネイル NAIL	銅合金 COPPER ALLOY 錫めっき: 1.0 micro-meter MIN. TIN ニッケルめっき(下地): 1.0 micro-meter MIN. NICKEL (UNDER PLATING)

RELEASED EC NO. J2016-0012 DRAWN: TAKAIKE CHKD: KASAKAWA APPR: NUKITA REV A	GENERAL TOLERANCES (UNLESS SPECIFIED)		DIMENSION STYLE MM ONLY		SCALE	DESIGN UNITS METRIC	THIRD ANGLE PROJECTION
	0.25 UNDER	UNDER	±0.03	DRAWN BY	DATE	TITLE	
	0.25 OVER	0.5 UNDER	±0.05	TAKAIKE	2015/02/23	1.25 W/B CONN. SINGLE R/A REC. ASS'Y 2-7CKT.	
	0.5 OVER	1.0 UNDER	±0.1	CHECKED BY	DATE		
	1.0 OVER	10 UNDER	±0.2	KASAKAWA	2015/07/21		
	10 OVER	30 UNDER	±0.25	APPROVED BY	DATE		
	30 OVER		±0.3	NUKITA	2015/07/21		
	ANGULAR	±3 °		MATERIAL NO.			
	DRAFT WHERE APPLICABLE MUST REMAIN WITHIN DIMENSIONS			SEE TABLE	DOCUMENT NO.	SD-502386-006	SHEET NO. 1 OF 2
	THIS DRAWING CONTAINS INFORMATION THAT IS PROPRIETARY TO MOLEX INCORPORATED AND SHOULD NOT BE USED WITHOUT WRITTEN PERMISSION						

Contact us: sales@integrated-circuit.com Website: www.integrated-circuit.com



2 CKT.

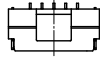

5 CKT.



3 CKT.

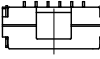

6 CKT.



4 CKT.

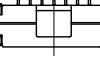

7 CKT.

極数の種類
KIND OF CKT. NO.(FRONT VIEW)

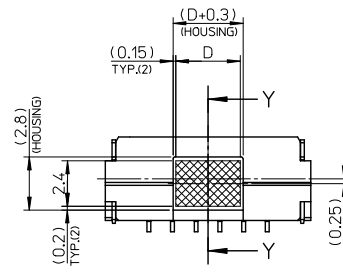

吸着範囲
VACUUM AREA

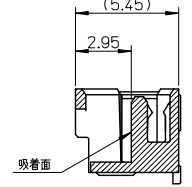

SECTION Y-Y

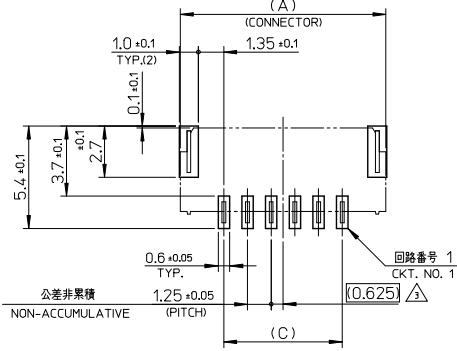

基板パターンレイアウト (参考)
RECOMMENDED P.C.B. PATTERN LAYOUT (REF.)

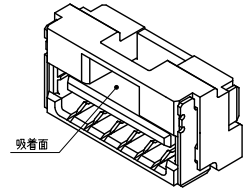

RELEASED IEC NO. J2016-0012 DRAWN: TAKAIKE CHIKIDAKAKAWA APPR: NUKITA 2015/02/23 2015/07/21 2015/07/21	GENERAL TOLERANCES (UNLESS SPECIFIED)			DIMENSION STYLE		SCALE	DESIGN UNITS	THIRD ANGLE PROJECTION 0.25 W/B CONN. SINGLE R/A REC. ASS'Y 2-7CKT. molex DOCUMENT NO. SD-502386-006 SHEET NO. 2 OF 2
	0.25 UNDER	UNDER	± 0.03	MM ONLY			METRIC	
	0.25 OVER	0.5 UNDER	± 0.05	DRAWN BY DATE		TITLE		
	0.5 OVER	1.0 UNDER	± 0.1	TAKAIKE 2015/02/23				
	1.0 OVER	10 UNDER	± 0.2	CHECKED BY DATE				
10 OVER	30 UNDER	± 0.25	KASAKAWA 2015/07/21					
30 OVER		± 0.3	APPROVED BY DATE					
ANGULAR	± 3 °		NUKITA 2015/07/21					
DRAFT WHERE APPLICABLE MUST REMAIN WITHIN DIMENSIONS			MATERIAL NO.		SEE TABLE			