

Excellent Integrated System Limited

Stocking Distributor

Click to view price, real time Inventory, Delivery & Lifecycle Information:

[Panasonic Electronic Components](#)
[ECK-TBC472MF](#)

For any questions, you can email us directly:

sales@integrated-circuit.com

Panasonic

Ceramic Capacitors (Safety Regulation SMD)

Ceramic Capacitors (safety Regulations) For Surface Mountings Types BC and FC

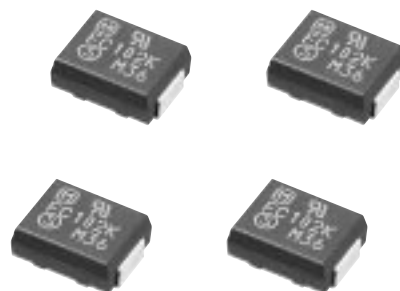

Features

- Resin molded SMD type for reflow soldering
- High reliability through disc capacitor element molded construction
- Safety requirement approved by UL, SEMKO, NEMKO, FIMKO, DEMKO and KTL (for Type FC)
- Addition new smaller type (Type FC 5.7 × 4.5mm)

Recommended Application

- IT equipment as analog MODEM, XDSL MODEM
- AC primary circuit of AC adapter, Charger, DC-DC converter, On-board type power modul Etc.

Explanation of Part Numbers

1	2	3	4	5	6	7	8	9	10	11	12	(Examples)
E	C	K	T	B	C	1	0	2	M	E		
Product Code		Packaging Style		Type		Nominal Capacitance		Cap. Tolerance		Temp. Char.		Suffix
Code	Class	Code	Style	Code	Type	(Ex.)	Capacitance	Code	Tol.	Code	Temp. Char.	
ECC	Class1	S	Bulk	BC	Type BC	050	5 pF	C	±0.25 pF	G	SL/GP	
ECK	Class2	T	Taped type	FC	Type FC	100	10 pF	D	±0.5 pF	B	B/Y5P	
						470	47 pF	F	±1 pF	E	E/Y5U	
						101	100 pF	J	±5 %	F	F/Y5V	
						221	220 pF	K	±10 %			
						102	1000 pF	M	±20 %			

Construction

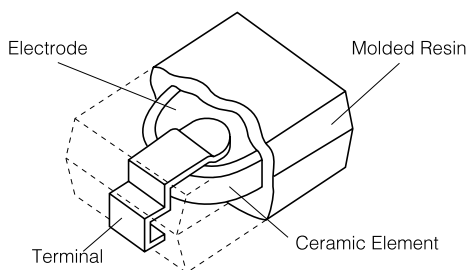

Dimensions in mm (not to scale)

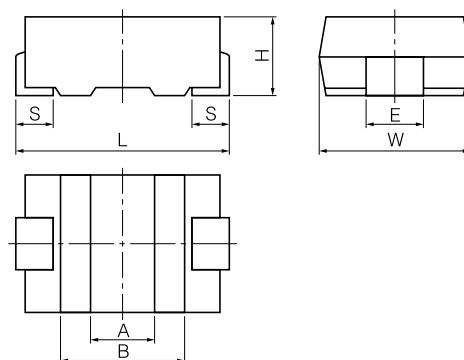

Unit: (mm)

Symbol	L	W	H	S	E	A	B
Dim Type BC	7.1±0.5	6.3±0.3	2.5±0.3	1.45±0.30	2.5±0.2	(2.0)	(3.7)
(mm) Type FC	5.7±0.5	4.5±0.3	2.3max	0.85±0.30	2.5±0.2	(1.7)	(3.1)

Precaution for Handling

See Page 93 to 95

Packaging Informations

See Page 96 to 97

Panasonic

Ceramic Capacitors (Safety Regulation SMD)

Specifications

Characteristics	Temp. Char. SL/GP	Temp. Char. B/Y5P, E/Y5U, F/Y5V
Operating Temperature Range	-25 to 100 °C (-25 to 85 °C for UL approved)	
Rated Voltage	250 VAC	
Dielectric Withstanding Voltage	1500 VAC for 1 min	
Capacitance	Within the specified tolerance, when measured at 1 MHz±20 %, 1 to 5 Vrms. and 20 °C	Within the specified tolerance, when measured at 1 kHz±20 %, 1 to 5 Vrms. and 20 °C
Q or Dissipation Factor tan δ	30 pF or under Q ≥ 200+10 C (C:Cap.pF) over 30 pF Q ≥ 500 at 1 MHz±20 %, 1 to 5 Vrms. and 20 °C	tan δ ≤ 0.025 at 1 kHz±20 %, 1 to 5 Vrms. and 20 °C
Insulation Resistance	10000 M Ω min. at 500 VDC and 1 minute electrification	
Temperature Characteristics	Temperature Coefficient: +350 to -1000 ppm/°C over the temperature range 20 to 85 °C	Char. Max. Cap. Change Temp. Range
		B/Y5P ±10 % -25 to 85 °C
		E/Y5U +20, -55 %
		F/Y5V +30, -80 %

Related Standards and Certificate Number

Certification Body	Related Standard	Certificate Number		Sub-Class	Rated Voltage	Dielectric Withstanding Voltage	Operating Temperature Range
		Type BC	Type FC				
UL (USA)	UL1414*	E62674	—	—	250 VAC	1500 VAC	-25 to 85 °C
	UL1414 6th Ed.	—	E62674	Y2		2000 VAC	
	CSA C22.2 No.1*	E62674	—	—		1500 VAC	
SEMKO (Sweden)	EN132 400:1994 Sub-class Y2 (IEC 60384-14 2nd.Ed.)	0026049/01	0101074/01 0126276/01	Y2	250 VAC	1500 VAC	-25 to 100 °C
FIMKO (Finland)		—	FI 16588 FI 17348				
DEMKO (Denmark)		—	310914-01 310698-01				
NEMKO (Norway)		—	P01101830 P01100665				
KTL (Korea)		K60384-14 (IEC60384-14 2nd Ed.)	—				

Note : * is for Line-by-pass capacitors. Certification Number sometimes changes with the change of the approval contents so on. KTL mark is indicated on the label.

Packaging Specifications

Standard Packing Quantity

Embossed taping: 2000 pcs./reel for Type BC

3000 pcs./reel for Type FC

Reel

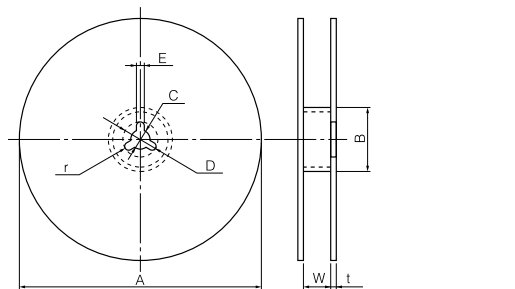

Symbol	A	B	C	D	E	W	t	r
Dim. (mm)	330±5	60 min.	13.0±0.5	21.0±1.0	2.0±0.5	13.5±1.5	2.0±0.5	R1.0

Embossed taping

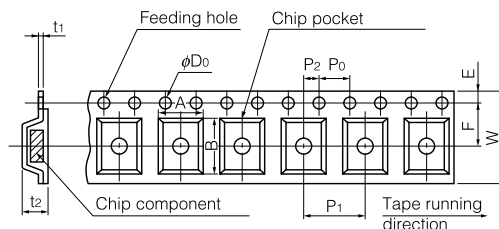

Symbol	A	B	W	F	E	P ₁	P ₂	P ₀	φD ₀	t ₁	t ₂
Dim. (mm)	Type BC	6.5 ±0.2	7.5 ±0.2	12.0 ±0.3	5.5 ±0.1	1.75 ±0.10	8.0 ±0.1	2.00 ±0.05	4.0 ±0.1	1.5 ±0.1	3.2 ±0.3
	Type FC	4.8 ±0.2	6.0 ±0.2	—	—	—	—	—	—	0	2.8 ±0.3

Leader Part and Taped End

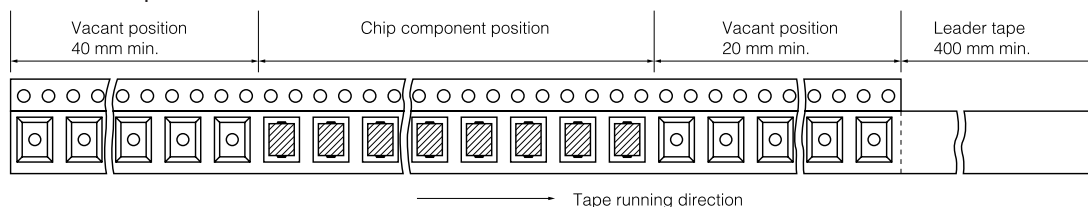

Panasonic

Ceramic Capacitors (Safety Regulation SMD)

Rating and Characteristics

Type Name	Part Number	Capacitance (pF)	Cap. Tolerance	Temp. Char	Dimensions in mm
Type BC	ECCTBC100DG	10	±0.5 pF	SL/GP	7.1L×6.3W×2.5H
	ECCTBC150JG	15	±5 %	SL/GP	
	ECCTBC220JG	22	±5 %	SL/GP	
	ECCTBC330JG	33	±5 %	SL/GP	
	ECCTBC470JG	47	±5 %	SL/GP	
	ECCTBC680JG	68	±5 %	SL/GP	
	ECKTBC101KB	100	±10 %	B/Y5P	
	ECKTBC151KB	150	±10 %	B/Y5P	
	ECKTBC221KB	220	±10 %	B/Y5P	
	ECKTBC331KB	330	±10 %	B/Y5P	
	ECKTBC471KB	470	±10 %	B/Y5P	
	ECKTBC681KB	680	±10 %	B/Y5P	
	ECKTBC102ME	1000	±20 %	E/Y5U	
	ECKTBC152ME	1500	±20 %	E/Y5U	
	ECKTBC222ME	2200	±20 %	E/Y5U	
Type FC	ECKTBC332MF	3300	±20 %	F/Y5V	5.7L×4.5W×2.3H
	ECKTBC472MF	4700	±20 %	F/Y5V	
	ECCTFC050DG	5	±0.5 pF	SL/GP	
	ECCTFC100DG	10	±0.5 pF	SL/GP	
	ECCTFC150JG	15	±5 %	SL/GP	
	ECCTFC220JG	22	±5 %	SL/GP	
	ECCTFC330JG	33	±5 %	SL/GP	
	ECKTFC470KB	47	±10 %	B/Y5P	
	ECKTFC680KB	68	±10 %	B/Y5P	
	ECKTFC101KB	100	±10 %	B/Y5P	
	ECKTFC151KB	150	±10 %	B/Y5P	
	ECKTFC221KB	220	±10 %	B/Y5P	
	ECKTFC331KB	330	±10 %	B/Y5P	
	ECKTFC471KB	470	±10 %	B/Y5P	
	ECKTFC681KB	680	±10 %	B/Y5P	
ECKTFC821KB	820	±10 %	B/Y5P		
ECKTFC102KB	1000	±10 %	B/Y5P		
ECKTFC102ME	1000	±20 %	E/Y5U		
ECKTFC152KB	1500	±10 %	B/Y5P		
ECKTFC152MF	1500	±20 %	F/Y5V		
ECKTFC222KB	2200	±10 %	B/Y5P		
ECKTFC222MF	2200	±20 %	F/Y5V		

Notes *: Other capacitance values are available by special order.

Typical Characteristics

Temperature Characteristics

Char. SL/GP
(Temp.Coeff.: +350 to -1000 ppm/°C)

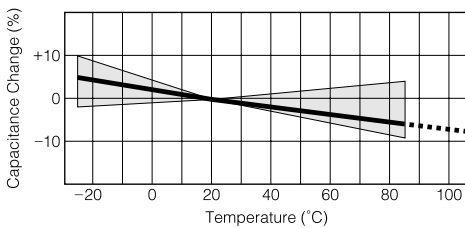

Char. B/Y5P
Temp.Range:-25 to 85 °C
Max.Cap.Change:± 10 %

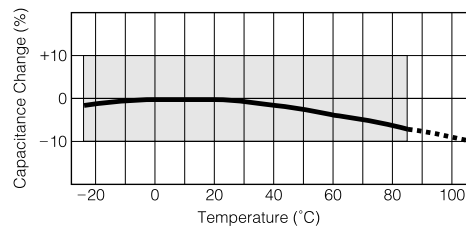

Char. E/Y5U (Temp.Range:-25 to 85 °C
max.Cap.Change:+20, -55 %)

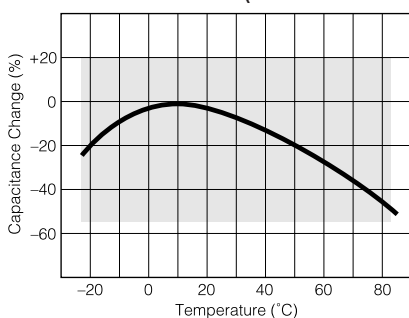

Char. F/Y5V (Temp.Range:-25 to 85 °C
max.Cap.Change:+30, -80 %)

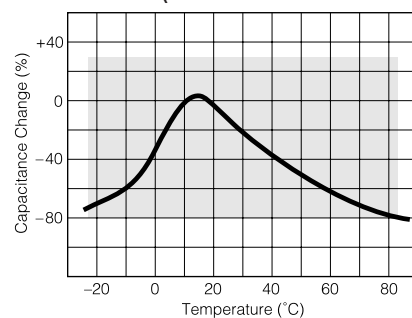

Panasonic

Ceramic Capacitors (Safety Regulation SMD)

● Impedance vs. Frequency Characteristics

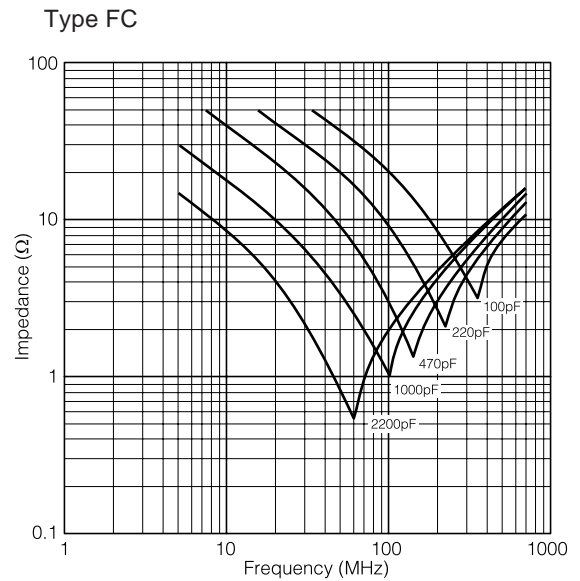
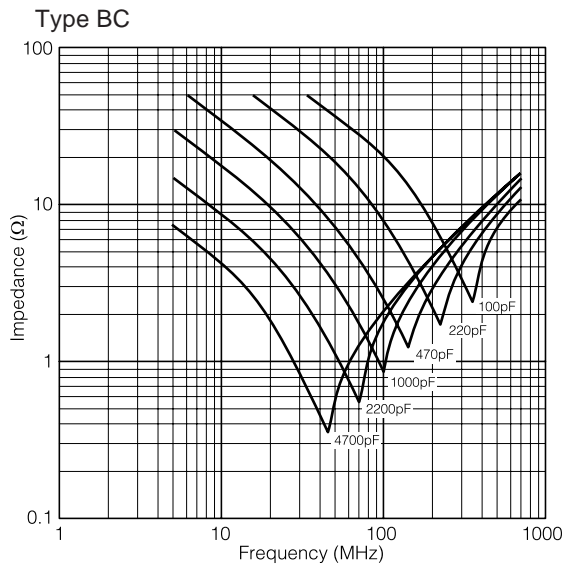

● Current vs. Voltage (Leakage Current Characteristics)

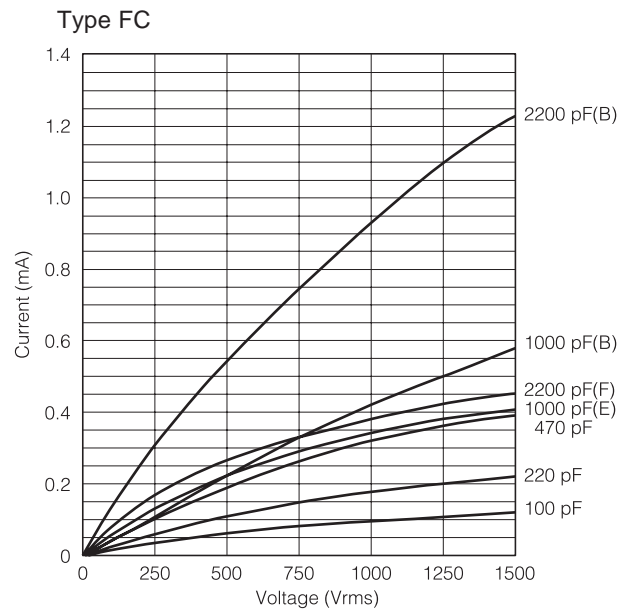
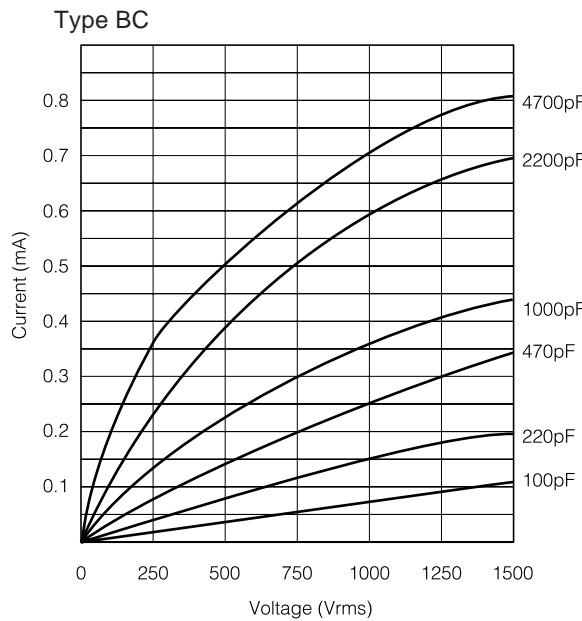

■ Application Examples

● MODEM

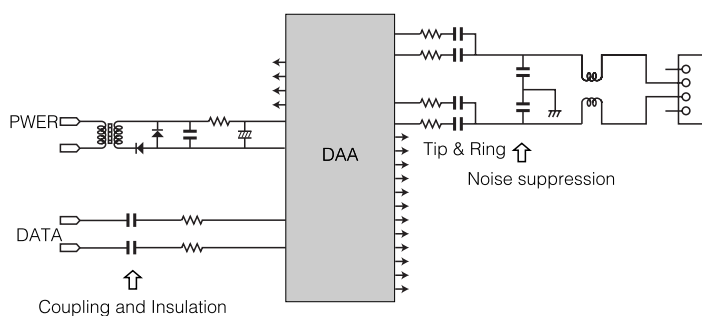

● Primary circuit of Switching Power Supply

