

Excellent Integrated System Limited

Stocking Distributor

Click to view price, real time Inventory, Delivery & Lifecycle Information:

[TE Connectivity AMP Connectors](#)
[176139-1](#)

For any questions, you can email us directly:

sales@integrated-circuit.com



Distributor of TE Connectivity AMP Connectors: Excellent Integrated System Limited
 Datasheet of 176139-1 - CONN EDGE CARD 49POS VERT PCB

DRAWING MADE IN BRISBANE AUSTRALIA
 THIS DRAWING IS UNCLASSIFIED AND RELEASED FOR PUBLICATION
 © COPYRIGHT 19 BY AMP INCORPORATED. ALL INTERNATIONAL RIGHTS RESERVED.

REV	DATE	BY	CHKD	DESCRIPTION
1	05/11/98	RS	AV	REVISED PER 0051-0024-98
2	06/09/99	RS	SP	REVISED PER 0051-0019-99
3	06/09/99	RS	SP	REVISED PER 0052-0059-99

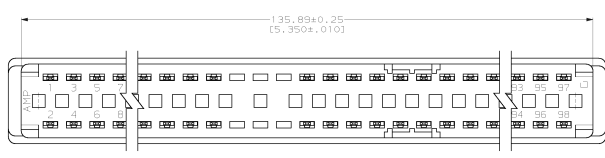
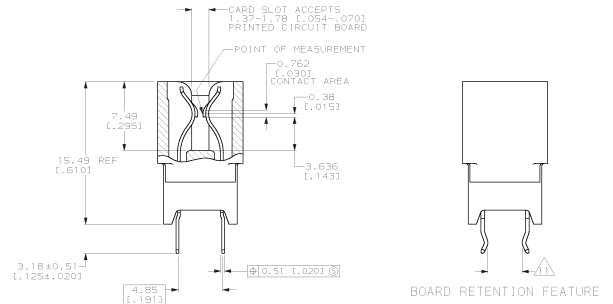
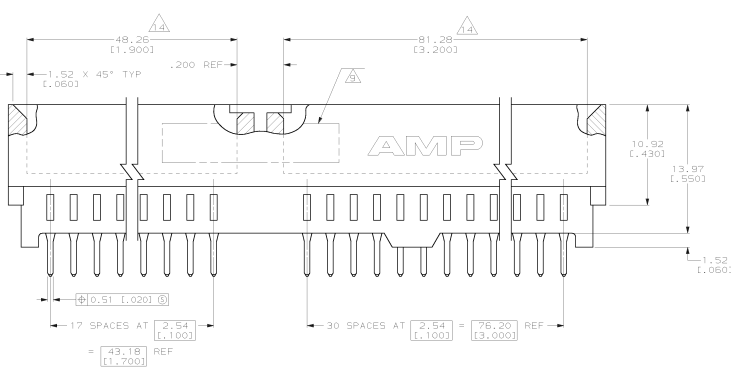
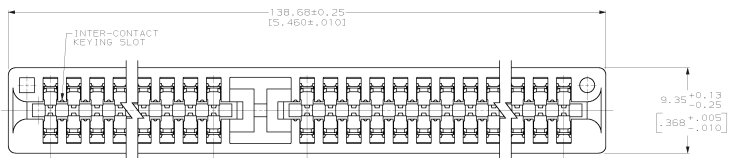

REV	DATE	BY	CHKD	DESCRIPTION
1	05/11/98	RS	AV	REVISED PER 0051-0024-98
2	06/09/99	RS	SP	REVISED PER 0051-0019-99
3	06/09/99	RS	SP	REVISED PER 0052-0059-99

DO NOT SCALE PRINT.
 UNLESS SPECIFIED DIMENSIONS IN MM (INCHES)
 TOLERANCES UNLESS SPECIFIED
 3 PLS DEC ± 0.13 (0.005)
 1 PLS DEC ± 0.025 (0.001)
 ANGLES ± 0.5°

HOUSING: CONTACT:

FINISH CONTACT:

OR 7/30/97 0 BROWN
 CHC 7/20/97 M PAVLOVICH
 APPD 2/30/97 M PAVLOVICH
 APPD 7/30/97 D SARKER
 PRODUCT SPEC 108-1248

AMP INCORPORATED
 Harrisburg, PA 17105-3608

CONNECTOR ASSY, EDGE CARD, 2.54 [1.00] ↓

SIZE D CASE CODE 00779 DRAWING NO 176139
 SCALE 5:1 SHEET 1 OF 2



CUSTOMER DRAWING

10-111-98 12.52.17 amp/ES76 model/isp/v254/8a/07/dp/0100/amp/ES76/8a/8a

DRAWING MADE IN UNISEX ANGLE PROJECTION
 THIS DRAWING IS UNLESS SPECIFIED RELEASED FOR PUBLICATION
 © COPYRIGHT 19 BY AMP INCORPORATED. ALL INTERNATIONAL RIGHTS RESERVED.

REV	AD	DATE	ZONE	LEN	DESCRIPTION	DATE	APPR
1	U				SEE SHEET 1		

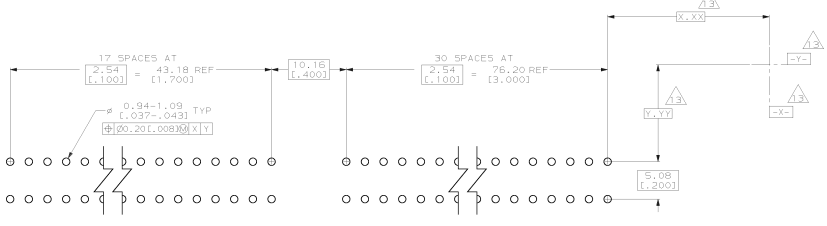
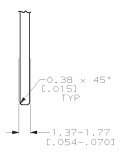
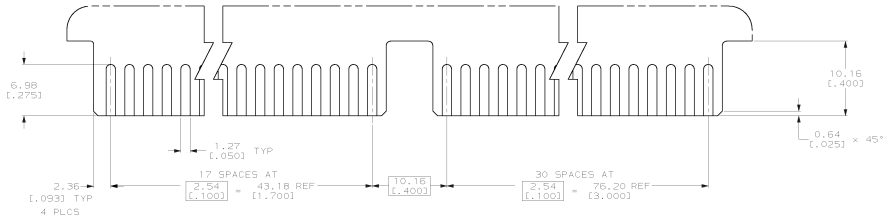

- △ HOUSING; GLASS FILLED POLYESTER; COLOR; BLACK.
- △ CONTACT; PHOSPHOR BRONZE.
- △ NICKEL PLATE; 0.00127 [0.00050] MIN - ALL OVER.
- △ TIN-LEAD PLATE; 0.00254 [0.00100] MIN - SOLDER POSTS.
- △ GOLD FLASH IN CONTACT AREA.
- △ GOLD PLATE; 0.00038 [0.00015] MIN - CONTACT AREA.
- △ GOLD PLATE; 0.00076 [0.00030] MIN - CONTACT AREA.
- △ NICKEL PLATE PER MIL-S-45204.
- △ GOLD PLATE PER 00-N-290.
- △ AMP, CSA LOGO, PART NUMBER AND DATE CODE ARE MARKED IN APPROXIMATE AREA SHOWN, EITHER SIDE.
- 10. RECOMMENDED PCB FINISHED HOLE DIA; 1.02±0.08 [0.40±0.03].
- 11. THE RETENTIVE FEATURE OF THIS CONNECTOR IS DESIGNED FOR FULL SEATING IN .0625-.008 THICK CIRCUIT BOARDS. FOR APPLICATIONS IN BOARDS OF OTHER THICKNESSES CONTACT AMP INCORPORATED.
- △ PACKAGE 20 CONNECTOR PER GANG OF TUBE.
- △ DATUMS AND BASIC DIMENSIONS TO BE DETERMINED BY CUSTOMER.
- △ CARD SLOT DIMENSION.

DO NOT SCALE PRINT.		DR 7/30/97	AMP Incorporated Harrisburg, PA 17105-3608		
UNLESS SPECIFIED DIMENSIONS IN MM (INCHES)		CHK 7/30/97			
TOLERANCES ON F.P.C. DIMS ±.13 (L.050)		APPR 2/20/97	NAME CONNECTOR ASSY, EDGE CARD, 2.54 [1.00] ⌀		
T.P.C. DIMS ±.04		M. PAVLOVICH			
SEE SHEET 1	PRODUCT SPEC	108-1248	SIZE	CASE CODE	DRAWING NO.
SEE SHEET 1	APPLICATION SPEC	-	D	00779	176139
SEE SHEET 1	WEIGHT	-	SCALE	4:1	SHEET 2 OF 2



CUSTOMER DRAWING