

Excellent Integrated System Limited

Stocking Distributor

Click to view price, real time Inventory, Delivery & Lifecycle Information:

[STMicroelectronics](#)
[STTH30R02DJF-TR](#)

For any questions, you can email us directly:

sales@integrated-circuit.com



STTH30R02DJF

Ultrafast recovery diode high efficiency

Datasheet – production data

Features

- Suited for DC/DC converts
- Low losses
- High T_j
- High surge current capability
- High energy avalanche capability
- 1 mm package thickness
- ECOPACK[®]2 compliant component

Description

High performance diode suited for high frequency DC to DC converters. Packaged in PowerFLAT[™] 5x6, this device is intended for use in low voltage high frequency inverters.

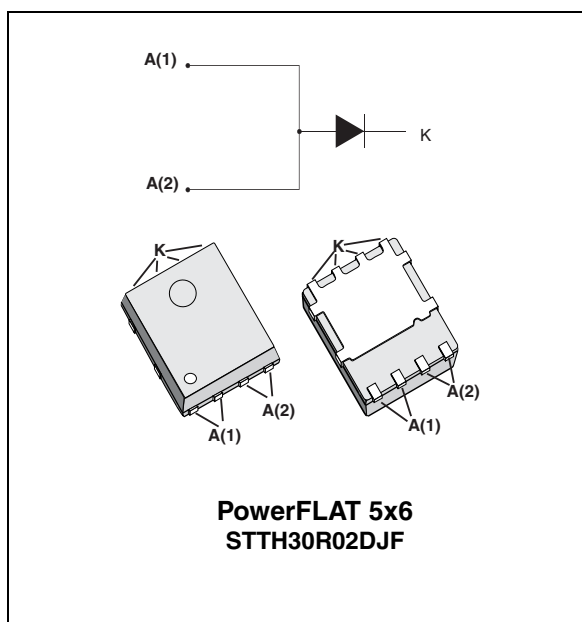

Table 1. Device summary

Symbol	Value
$I_{F(AV)}$	30 A
V_{RRM}	200 V
T_j	175 °C
V_F (typ)	0.8 V
t_{rr} (typ)	27 ns

TM: PowerFLAT is a trademark of STMicroelectronics

1 Characteristics

Table 2. Absolute ratings (limiting values with anode terminals short-circuited)

Symbol	Parameter	Value	Unit
V_{RRM}	Repetitive peak reverse voltage	200	V
$I_{F(RMS)}$	Forward rms current	45	A
$I_{F(AV)}$	Average forward current	$T_c = 105\text{ °C}$ $\delta = 0.5$	A
I_{FSM}	Surge non repetitive forward current	$t_p = 10\text{ ms}$ sinusoidal	A
T_{stg}	Storage temperature range	-65 to + 175	°C
T_j	Maximum operating junction temperature	175	°C

Table 3. Thermal parameter

Symbol	Parameter	Maximum	Unit
$R_{th(j-c)}$	Junction to case	2.0	°C/W

Table 4. Static electrical characteristics (anode terminals short-circuited)

Symbol	Parameter	Test conditions	Min.	Typ	Max.	Unit	
$I_R^{(1)}$	Reverse leakage current	$T_j = 25\text{ °C}$	$V_R = 200V$		10	μA	
		$T_j = 125\text{ °C}$		10	100		
$V_F^{(2)}$	Forward voltage drop	$T_j = 25\text{ °C}$	$I_F = 30\text{ A}$		1	1.15	V
		$T_j = 150\text{ °C}$		0.80	0.95		

1. Pulse test: $t_p = 5\text{ ms}$, $\delta < 2\%$

2. Pulse test: $t_p = 380\text{ }\mu s$, $\delta < 2\%$

To evaluate the maximum conduction losses use the following equation:

$$P = 0.77 \times I_{F(AV)} + 0.006 I_{F(RMS)}^2$$

STTH30R02DJF

Characteristics

Table 5. Recovery characteristics

Symbol	Parameter	Test conditions		Min.	Typ	Max.	Unit
t_{rr}	Reverse recovery time	$T_j = 25\text{ }^\circ\text{C}$	$I_F = 1\text{ A}$ $V_r = 30\text{ V}$ $di_F/dt = 100\text{ A}/\mu\text{s}$		27	35	ns
			$I_F = 1\text{ A}$ $V_r = 30\text{ V}$ $di_F/dt = 50\text{ A}/\mu\text{s}$		38	50	
I_{RM}	Reverse recovery current	$T_j = 125\text{ }^\circ\text{C}$	$I_F = 30\text{ A}$, $di_F/dt = -200\text{ A}/\mu\text{s}$, $V_{CC} = 160\text{ V}$		6.0	8.0	A
S_{factor}	Reverse recovery softness factor				0.3		-
Q_{rr}	Reverse recovery charges				140		nC

Table 6. Turn-on switching characteristics

Symbol	Parameter	Test conditions		Min.	Typ	Max.	Unit
t_{fr}	Forward recovery time	$T_j = 25\text{ }^\circ\text{C}$	$I_F = 30\text{ A}$ $di_F/dt = 200\text{ A}/\mu\text{s}$ $V_{FR} = 1.3\text{ V}$			300	ns
V_{FP}	Forward recovery voltage				2.3	3.5	V

Figure 1. Average forward power dissipation versus average forward current **Figure 2. Forward voltage drop versus forward current**

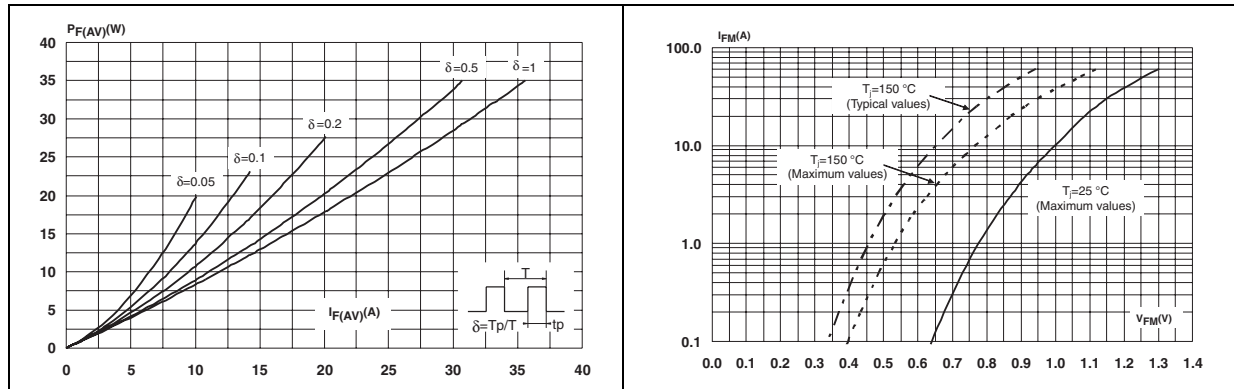

Characteristics

STTH30R02DJF

Figure 3. Relative variation of thermal impedance junction to case versus pulse duration

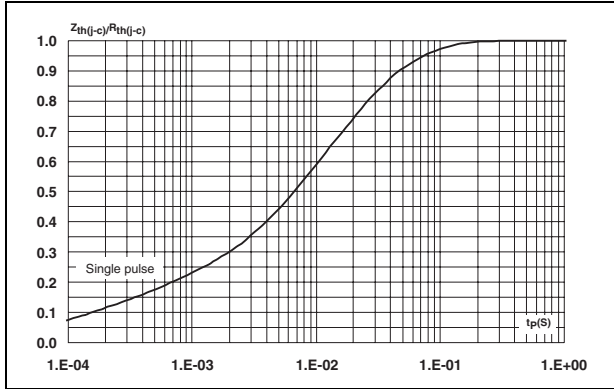

Figure 4. Peak reverse recovery current versus di_F/dt (typical values)

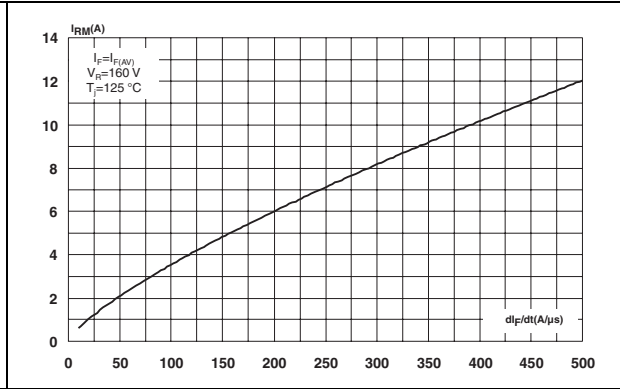

Figure 5. Reverse recovery time versus di_F/dt (typical values)

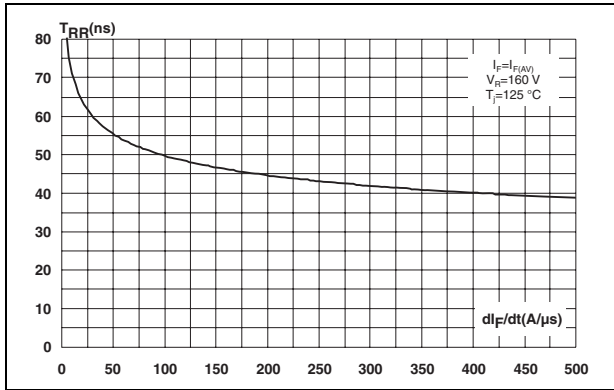

Figure 6. Reverse recovery charges versus di_F/dt (typical values)

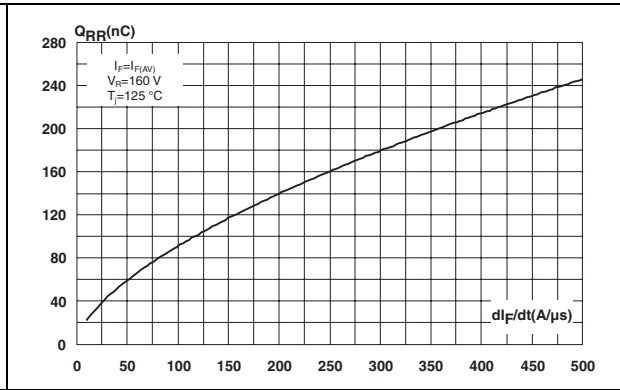

Figure 7. Softness factor versus di_F/dt (typical values)

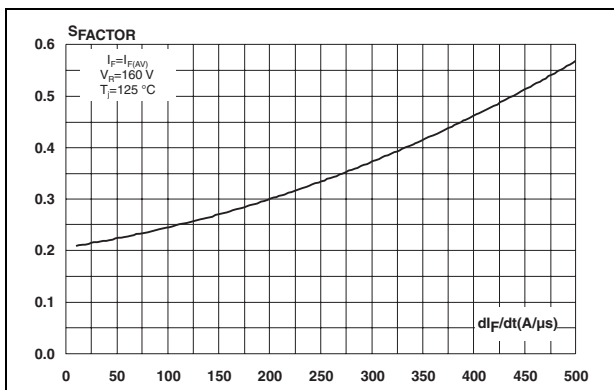
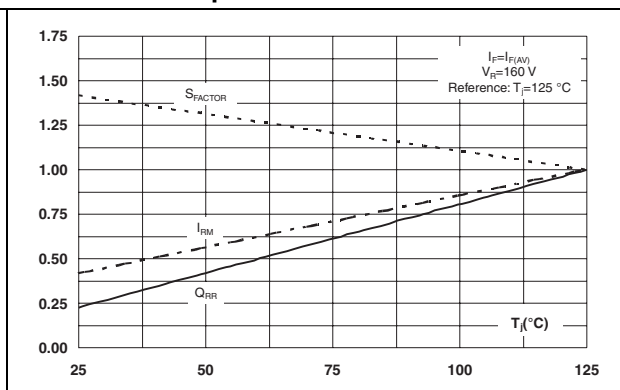

Figure 8. Relative variations of dynamic parameters versus junction temperature



STTH30R02DJF

Characteristics

Figure 9. Transient peak forward voltage versus di_F/dt (typical values)

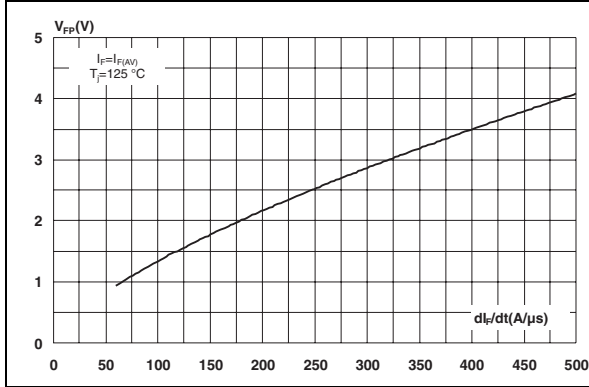

Figure 10. Forward recovery time versus di_F/dt (typical values)

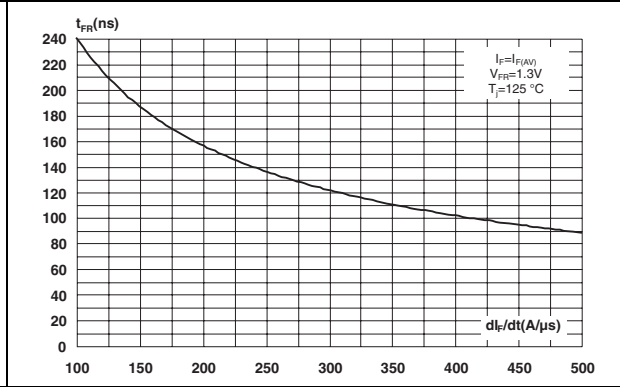

Figure 11. Junction capacitance versus reverse voltage applied (typical values)

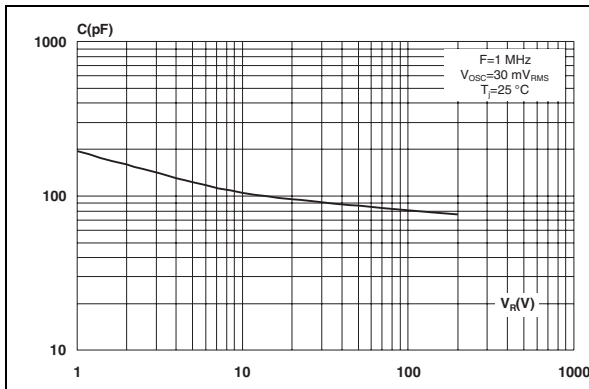
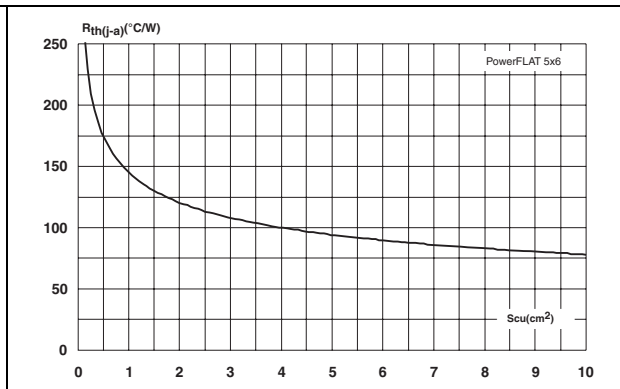

Figure 12. Thermal resistance junction to ambient versus copper surface under tab



Package information

STTH30R02DJF

2 Package information

- Epoxy meets UL94, V0
- Cooling method: by conduction (C)

In order to meet environmental requirements, ST offers these devices in different grades of ECOPACK® packages, depending on their level of environmental compliance. ECOPACK® specifications, grade definitions and product status are available at: www.st.com. ECOPACK® is an ST trademark.

Table 7. PowerFLAT 5x6 dimensions

Ref.	Dimensions					
	Millimeters			Inches		
	Min.	Typ.	Max.	Min.	Typ.	Max.
A	0.80		1.00	0.031		0.039
A1	0.02		0.05	0.001		0.002
A2		0.25			0.010	
b	0.30		0.50	0.012		0.020
D		5.20		0.205		
D2	4.11		4.31	0.162		0.170
e		1.27		0.050		
E		6.15		0.242		
E2	3.50		3.70	0.138		0.146
L	0.50		0.80	0.020		0.031
K	1.275		1.575	0.050		0.062

Figure 13. Footprint (dimensions in mm)

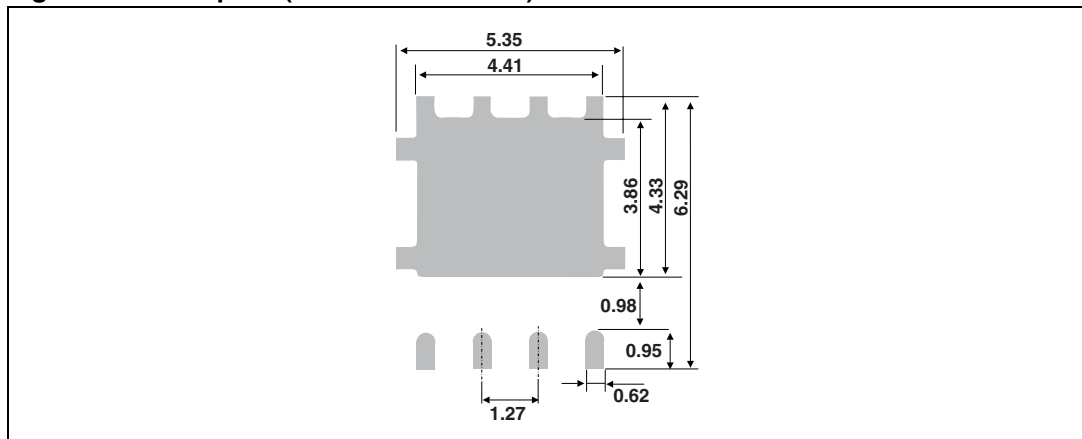

STTH30R02DJF

Package information

Figure 14. Tape and reel specifications

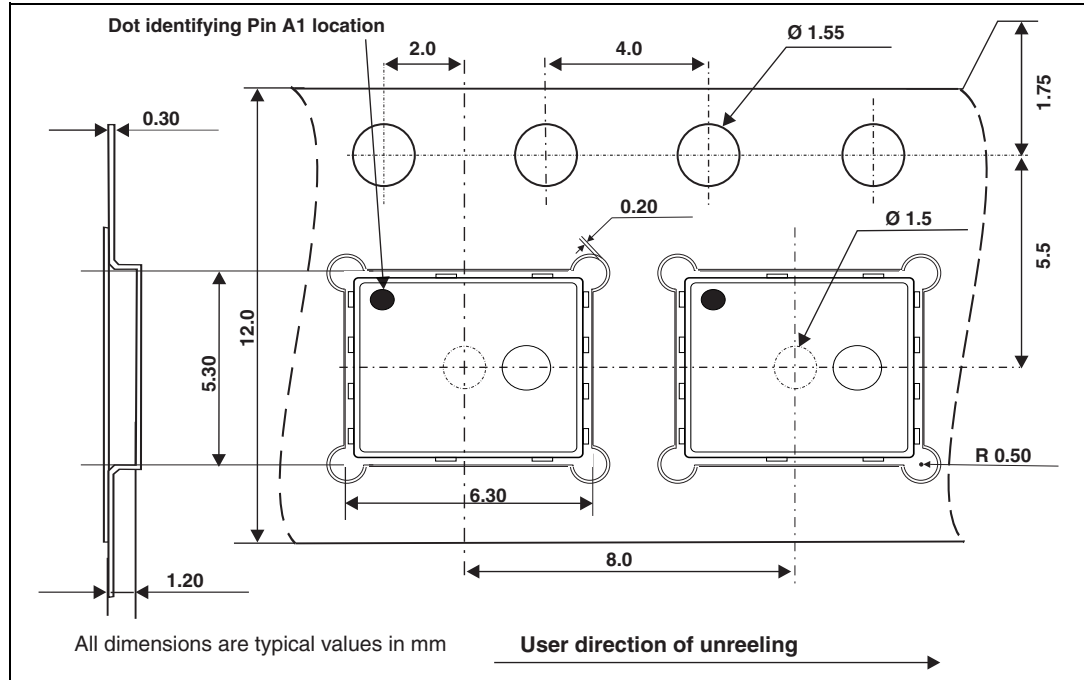

Ordering information

STTH30R02DJF

3 Ordering information

Table 8. Other information

Order code	Marking	Package	Weight	Base qty	Delivery mode
STTH30R02DJF-TR	TH30R 02	PowerFLAT 5x6	0.095 g	3000	Tape and Reel

4 Revision history

Table 9. Document revision history

Date	Revision	Changes
16-Mar-2012	1	First issue.

STTH30R02DJF

Please Read Carefully:

Information in this document is provided solely in connection with ST products. STMicroelectronics NV and its subsidiaries ("ST") reserve the right to make changes, corrections, modifications or improvements, to this document, and the products and services described herein at any time, without notice.

All ST products are sold pursuant to ST's terms and conditions of sale.

Purchasers are solely responsible for the choice, selection and use of the ST products and services described herein, and ST assumes no liability whatsoever relating to the choice, selection or use of the ST products and services described herein.

No license, express or implied, by estoppel or otherwise, to any intellectual property rights is granted under this document. If any part of this document refers to any third party products or services it shall not be deemed a license grant by ST for the use of such third party products or services, or any intellectual property contained therein or considered as a warranty covering the use in any manner whatsoever of such third party products or services or any intellectual property contained therein.

UNLESS OTHERWISE SET FORTH IN ST'S TERMS AND CONDITIONS OF SALE ST DISCLAIMS ANY EXPRESS OR IMPLIED WARRANTY WITH RESPECT TO THE USE AND/OR SALE OF ST PRODUCTS INCLUDING WITHOUT LIMITATION IMPLIED WARRANTIES OF MERCHANTABILITY, FITNESS FOR A PARTICULAR PURPOSE (AND THEIR EQUIVALENTS UNDER THE LAWS OF ANY JURISDICTION), OR INFRINGEMENT OF ANY PATENT, COPYRIGHT OR OTHER INTELLECTUAL PROPERTY RIGHT.

UNLESS EXPRESSLY APPROVED IN WRITING BY TWO AUTHORIZED ST REPRESENTATIVES, ST PRODUCTS ARE NOT RECOMMENDED, AUTHORIZED OR WARRANTED FOR USE IN MILITARY, AIR CRAFT, SPACE, LIFE SAVING, OR LIFE SUSTAINING APPLICATIONS, NOR IN PRODUCTS OR SYSTEMS WHERE FAILURE OR MALFUNCTION MAY RESULT IN PERSONAL INJURY, DEATH, OR SEVERE PROPERTY OR ENVIRONMENTAL DAMAGE. ST PRODUCTS WHICH ARE NOT SPECIFIED AS "AUTOMOTIVE GRADE" MAY ONLY BE USED IN AUTOMOTIVE APPLICATIONS AT USER'S OWN RISK.

Resale of ST products with provisions different from the statements and/or technical features set forth in this document shall immediately void any warranty granted by ST for the ST product or service described herein and shall not create or extend in any manner whatsoever, any liability of ST.

ST and the ST logo are trademarks or registered trademarks of ST in various countries.

Information in this document supersedes and replaces all information previously supplied.

The ST logo is a registered trademark of STMicroelectronics. All other names are the property of their respective owners.

© 2012 STMicroelectronics - All rights reserved

STMicroelectronics group of companies

Australia - Belgium - Brazil - Canada - China - Czech Republic - Finland - France - Germany - Hong Kong - India - Israel - Italy - Japan - Malaysia - Malta - Morocco - Philippines - Singapore - Spain - Sweden - Switzerland - United Kingdom - United States of America

www.st.com