

## Excellent Integrated System Limited

Stocking Distributor

Click to view price, real time Inventory, Delivery & Lifecycle Information:

[Molex Connector Corporation](#)  
[0550910774](#)

For any questions, you can email us directly:

[sales@integrated-circuit.com](mailto:sales@integrated-circuit.com)

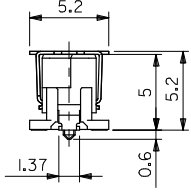
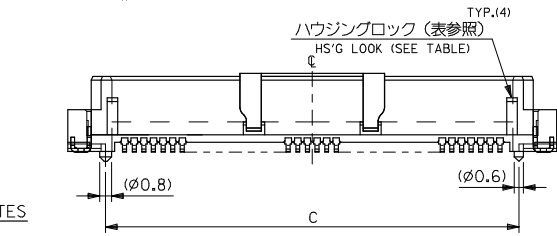
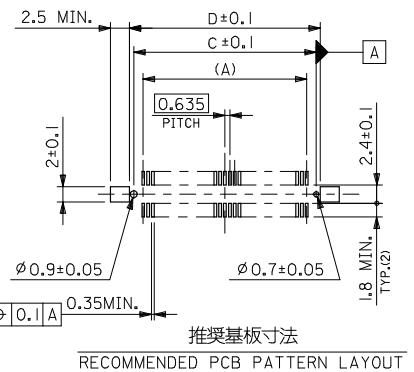
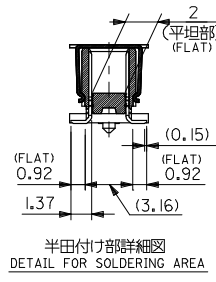
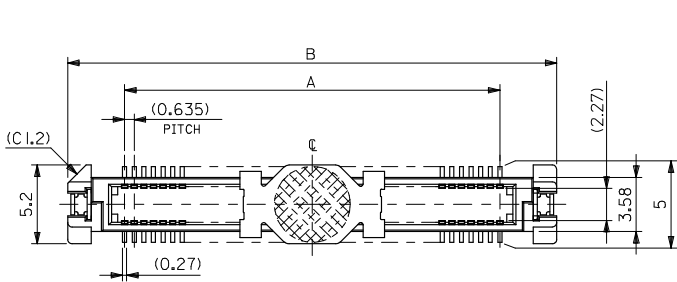

注) NOTES

- 材質 MATERIAL  
ハウジング : ガラス入りLCP、黒色、UL94V-0  
HOUSING: LIQUID CRYSTAL POLYMER (LCP), GLASS FILLED, BLACK, UL94V-0  
ターミナル : 銅合金 (t=0.2)  
TERMINAL: COPPER ALLOY  
吸着カバー : ステンレス (t=0.2)  
VACUUM COVER: STAINLESS STEEL  
補強金具 : 銅合金 (t=0.25)  
FITTING NAIL: COPPER ALLOY
- メッキ仕様 PLATING  
ターミナル : 接点部 : 金メッキ 0.25 マイクロメートル以上。  
TERMINAL CONTACT AREA : GOLD 0.25 MICROMETER MINIMUM.  
半田付け部 : 錫メッキ 1.0 マイクロメートル以上。  
SOLDER TAIL AREA : TIN 1.0 MICROMETER MINIMUM.  
下地メッキ : ニッケルメッキ 1.5 マイクロメートル以上。  
UNDER-PLATING : NICKEL 1.5 MICROMETER MINIMUM.  
補強金具 : 錫メッキ 1.0 マイクロメートル以上。  
FITTING NAIL TIN 1.0 MICROMETER MINIMUM.  
下地メッキ : ニッケルメッキ 1.0 マイクロメートル以上。  
UNDER-PLATING: NICKEL 1.0 MICROMETER MINIMUM.
- テールのバラツキ寸法 TAIL COPLANARITY  
テール及び金具の平坦度は、0.1以下とする。  
TAIL AND FITTING NAIL COPLANARITY TO BE 0.1 MAXIMUM.
- エンボス対応済みの種数については、SD-55091-007を参照下さい。  
FOR THE EMBOSSED PACKAGE PRODUCTS, SEE SD-55091-007.
- 本製品は55091-\*\*\*2の鉛フリー品である。  
THIS PRODUCT IS LEAD FREE OF 55091-\*\*\*2.

	79.17	78.07	83.07	75.565	—	55091-2475	55091-2472	240	○
無し NO	66.47	65.37	70.37	62.865	—	-2075	-2072	200	○
	60.12	59.02	64.02	56.515	—	-1875	-1872	180	○
	53.77	52.67	57.67	50.165	55091-1674	-1675	-1672	160	○
	47.42	46.32	51.32	43.815	55091-1474	-1475	-1472	140	○
	41.07	39.97	44.97	37.465	55091-1274	-1275	-1272	120	○
	34.72	33.62	38.62	31.115	55091-1074	-1075	-1072	100	○
	31.55	30.45	35.45	27.94	55091-0974	-0975	-0972	90	○
	28.37	27.27	32.27	24.765	55091-0874	-0875	-0872	80	○
	25.2	24.1	29.1	21.59	55091-0774	-0775	-0772	70	○
	24.56	23.46	28.46	20.955	—	-6875	-6872	68	○
有り YES	22.02	20.92	25.92	18.415	55091-0674	-0675	-0672	60	○
	18.85	17.75	22.75	15.24	55091-0574	-0575	-0572	50	○
	15.67	14.57	19.57	12.065	55091-0474	-0475	-0472	40	○
	12.5	11.4	16.4	8.89	55091-0374	-0375	-0372	30	○
	9.32	8.22	13.22	5.715	55091-0274	55091-0275	55091-0272	20	○

REVISED EC NO: J2009-0365 DRAWN BY: H. KAWABATA CHECKED BY: K. TOJO APPROVED BY: M. SASAO DATE: 2008/08/07 DATE: 2008/08/07 DATE: 2008/08/07	DESCRIPTION H	GENERAL TOLERANCES (UNLESS SPECIFIED)	DIMENSION STYLE MM ONLY	SCALE ---	DESIGN UNITS METRIC	THIRD ANGLE PROJECTION
		10 UNDER ± 0.2	DRAWN BY H. KAWABATA	DATE '04/03/05	TITLE 0.635 PITCH B-T-O-B PLUG HS'G COVER ASS'Y -LEAD FREE-	
		10 OVER 30 UNDER ± 0.25	CHECKED BY K. TOJO	DATE '04/03/05		
		30 OVER ± 0.3	APPROVED BY M. SASAO	DATE '04/03/05		
		ANGULAR ± 3 °	MATERIAL NO. SEE TABLE	DOCUMENT NO. SD-55091-006	SHEET NO. 1 OF 1	
		DRAFT WHERE APPLICABLE MUST REMAIN WITHIN DIMENSIONS	SIZE A3	THIS DRAWING CONTAINS INFORMATION THAT IS PROPRIETARY TO MOLEX INCORPORATED AND SHOULD NOT BE USED WITHOUT WRITTEN PERMISSION		

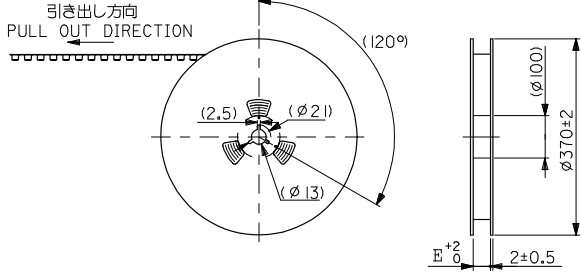

注)  
NOTES

- 製品番号 55091-\*\*\*72 の詳細寸法については、SD-55091-006 を参照下さい。  
IN THE PACKAGE, PART NO. 55901-\*\*\*72 DETAILED DIMENSIONS, SEE SD-55091-006.
- 梱包数量 : 1000 個/リール  
NUMBER OF CONNECTORS, 1000 PCS/REEL
- リードテープ長さ  
LEAD TAPE LENGTH

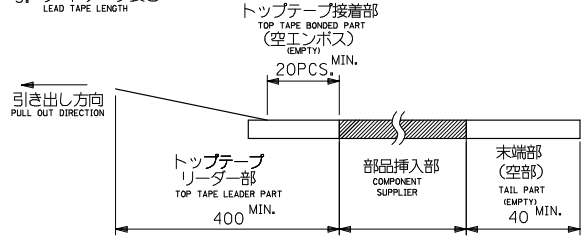

- トップテープの剥離強度: (剥離方向は下図参照)  
PEELING OFF FORCE OF TOP TAPE (PEELING DIRECTION AS SHOWN IN FOLLOWING FIG.)  
0. 1~1. 3N {10~130gf}

尚、本規格値は、出荷時に適用。  
THIS REQUIREMENT SHOULD BE APPLIED AT SHIPMENT  
(但し、輸送時に剥離が発生しない事。)  
(PEEL OFF SHOULD NOT BE ALLOWED DURING TRANSPORTATION)

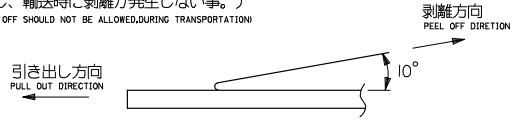

5. 材料

MATERIAL  
キャリアテープ : ポリプロピレン (PP)  
CARRIER TAPE : POLYPROPYLENE (PP)  
トップテープ : PET, PE, PEF  
TOP TAPE : PET, PE, PEF  
リール : 紙  
REEL : CARDBOARD

- 本製品は55091-\*\*\*4の鉛フリー品である。  
THIS PRODUCT IS LEAD FREE OF 55091-\*\*\*4.

MODEL NO. 55091-\*\*\*74

REVISED EC NO.: J2009-0365 DRAWN BY: CHIKO HARUYAMA CHECKED BY: APPRANKITA DATE: 2008/08/06 2008/08/07 2008/08/07	DESCRIPTION	GENERAL TOLERANCES (UNLESS SPECIFIED)		DIMENSION STYLE MM ONLY		SCALE	DESIGN UNITS	THIRD ANGLE PROJECTION		
		10 UNDER	±0.2	DRAWN BY	DATE	---	METRIC	55091-***72 TAPING PACKAGE -LEAD FREE-		
		10 OVER 30 UNDER	±0.25	KAWABATA	'04/03/05	TITLE	MOLEX INCORPORATED			
		30 OVER	±0.3	CHECKED BY	DATE	SEE SHEET 2,3				
		ANGULAR	±3 °	APPROVED BY	DATE	MATERIAL NO.	DOCUMENT NO.	SHEET NO.	INCORPORATED AND SHOULD NOT BE USED WITHOUT WRITTEN PERMISSION	
DRAFT WHERE APPLICABLE MUST REMAIN WITHIN DIMENSIONS		MSASAO	'04/03/05	SD-55091-007	1 OF 3					

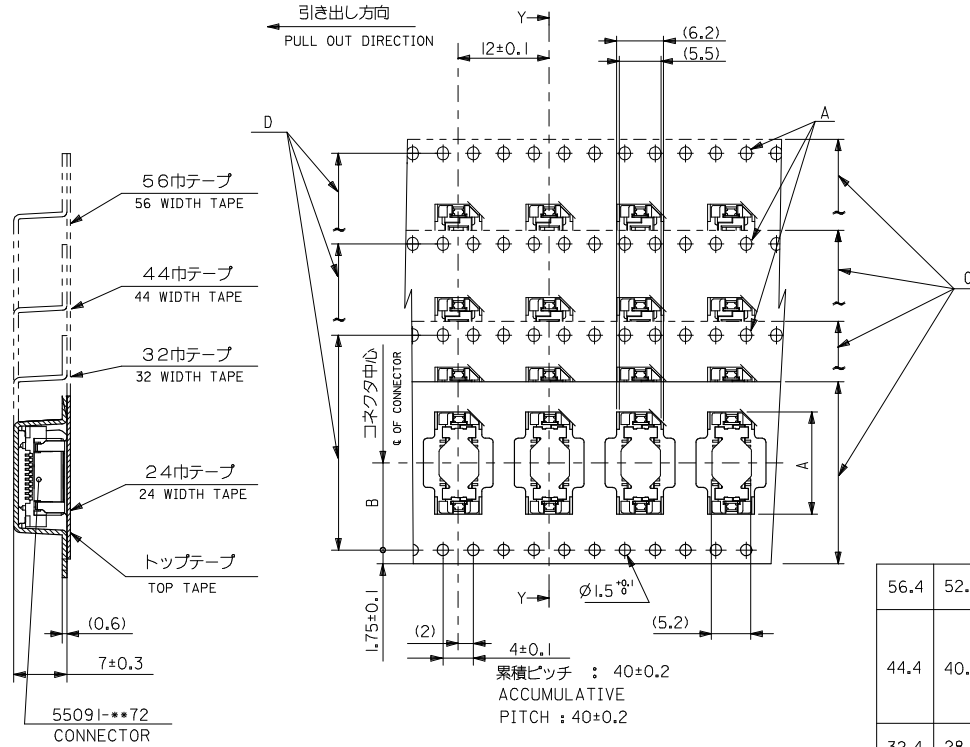

56.4	52.4	56 <sup>+0.3</sup>	26.2	38.9	55091-1074	100	○
				35.8	-0974	90	○
				32.6	-0874	80	○
				29.4	-0774	70	○
44.4	40.4	44 <sup>+0.3</sup>	20.2	28.8	-6874	68	-
				26.2	-0674	60	○
				23.1	-0574	50	○
32.4	28.4	32 <sup>+0.3</sup>	14.2	19.9	-0474	40	○
				16.7	-0374	30	○
55091-72	24.4	24 <sup>+0.3</sup>	11.5	13.5	55091-0274	20	○

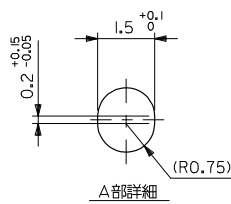

REVISED	DESCRIPTION	GENERAL TOLERANCES (UNLESS SPECIFIED)	DIMENSION STYLE	SCALE	DESIGN UNITS	THIRD ANGLE PROJECTION
EC NO: J2009-0365	2008/08/06	10 UNDER ±0.2	MM ONLY	---	METRIC	☉ □
DRAWN BY: DRUMHAGEI	2008/08/07	10 OVER 30 UNDER ±0.25	DRAWN BY: KAWABATA	DATE: '04/03/05	TITLE: 55091-72 TAPING PACKAGE -LEAD FREE-	
CHKD: HIRUYAMA	2008/08/07	30 OVER ±0.3	CHECKED BY: KTOJO	DATE: '04/03/05		
APPR: NIKITA	2008/08/07	ANGULAR ±3°	APPROVED BY: MSASAO	DATE: '04/03/05	MOLEX INCORPORATED	
		DRAFT WHERE APPLICABLE MUST REMAIN WITHIN DIMENSIONS	MATERIAL NO. SEE TABLE	DOCUMENT NO. SD-55091-007		SHEET NO. 2 OF 3
			SIZE: A3	THIS DRAWING CONTAINS INFORMATION THAT IS PROPRIETARY TO MOLEX INCORPORATED AND SHOULD NOT BE USED WITHOUT WRITTEN PERMISSION		

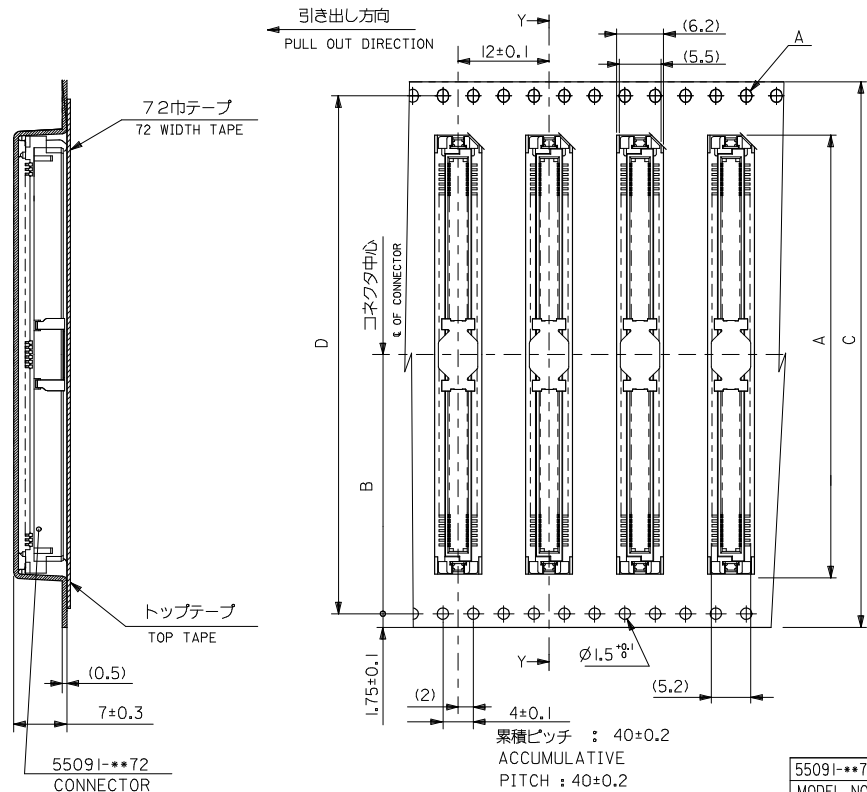

断面 Y-Y  
SECTION Y-Y

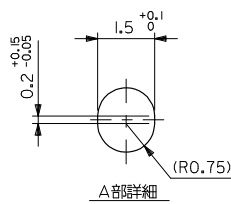

55091-**-74	72.4	68.4	72 <sup>+0.3</sup>	34.2	58.0	55091-1674	160	○
					51.6	55091-1474	140	○
					45.3	55091-1274	120	○

MODEL NO.	E	D	C	キャリアテープ幅 CARRIER TAPE WIDTH	(B)	(A)	MATERIAL NO.	種別 NO. OF OUTS.	取付可能 AVAILABLE
				72					

REVISION	DESCRIPTION	DATE	BY
REVISED	2008/08/06		
EC NO. : J2009-0365	DRW: NHABE	2008/08/07	
	CHK: THAYAMA	2008/08/07	
	APP: RINKITA	2008/08/07	

GENERAL TOLERANCES (UNLESS SPECIFIED)		DIMENSION STYLE	SCALE	DESIGN UNITS
		MM ONLY	---	METRIC
10 UNDER	± 0.2	DRAWN BY	DATE	TITLE
10 OVER	± 0.25	KAWABATA	'04/03/05	55091-**-72 TAPING PACKAGE -LEAD FREE-
30 UNDER	± 0.25	CHECKED BY	DATE	
30 OVER	± 0.3	KTOJO	'04/03/05	
ANGULAR	± 3 °	APPROVED BY	DATE	
		MSASAO	'04/03/05	
DRAFT WHERE APPLICABLE MUST REMAIN WITHIN DIMENSIONS		MATERIAL NO.	DOCUMENT NO.	SHEET NO.
		SEE TABLE	SD-55091-007	3 OF 3