

# NTD5804N, NTDV5804N, SVD5804N

## Power MOSFET

40 V, 69 A, Single N-Channel, DPAK

### Features

- Low  $R_{DS(on)}$
- High Current Capability
- Avalanche Energy Specified
- NTDV, STDV and SVD Prefix for Automotive and Other Applications Requiring Unique Site and Control Change Requirements; AEC-Q101 Qualified and PPAP Capable
- These Devices are Pb-Free and are RoHS Compliant

### Applications

- CCFL Backlight
- DC Motor Control
- Class D Amplifier
- Power Supply Secondary Side Synchronous Rectification

### MAXIMUM RATINGS ( $T_J = 25^\circ\text{C}$ unless otherwise noted)

Parameter		Symbol	Value	Unit	
Drain-to-Source Voltage		$V_{DSS}$	40	V	
Gate-to-Source Voltage – Continuous		$V_{GS}$	$\pm 20$	V	
Gate-to-Source Voltage – Non-Repetitive ( $t_p < 10 \mu\text{s}$ )		$V_{GS}$	$\pm 30$	V	
Continuous Drain Current ( $R_{\theta JC}$ ) (Note 1)	Steady State	$T_C = 25^\circ\text{C}$	$I_D$	69	A
		$T_C = 100^\circ\text{C}$		49	
		$T_C = 25^\circ\text{C}$	$P_D$	71	W
Pulsed Drain Current		$t_p = 10 \mu\text{s}$	$I_{DM}$	125	A
Operating Junction and Storage Temperature		$T_J, T_{stg}$	-55 to 175	$^\circ\text{C}$	
Source Current (Body Diode)		$I_S$	60	A	
Single Pulse Drain-to-Source Avalanche Energy ( $V_{DD} = 50 \text{ V}$ , $V_{GS} = 10 \text{ V}$ , $R_G = 25 \Omega$ , $I_{L(pk)} = 36 \text{ A}$ , $L = 0.3 \text{ mH}$ , $V_{DS} = 40 \text{ V}$ )		$E_{AS}$	195	mJ	
Lead Temperature for Soldering Purposes (1/8" from case for 10 s)		$T_L$	260	$^\circ\text{C}$	

Stresses exceeding those listed in the Maximum Ratings table may damage the device. If any of these limits are exceeded, device functionality should not be assumed, damage may occur and reliability may be affected.

### THERMAL RESISTANCE MAXIMUM RATINGS

Parameter	Symbol	Value	Unit
Junction-to-Case (Drain)	$R_{\theta JC}$	2.1	$^\circ\text{C/W}$
Junction-to-Ambient – Steady State (Note 1)	$R_{\theta JA}$	106	

1. Surface-mounted on FR4 board using the minimum recommended pad size.



ON Semiconductor®

[www.onsemi.com](http://www.onsemi.com)

$V_{(BR)DSS}$	$R_{DS(on)}$ MAX	$I_D$ MAX
40 V	12 m $\Omega$ @ 5.0 V	69 A
	7.5 m $\Omega$ @ 10 V	

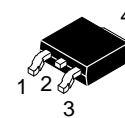
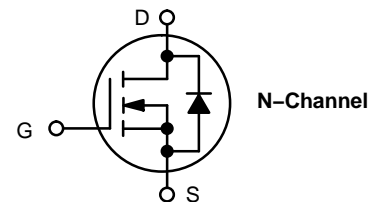

**DPAK  
CASE 369C  
(Surface Mount)  
STYLE 2**

### MARKING DIAGRAM & PIN ASSIGNMENT

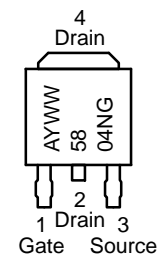

A = Assembly Location\*  
 Y = Year  
 WW = Work Week  
 5804N = Device Code  
 G = Pb-Free Package

\* The Assembly Location code (A) is front side optional. In cases where the Assembly Location is stamped in the package, the front side assembly code may be blank.

### ORDERING INFORMATION

See detailed ordering and shipping information in the package dimensions section on page 5 of this data sheet.

# NTD5804N, NTDV5804N, SVD5804N

## ELECTRICAL CHARACTERISTICS (T<sub>J</sub> = 25°C unless otherwise noted)

Parameter	Symbol	Test Condition	Min	Typ	Max	Unit
-----------	--------	----------------	-----	-----	-----	------

### OFF CHARACTERISTICS

Drain-to-Source Breakdown Voltage	V <sub>(BR)DSS</sub>	V <sub>GS</sub> = 0 V, I <sub>D</sub> = 250 μA	40	45		V
Drain-to-Source Breakdown Voltage Temperature Coefficient	V <sub>(BR)DSS</sub> /T <sub>J</sub>			41		mV/°C
Zero Gate Voltage Drain Current	I <sub>DSS</sub>	V <sub>GS</sub> = 0 V, V <sub>DS</sub> = 40 V	T <sub>J</sub> = 25°C		1.0	μA
			T <sub>J</sub> = 150°C		100	
Gate-to-Source Leakage Current	I <sub>GSS</sub>	V <sub>DS</sub> = 0 V, V <sub>GS</sub> = ±20 V			±100	nA

### ON CHARACTERISTICS (Note 2)

Gate Threshold Voltage	V <sub>GS(TH)</sub>	V <sub>GS</sub> = V <sub>DS</sub> , I <sub>D</sub> = 250 μA	2.0		3.5	V
Negative Threshold Temperature Coefficient	V <sub>GS(TH)</sub> /T <sub>J</sub>			7.3		mV/°C
Drain-to-Source On Resistance	R <sub>DS(on)</sub>	V <sub>GS</sub> = 10 V, I <sub>D</sub> = 30 A		5.7	7.5	mΩ
		V <sub>GS</sub> = 5 V, I <sub>D</sub> = 10 A		7.9	12	
Forward Transconductance	g <sub>FS</sub>	V <sub>DS</sub> = 15 V, I <sub>D</sub> = 15 A		12		S

### CHARGES, CAPACITANCES AND GATE RESISTANCES

Input Capacitance	C <sub>iss</sub>	V <sub>GS</sub> = 0 V, f = 1.0 MHz, V <sub>DS</sub> = 25 V		2460	2850	pF
Output Capacitance	C <sub>oss</sub>			310	400	
Reverse Transfer Capacitance	C <sub>riss</sub>			215	280	
Total Gate Charge	Q <sub>G(TOT)</sub>	V <sub>GS</sub> = 10 V, V <sub>DS</sub> = 32 V, I <sub>D</sub> = 30 A		45		nC
Threshold Gate Charge	Q <sub>G(TH)</sub>			2.8		
Gate-to-Source Charge	Q <sub>GS</sub>			10		
Gate-to-Drain Charge	Q <sub>GD</sub>			12.6		

### SWITCHING CHARACTERISTICS (Note 3)

Turn-On Delay Time	t <sub>d(on)</sub>	V <sub>GS</sub> = 10 V, V <sub>DD</sub> = 32 V, I <sub>D</sub> = 30 A, R <sub>G</sub> = 2.5 Ω		11.8		ns
Rise Time	t <sub>r</sub>			18.7		
Turn-Off Delay Time	t <sub>d(off)</sub>			26.8		
Fall Time	t <sub>f</sub>			5.9		

### DRAIN-SOURCE DIODE CHARACTERISTICS

Forward Diode Voltage	V <sub>SD</sub>	V <sub>GS</sub> = 0 V, I <sub>S</sub> = 10 A	T <sub>J</sub> = 25°C		0.81	1.2	V
			T <sub>J</sub> = 150°C		0.63		
Reverse Recovery Time	t <sub>RR</sub>	V <sub>GS</sub> = 0 V, dI <sub>S</sub> /dt = 100 A/μs, I <sub>S</sub> = 30 A		21.7		ns	
Charge Time	t <sub>a</sub>			11.9			
Discharge Time	t <sub>b</sub>			9.8			
Reverse Recovery Charge	Q <sub>RR</sub>			11.8			nC

Product parametric performance is indicated in the Electrical Characteristics for the listed test conditions, unless otherwise noted. Product performance may not be indicated by the Electrical Characteristics if operated under different conditions.

2. Pulse Test: Pulse Width ≤ 300 μs, Duty Cycle ≤ 2%.
3. Switching characteristics are independent of operating junction temperatures.

TYPICAL PERFORMANCE CHARACTERISTICS

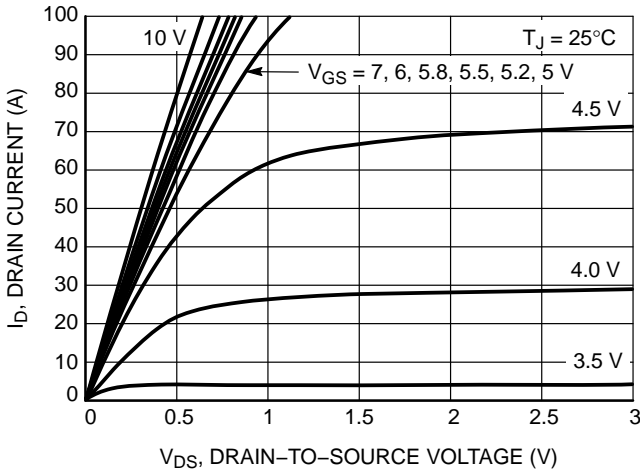

Figure 1. On-Region Characteristics

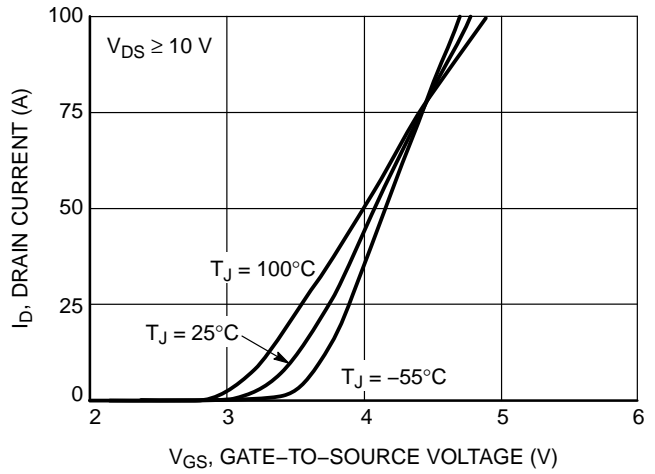

Figure 2. Transfer Characteristics

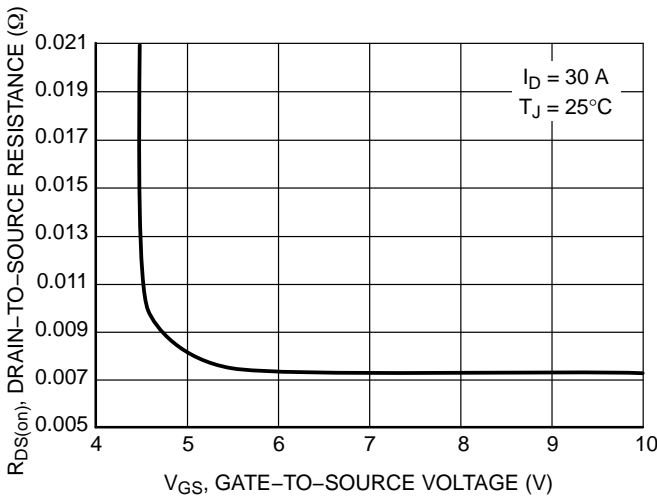

Figure 3. On-Resistance vs. Drain Current

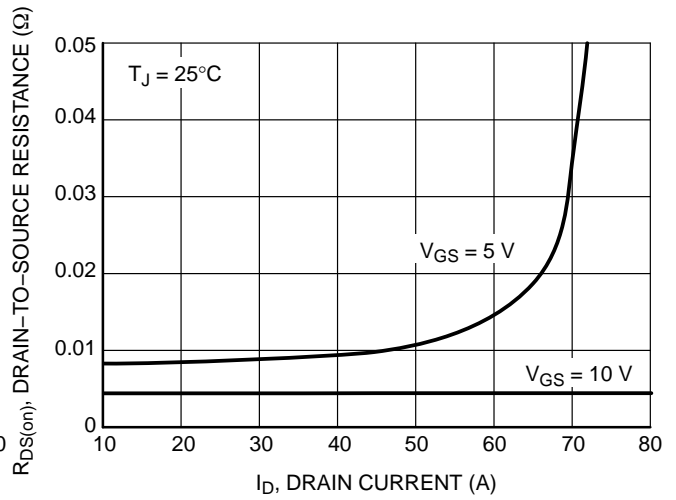

Figure 4. On-Resistance vs. Drain Current and Gate Voltage

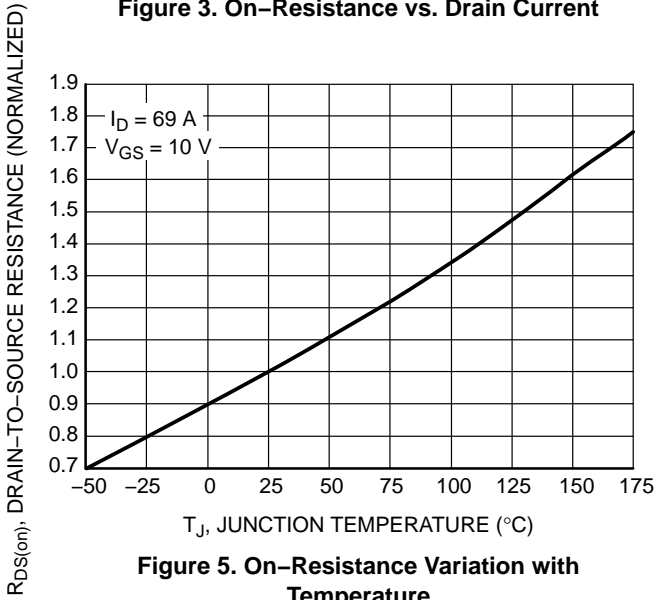

Figure 5. On-Resistance Variation with Temperature

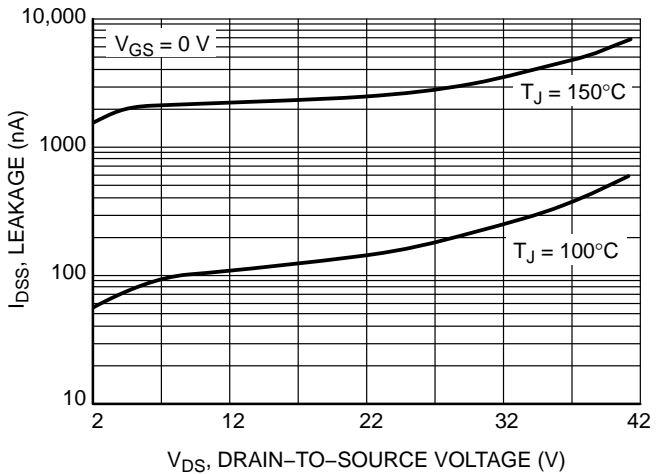
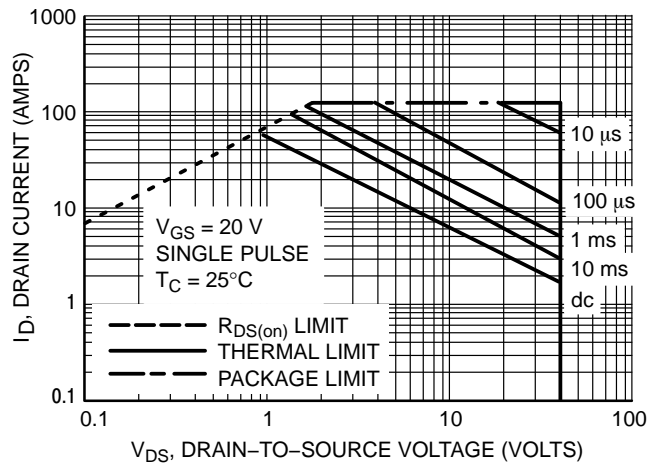
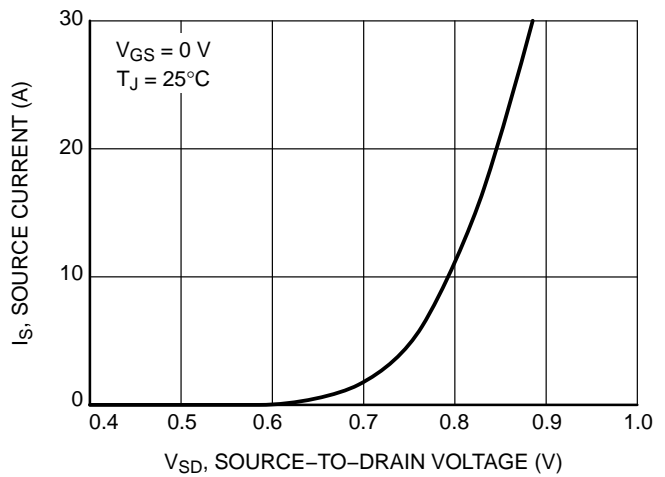
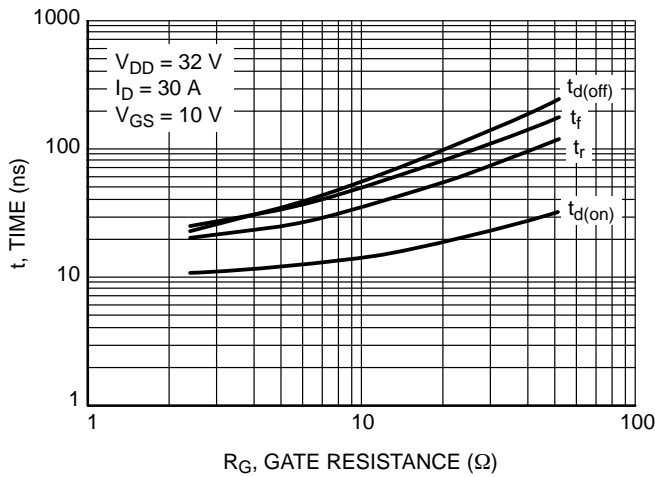
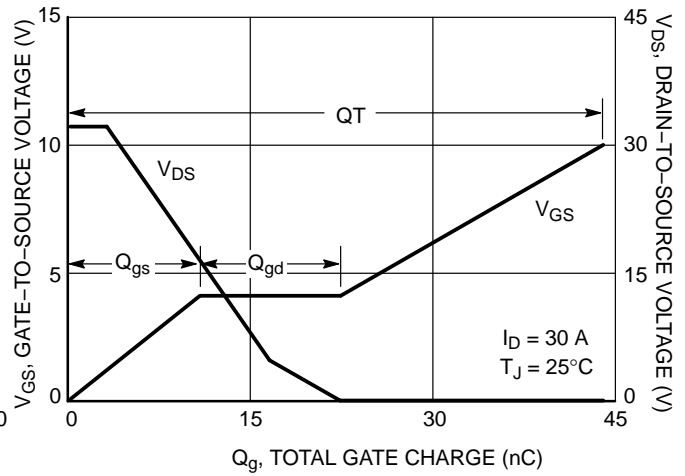
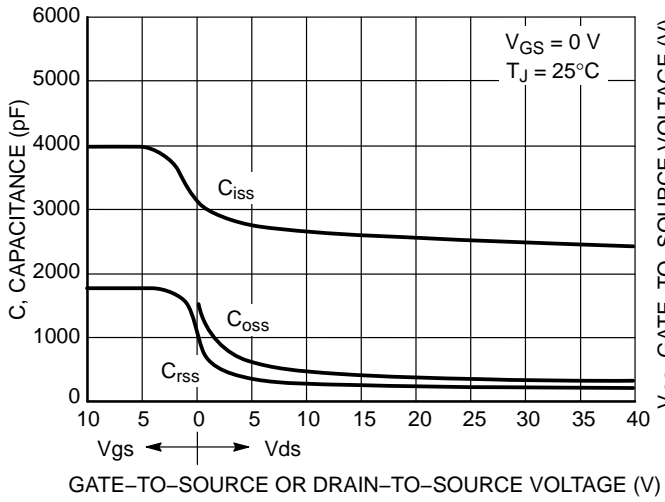

Figure 6. Drain-to-Source Leakage Current vs. Voltage

# NTD5804N, NTDV5804N, SVD5804N

## TYPICAL PERFORMANCE CHARACTERISTICS



# NTD5804N, NTDV5804N, SVD5804N

## TYPICAL PERFORMANCE CHARACTERISTICS

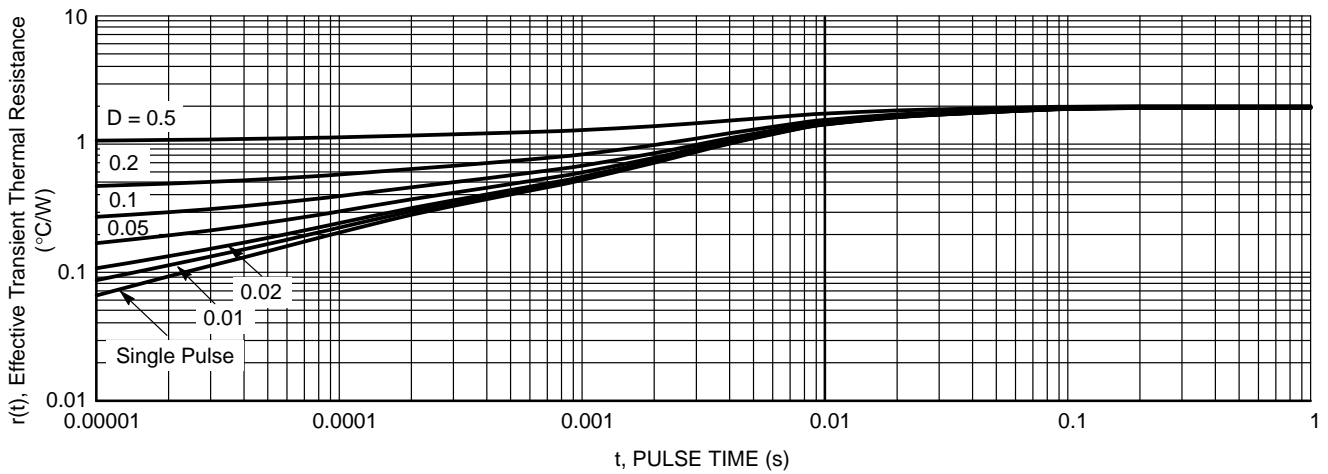

**Figure 12. Thermal Response**

### ORDERING INFORMATION

Order Number	Package	Shipping <sup>†</sup>
NTD5804NT4G	DPAK (Pb-Free)	2500 / Tape & Reel
NTDV5804NT4G*	DPAK (Pb-Free)	2500 / Tape & Reel
STDV5804NT4G*	DPAK (Pb-Free)	2500 / Tape & Reel
SVD5804NT4G*	DPAK (Pb-Free)	2500 / Tape & Reel

<sup>†</sup>For information on tape and reel specifications, including part orientation and tape sizes, please refer to our Tape and Reel Packaging Specifications Brochure, BRD8011/D.

\*NTDV, STDV and SVD Prefix for Automotive and Other Applications Requiring Unique Site and Control Change Requirements; AEC-Q101 Qualified and PPAP Capable.

# NTD5804N, NTDV5804N, SVD5804N

## PACKAGE DIMENSIONS

### DPAK (SINGLE GAUGE) CASE 369C ISSUE E

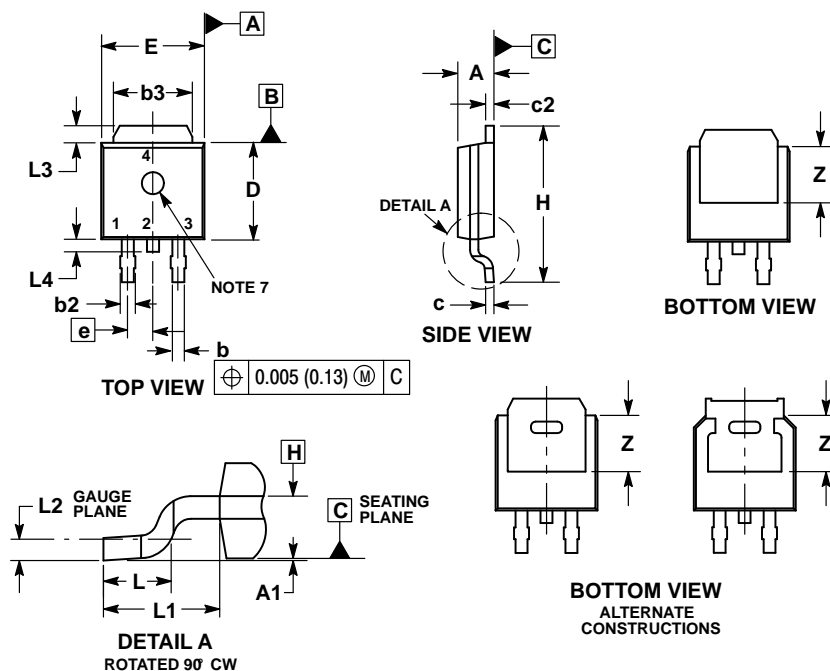

#### NOTES:

1. DIMENSIONING AND TOLERANCING PER ASME Y14.5M, 1994.
2. CONTROLLING DIMENSION: INCHES.
3. THERMAL PAD CONTOUR OPTIONAL WITHIN DIMENSIONS b3, L3 and Z.
4. DIMENSIONS D AND E DO NOT INCLUDE MOLD FLASH, PROTRUSIONS, OR BURRS. MOLD FLASH, PROTRUSIONS, OR GATE BURRS SHALL NOT EXCEED 0.006 INCHES PER SIDE.
5. DIMENSIONS D AND E ARE DETERMINED AT THE OUTERMOST EXTREMES OF THE PLASTIC BODY.
6. DATUMS A AND B ARE DETERMINED AT DATUM PLANE H.
7. OPTIONAL MOLD FEATURE.

DIM	INCHES		MILLIMETERS	
	MIN	MAX	MIN	MAX
A	0.086	0.094	2.18	2.38
A1	0.000	0.005	0.00	0.13
b	0.025	0.035	0.63	0.89
b2	0.028	0.045	0.72	1.14
b3	0.180	0.215	4.57	5.46
c	0.018	0.024	0.46	0.61
c2	0.018	0.024	0.46	0.61
D	0.235	0.245	5.97	6.22
E	0.250	0.265	6.35	6.73
e	0.090	BSC	2.29	BSC
H	0.370	0.410	9.40	10.41
L	0.055	0.070	1.40	1.78
L1	0.114	REF	2.90	REF
L2	0.020	BSC	0.51	BSC
L3	0.035	0.050	0.89	1.27
L4	---	0.040	---	1.01
Z	0.155	---	3.93	---

#### STYLE 2:

1. GATE
2. DRAIN
3. SOURCE
4. DRAIN

#### SOLDERING FOOTPRINT\*

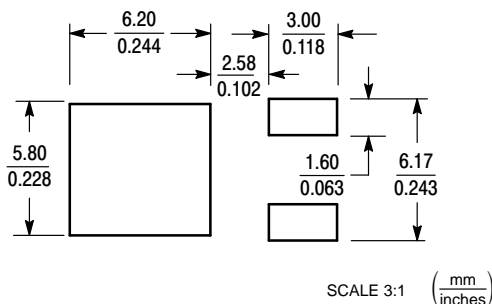

\*For additional information on our Pb-Free strategy and soldering details, please download the ON Semiconductor Soldering and Mounting Techniques Reference Manual, SOLDERRM/D.

ON Semiconductor and are trademarks of Semiconductor Components Industries, LLC dba ON Semiconductor or its subsidiaries in the United States and/or other countries. ON Semiconductor owns the rights to a number of patents, trademarks, copyrights, trade secrets, and other intellectual property. A listing of ON Semiconductor's product/patent coverage may be accessed at [www.onsemi.com/site/pdf/Patent-Marking.pdf](http://www.onsemi.com/site/pdf/Patent-Marking.pdf). ON Semiconductor reserves the right to make changes without further notice to any products herein. ON Semiconductor makes no warranty, representation or guarantee regarding the suitability of its products for any particular purpose, nor does ON Semiconductor assume any liability arising out of the application or use of any product or circuit, and specifically disclaims any and all liability, including without limitation special, consequential or incidental damages. Buyer is responsible for its products and applications using ON Semiconductor products, including compliance with all laws, regulations and safety requirements or standards, regardless of any support or applications information provided by ON Semiconductor. "Typical" parameters which may be provided in ON Semiconductor data sheets and/or specifications can and do vary in different applications and actual performance may vary over time. All operating parameters, including "Typicals" must be validated for each customer application by customer's technical experts. ON Semiconductor does not convey any license under its patent rights nor the rights of others. ON Semiconductor products are not designed, intended, or authorized for use as a critical component in life support systems or any FDA Class 3 medical devices or medical devices with a same or similar classification in a foreign jurisdiction or any devices intended for implantation in the human body. Should Buyer purchase or use ON Semiconductor products for any such unintended or unauthorized application, Buyer shall indemnify and hold ON Semiconductor and its officers, employees, subsidiaries, affiliates, and distributors harmless against all claims, costs, damages, and expenses, and reasonable attorney fees arising out of, directly or indirectly, any claim of personal injury or death associated with such unintended or unauthorized use, even if such claim alleges that ON Semiconductor was negligent regarding the design or manufacture of the part. ON Semiconductor is an Equal Opportunity/Affirmative Action Employer. This literature is subject to all applicable copyright laws and is not for resale in any manner.

#### PUBLICATION ORDERING INFORMATION

##### LITERATURE FULFILLMENT:

Literature Distribution Center for ON Semiconductor  
19521 E. 32nd Pkwy, Aurora, Colorado 80011 USA  
Phone: 303-675-2175 or 800-344-3860 Toll Free USA/Canada  
Fax: 303-675-2176 or 800-344-3867 Toll Free USA/Canada  
Email: [orderlit@onsemi.com](mailto:orderlit@onsemi.com)

N. American Technical Support: 800-282-9855 Toll Free  
USA/Canada  
Europe, Middle East and Africa Technical Support:  
Phone: 421 33 790 2910  
Japan Customer Focus Center  
Phone: 81-3-5817-1050

ON Semiconductor Website: [www.onsemi.com](http://www.onsemi.com)

Order Literature: <http://www.onsemi.com/orderlit>

For additional information, please contact your local Sales Representative