

Excellent Integrated System Limited

Stocking Distributor

Click to view price, real time Inventory, Delivery & Lifecycle Information:

[Molex Connector Corporation](#)
[0003091033](#)

For any questions, you can email us directly:

sales@integrated-circuit.com

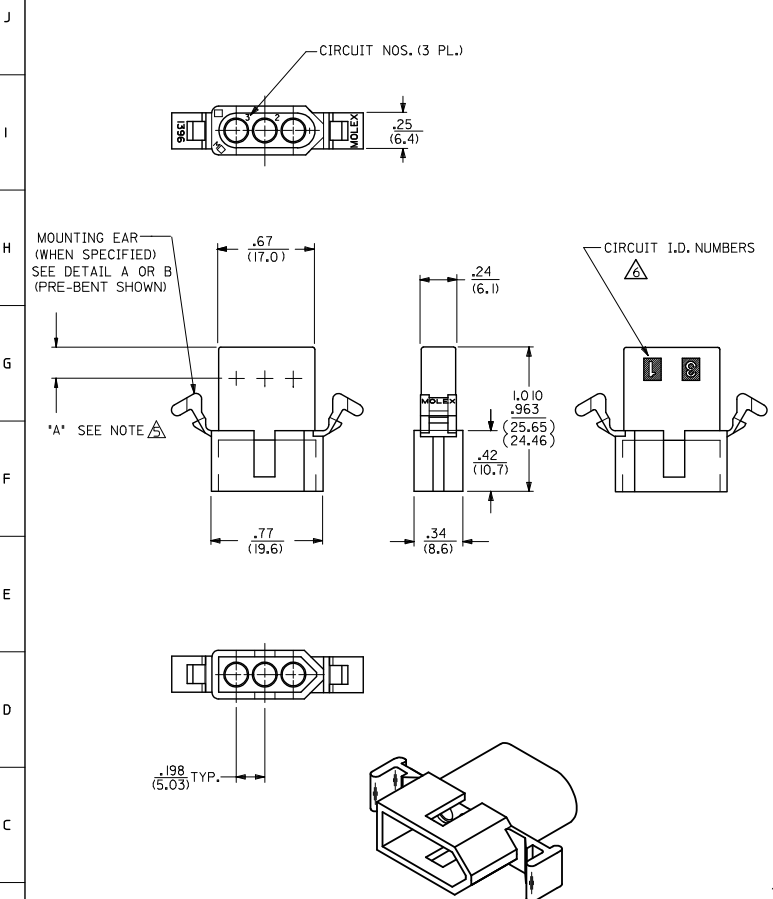

PLUG

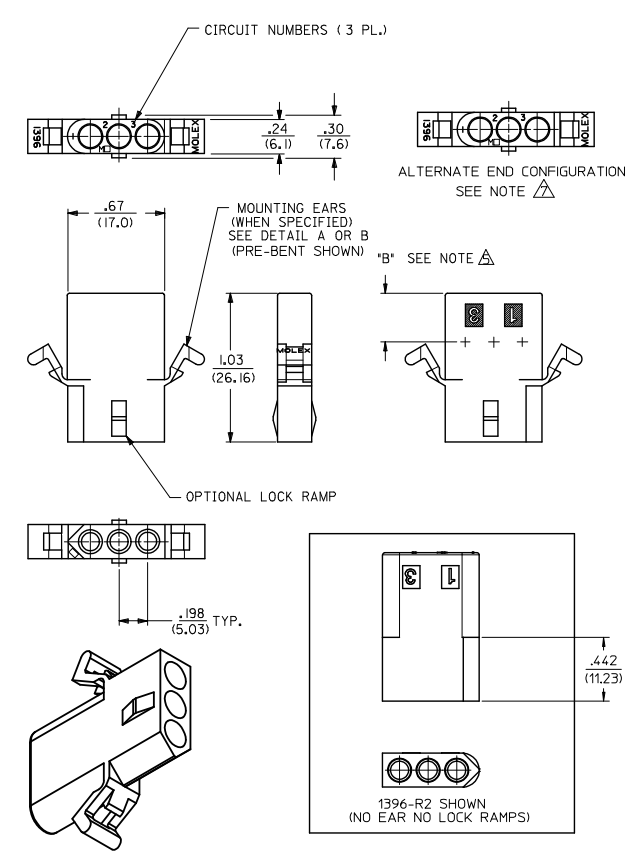

RECEPTACLE

ADD PK-1396-002 EC NO: UCP2016-2183 DRAWN: KIPPER 2015/12/09 CHKD: BELL 2015/12/09 APPR: SMITH 2015/12/23	QUALITY SYMBOLS ▽=0 ▽=0 ▽=0	GENERAL TOLERANCES (UNLESS SPECIFIED)		DIMENSION STYLE		SCALE	DESIGN UNITS	THIRD ANGLE PROJECTION		
		mm	INCH	IN/MM		2:1	INCH	INCH		
REV Z3	4 PLACES	±	---	DATE	TITLE					
	3 PLACES	±	---	1988/04/08	.093/(2.36) HOUSING					
	2 PLACES	±	0.25	±	0.010	PLUG AND RECEPTACLE				
	1 PLACE	±	0.35	±	---	3 CIRCUIT .198 CENTERS				
0 PLACE	±	---	±	---	molex					
ANGULAR ±1/2°		MATERIAL NO.		DOCUMENT NO.		SHEET NO.		1 OF 2		
DRAFT WHERE APPLICABLE MUST REMAIN WITHIN DIMENSIONS		SEE CHART		SD-1396-*						
THIS DRAWING CONTAINS INFORMATION THAT IS PROPRIETARY TO MOLEX INCORPORATED AND SHOULD NOT BE USED WITHOUT WRITTEN PERMISSION										

PLUG		RECEPTACLE	
ORDER NO.	ENG. NO.	ORDER NO.	ENG. NO.
03-09-2031	I396-P	03-09-1031	I396-R
03-09-2032	I396-PI	03-09-1032	I396-R1
03-09-7032	I396-PIBK	03-09-1033	I396-R2
03-09-7031	I396-PBK	03-09-6033	I396-R2BK
03-09-2037	I396-P3	03-09-6032	I396-R1BK
		03-09-6031	I396-RBK
		03-09-1081	I396-R4

HOUSING	DIM. 'A'	DIM. 'B'	'C' PREBENT EAR	'C' STANDARD EAR
PLUG	.933/(23.70)	.375/(9.53)	.40/(10.2)	.38/(9.7)
RECEPT.	.830/(21.08)	.312/(7.92)	.41/(10.4)	.39/(9.9)

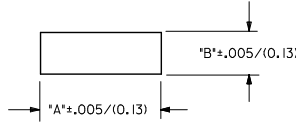
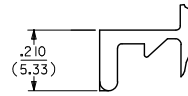
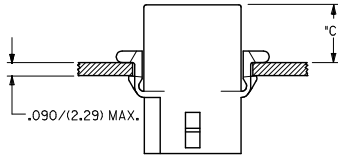

RECOMMENDED PANEL MOUNTING HOLE

DETAIL A
STANDARD MOUNTING EAR
(SCALE 4:1)

LEGEND:

I396-****-*

P = PLUG
R = RECEPTACLE

BLANK = WITH STANDARD EARS

- 1 = WITHOUT EARS
- 2 = RECEPTACLE WITHOUT EARS, WITHOUT LOCK RAMPS
- 3 = PLUG ONLY, W/ SIDE MOUNT (SEE SD-I396-P3)
- 4 = WITH PREBENT EARS

COLOR: BLANK=NATURAL COLOR

AM=AMBER BK=BLACK BU=BLUE
BN=BROWN GY=GRAY GN=GREEN
OR=ORANGE RD=RED YW=YELLOW

BLANK = NYLON 6/6, 94V-2

NOTES:

1. MATERIAL: SEE LEGEND
2. FINISH: NOT APPLICABLE
3. PRODUCT SPECIFICATION: PS-02-09
4. PACKAGING INFORMATION: REFER TO PK-1396-002
- △ DIMENSION FROM THE BACK OF THE HOUSING TO THE END OF BRUSH ON WIRE INSERTED INTO THE HOUSING:
DIM 'A' = .256/6.50 FOR 42477 & 42478 TERMINALS
.216/5.49 FOR ALL OTHER .093 TERMINALS
DIM 'B' = .377/9.58 FOR 42477 & 42478 TERMINALS
.337/8.56 FOR ALL OTHER .093 TERMINALS
- △ CIRCUIT I.D. NUMBERS ON SIDE OF HOUSING APPEAR ON PARTS FROM TOOLS BUILT AFTER 5/4/93.
- △ END CONFIGURATION IS DEPENDENT ON MOLD DESIGN. PARTS MAY HAVE EITHER CONFIGURATION.
8. PARTS CONFORM TO CLASS B REQUIREMENTS OF COSMETIC SPECIFICATION PS-45499-002.

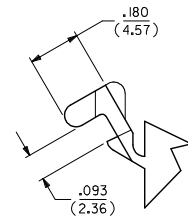

DETAIL B
PREBENT MOUNTING EAR
(SCALE 4:1)

REV	DESCRIPTION	QUALITY SYMBOLS	GENERAL TOLERANCES (UNLESS SPECIFIED)		DIMENSION STYLE		SCALE	DESIGN UNITS	THIRD ANGLE PROJECTION
			mm	INCH	IN/MM	DATE			
4	PLACES	±	---	±	---	DRAWN BY	JJS	1988/04/08	.093/(2.36) HOUSING PLUG AND RECEPTACLE 3 CIRCUIT .198 CENTERS molex SD-1396-*
3	PLACES	±	---	±	.010	CHECKED BY	DATE		
2	PLACES	±	0.25	±	.014	APPROVED BY	1988/04/08		
1	PLACE	±	0.35	±	---	DATE	2014/06/23		
0	PLACE	±	---	±	---	MATERIAL NO.	DOCUMENT NO.		
SEE SHEET 1			ANGULAR ±1/2°		MATERIAL NO.		DOCUMENT NO.		SHEET NO.
REV 1			DRAFT WHERE APPLICABLE MUST REMAIN WITHIN DIMENSIONS		SEE CHART		SD-1396-*		2 OF 2
THIS DRAWING CONTAINS INFORMATION THAT IS PROPRIETARY TO MOLEX INCORPORATED AND SHOULD NOT BE USED WITHOUT WRITTEN PERMISSION									

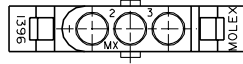
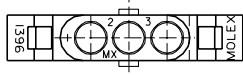

OPTIONAL END CONFIGURATION

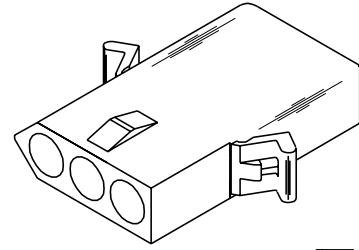

RECEPTACLE

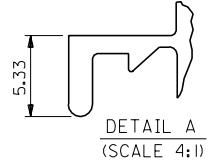

DETAIL A (SCALE 4:1)

MT'G EARS (表参照)
参照 DETAIL A OR B

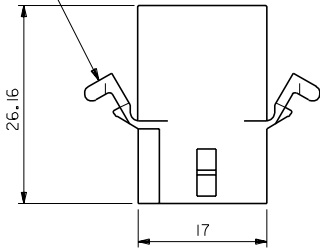

LOCKING TAB (表参照)

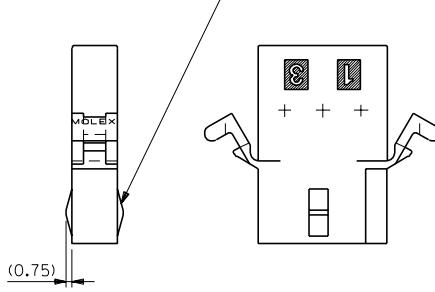

DETAIL B (SCALE 4:1)

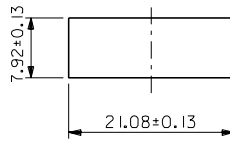
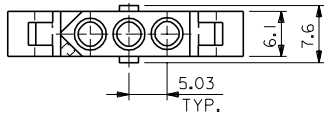

パネル取付穴寸法
(パネル厚 2.29最大)

I396R4	03-09-1081	有	WITH	有 WITH DETAIL B
I396R2	03-09-1033	無	WITHOUT	無 WITHOUT
I396R1	03-09-1032	有	WITH	無 WITHOUT
I396R	03-09-1031	有	WITH	有 WITH DETAIL A
ENG. NO.	EDP NO.	LOCKING TABS	MT'G EARS	

MODEL NO.	03-09-1***	DIMENSIONS:	SHT	REV
		THIRD ANGLE PROJECTION	mm ONLY	REVISE ON CAD ONLY

EC NO.	DRWN:	CHK:	APPR:
EC NO.	DRWN:	CHK:	APPR:
EC NO.	DRWN:	CHK:	APPR:
EC NO.	DRWN:	CHK:	APPR:
EC NO.	DRWN:	CHK:	APPR:
EC NO.	DRWN:	CHK:	APPR:
EC NO.	DRWN:	CHK:	APPR:
EC NO.	DRWN:	CHK:	APPR:
EC NO.	DRWN:	CHK:	APPR:
EC NO.	DRWN:	CHK:	APPR:
EC NO.	DRWN:	CHK:	APPR:

RELEASED	JC2001-0078
DRWN:	K.KOHAMA 00/08/28
CHK:	T.YAMAGUCHI
APPR:	M.FUKUSHIMA
DESCRIPTION	
MATERIAL	NYLON66
	94V-2
FINISH	仕上げ
WIRE RANGE	適用電線範囲
INS. RANGE	被覆外径

GENERAL TOLERANCES: (UNLESS SPECIFIED)	SCALE	DESIGN UNITS
10 UNDER 未満	2:1	mm INCH
10 OVER 以上		
30 UNDER 未満		
30 OVER 以上		
ANGLE 角度		

DRAWN BY & DATE	TITLE:
K.KOHAMA 00/08/28	3 CIRCUITS RCPT HSG
CHECKED BY & DATE	(0.093 DIA TERMINAL)
T.YAMAGUCHI 00/08/28	
APPROVED BY & DATE	
M.FUKUSHIMA 00/08/28	
CAD FILENAME	MATERIAL NO.
I396001.S01	SEE NOTES

MOLEX INCORPORATED	
DRAWING NO.	SHEET NO.
SD-1396-001	1 OF 1
THIS DRAWING CONTAINS INFORMATION THAT IS PROPRIETARY TO MOLEX INCORPORATED AND SHOULD NOT BE USED WITHOUT WRITTEN PERMISSION.	
SIZE	
B	

DO NOT SCALE DRAWING