

Excellent Integrated System Limited

Stocking Distributor

Click to view price, real time Inventory, Delivery & Lifecycle Information:

[Molex Connector Corporation](#)
[0009017095](#)

For any questions, you can email us directly:

sales@integrated-circuit.com

NOTES:

1. MATERIAL: NYLON 6/6, 94V-2.
2. FINISH: SEE CRIMP TERMINAL DRAWING.
3. THIS PRODUCT CONFORMS TO PRODUCT SPECIFICATION PS-08-50.
4. PACKAGING: BULK PER PK-2574-001
5. CONNECTOR TO BE USED WITH CRIMP TERMINALS:
2478: 18-24 GAGE WIRE, .110(1.279) MAX. INSULATION DIAMETER.
2578: 22-26 GAGE WIRE, .065(1.65) MAX. INSULATION DIAMETER.
2878: 18-20 GAGE WIRE, .110(1.279) MAX. INSULATION DIAMETER.
6. DIMENSIONS GIVEN ACROSS CENTERLINES ARE SYMMETRICAL ABOUT THOSE CENTERLINES WITHIN ONE HALF THE TOTAL TOLERANCE.
7. CIRCUIT 1 I.D. PRESENT ON ALL PARTS. LAST CIRCUIT I.D. MAY OR MAY NOT BE PRESENT.
8. PART CONFORMS TO CLASS B REQUIREMENTS OF COSMETIC SPECIFICATION PS-45499-002
9. SLOTS MAY OR MAY NOT BE PRESENT ON PART.

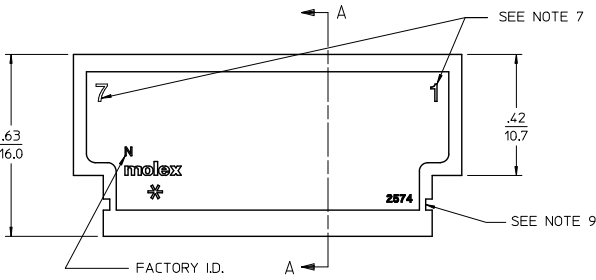
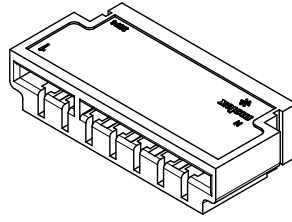
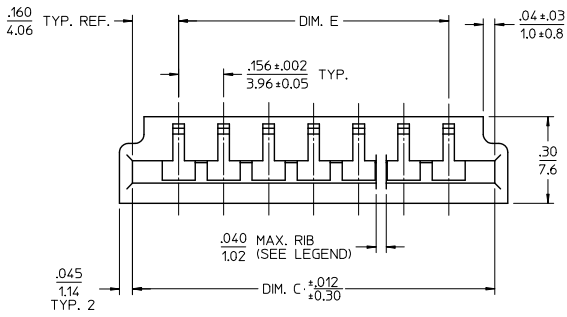

SECTION A-A

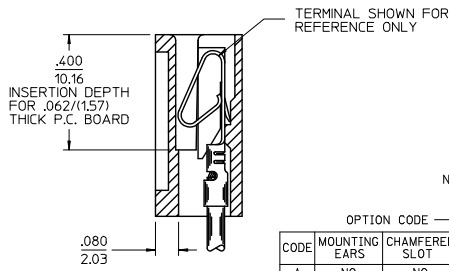

CODE	MOUNTING EARS	CHAMFERED SLOT	PCB THK	MOUNTING HOLES
A	NO	NO	.062	NO
B	YES	NO	.062	NO
C	NO	YES	.062	NO
D	YES	YES	.062	NO
E	NO	NO	.032	NO
F	YES	NO	.062	YES

2574 - N * * *
NO. OF CIRCUITS

COLOR CODE
BLANK=NATURAL
BK=BLACK

RIB LOCATION CODE (BETWEEN CKTS)
1 = NONE
2 = 2-3
3 = 3-4
4 = 5-6
5 = 3-4, 5-6
6 = 4-5, 7-8
7 = 5-6, 8-9
8 = 5-6, 10-11
9 = 4-5, 7-8, 11-12
10 = 5-6, 10-11, 14-15
11 = 5-6, 10-11, 15-16
12 = 5-6, 11-12, 16-17
13 = 5-6, 11-12, 17-18
14 = 4-5, 7-8, 11-12, 15-16
15 = 4-5, 8-9, 12-13, 16-17, 20-21
16 = 5-6, 11-12, 18-19

3 CIRCUIT ONLY

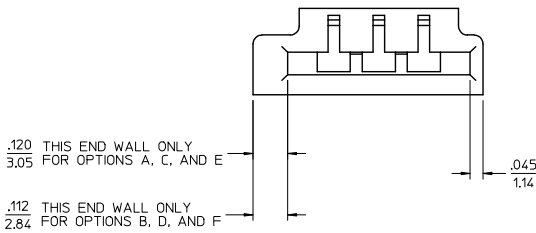

NOTE 7 EC NO: UCP2015-0556 2014/08/07 DRAWN: JIROX 2014/08/08 CHKD: KIPPER 2014/08/29 APPROVED: SMITH	QUALITY SYMBOLS	GENERAL TOLERANCES (UNLESS SPECIFIED)	DIMENSION STYLE IN/MM	SCALE 4:1	DESIGN UNITS INCH	THIRD ANGLE PROJECTION
	DESCRIPTION	4 PLACES ± .010	DRAWN BY PEREZ-ARGUET	DATE 1988/03/02	TITLE	
	REV	3 PLACES ± .010	CHECKED BY	DATE	EDGE CARD CONNECTOR	
		2 PLACES ± 0.25 ± .015	PATEL	1988/03/02	.156(3.96) CENTERS	
	1 PLACE ± 0.36 ± .015	1 PLACE ± .036 ± .015	APPROVED BY	DATE	CRIMP TYPE-2574 SERIES	
	0 PLACE ± .036 ± .015	0 PLACE ± .036 ± .015	FSMITH	2012/08/13	molex	
		ANGULAR ± 3°	MATERIAL NO.	DOCUMENT NO.	SD-2574	
		DRAFT WHERE APPLICABLE MUST REMAIN WITHIN DIMENSIONS	SEE CHART		SHEET NO. 1 OF 3	
			SIZE C	THIS DRAWING CONTAINS INFORMATION THAT IS PROPRIETARY TO MOLEX INCORPORATED AND SHOULD NOT BE USED WITHOUT WRITTEN PERMISSION		

13 12 11 10 9 8 7 6 5 4 3 2 1

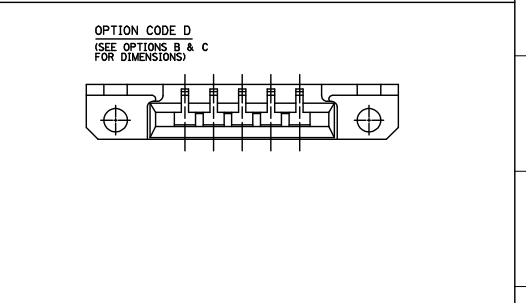
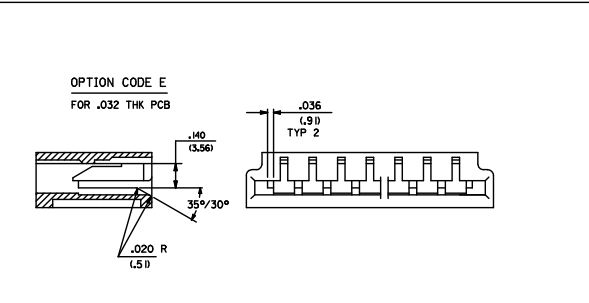
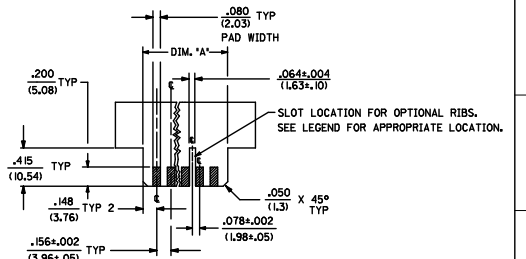
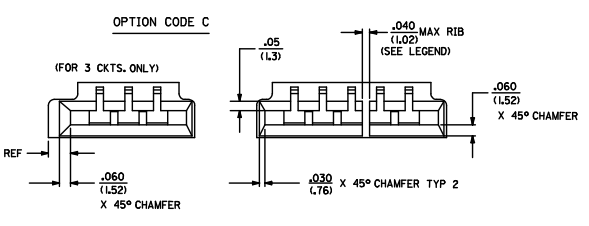
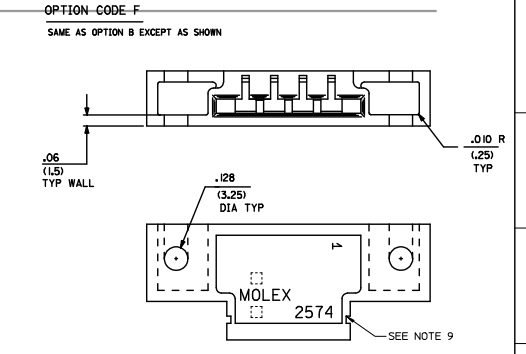
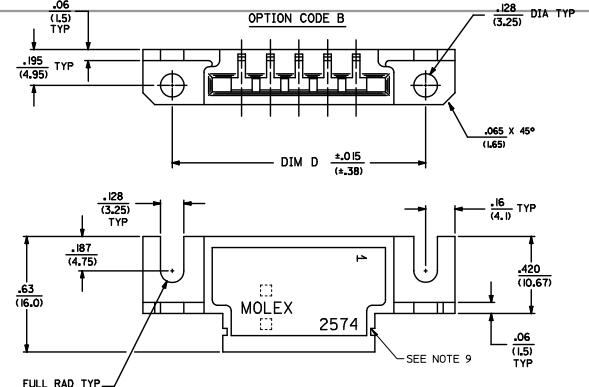
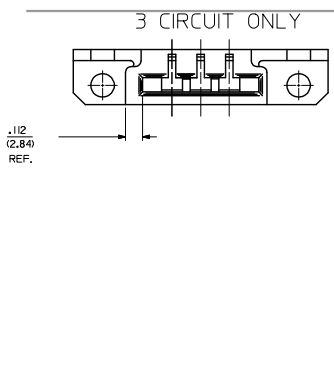

NO. OF CKT'S	DIM. C	DIM. D	DIM. E	DIM. A
3	.632 (16.05)	1.143 (29.03)	.312±.002 (7.92±.05)	.618 (15.70)
4	.788 (20.02)	1.224 (31.09)	.468±.002 (11.89±.05)	.774 (19.66)
5	.944 (23.98)	1.380 (35.05)	.624±.003 (15.85±.08)	.922 (23.42)
6	1.100 (27.94)	1.536 (39.01)	.780±.003 (19.81±.08)	1.078 (27.38)
7	1.256 (31.90)	1.692 (42.98)	.936±.003 (23.77±.08)	1.232 (31.29)
8	1.412 (35.86)	1.848 (46.94)	1.092±.004 (27.74±.10)	1.388 (35.26)
9	1.568 (39.83)	2.004 (50.90)	1.248±.004 (31.70±.10)	1.544 (39.22)
10	1.724 (43.79)	2.160 (54.86)	1.404±.005 (35.66±.15)	1.700 (43.18)
11	1.880 (47.75)	2.316 (58.83)	1.560±.006 (39.62±.15)	1.854 (47.09)
12	2.036 (51.71)	2.472 (62.79)	1.716±.006 (43.59±.15)	2.010 (51.05)
13	2.192 (55.68)	2.628 (66.75)	1.872±.006 (47.55±.15)	2.164 (54.97)
14	2.348 (59.64)	2.784 (70.71)	2.028±.007 (51.51±.18)	2.318 (58.88)
15	2.504 (63.60)	2.940 (74.68)	2.184±.007 (55.47±.18)	2.474 (62.84)
16	2.660 (67.56)	3.096 (78.64)	2.340±.007 (59.44±.18)	2.631 (66.83)
17	2.816 (71.53)	3.252 (82.60)	2.496±.008 (63.40±.20)	2.784 (70.71)
18	2.972 (75.49)	3.408 (86.56)	2.652±.009 (67.36±.23)	2.954 (75.03)
19	3.128 (79.45)	3.564 (90.53)	2.808±.009 (71.32±.23)	3.095 (78.61)
20	3.284 (83.41)	3.720 (94.49)	2.964±.009 (75.29±.23)	3.251 (82.58)
21	3.440 (87.38)	3.876 (98.45)	3.120±.010 (79.25±.25)	3.407 (86.54)
22	3.596 (91.34)	4.032 (102.41)	3.276±.011 (83.21±.25)	3.562 (90.47)
23	3.752 (95.30)	4.188 (106.38)	3.432±.011 (87.17±.28)	3.716 (94.39)
24	3.908 (99.26)	4.344 (110.34)	3.588±.012 (91.14±.30)	3.871 (98.32)

SEE SHEET 1 DEC NO: UCP2015-0556 DRAWN: JIFUX 2014/08/07 CHKD: KIPER 2014/08/08 APPROV: SMITH 2014/08/29 D4	QUALITY SYMBOLS 	GENERAL TOLERANCES (UNLESS SPECIFIED)		DIMENSION STYLE IN/MM		SCALE ---	DESIGN UNITS INCH	THIRD ANGLE PROJECTION	
		4 PLACES ±.010 3 PLACES ±.015 2 PLACES ±.025 1 PLACE ±.036 0 PLACE ±.050	mm INCH	DRAWN BY PEREZ-ARGUET	DATE 1988/03/02	TITLE EDGE CARD CONNECTOR .156/(3.96) CENTERS CRIMP TYPE-2574 SERIES			
		ANGULAR ± 3° DRAFT WHERE APPLICABLE MUST REMAIN WITHIN DIMENSIONS	SEE CHART	APPROVED BY F SMITH	DATE 2012/08/13	MATERIAL NO. DOCUMENT NO. SD-2574			
		THIS DRAWING CONTAINS INFORMATION THAT IS PROPRIETARY TO MOLEX INCORPORATED AND SHOULD NOT BE USED WITHOUT WRITTEN PERMISSION		SHEET NO. 2 OF 3					

12 11 10 9 8 7 6 5 4 3 2 1



13 12 11 10 9 8 7 6 5 4 3 2 1

2574-NA*		2574-NB*		2574-NC*		2574-ND*		2574-NE*		2574-NF*	
PART NO.	ENG. NO. (SUFFIX ONLY)	PART NO.	ENG. NO. (SUFFIX ONLY)	PART NO.	ENG. NO. (SUFFIX ONLY)	PART NO.	ENG. NO. (SUFFIX ONLY)	PART NO.	ENG. NO. (SUFFIX ONLY)	PART NO.	ENG. NO. (SUFFIX ONLY)
09-01-6031	-3A1	09-01-7031	-3B1	09-01-6038	-3C1		-3D1		-4E1	09-01-7065	-6F1-BK
09-01-6041	-4A1	09-01-7041	-4B1	09-01-6048	-04C1		-08D1		-6E1	09-01-7087	-8F1-BK
09-01-6051	-5A1	09-01-7051	-5B1	09-01-6088	-08C1		-20D1				
09-01-6064	-6A1	09-01-7064	-6B1		-20C1						
09-01-6081	-8A1	09-01-7081	-8B1								
	-8A1D	09-01-7069	-8B1D								
09-01-6055	-5A2		-8B1D								
09-01-6061	-6A2	09-01-7061	-6B2								
09-01-6085	-8A2	09-01-7085	-8B2								
09-01-6095	-9A2	09-01-7095	-9B2								
09-01-6071	-7A3	09-01-7071	-7B3								
09-01-6086	-8A3	09-01-7086	-8B3								
09-01-6083	-8A4	09-01-7083	-8B4								
09-01-6094	-9A4	09-01-7094	-9B4								
09-01-6091	-9A5	09-01-7091	-9B5								
09-01-6101	-10A6	09-01-7101	-10B6								
09-01-6121	-12A7	09-01-7121	-12B7								
09-01-6129	-12A4	09-01-7129	-12B4								
09-01-6181	-18A8	09-01-7181	-18B8								
09-01-6191	-18A9	09-01-7191	-18B9								
09-01-6161	-16A9	09-01-7161	-16B9								
09-01-6171	-17A10	09-01-7171	-17B10								
09-01-6211	-21A11	09-01-7211	-21B11								
09-01-6224	-22A12	09-01-7224	-22B12								
09-01-6221	-22A13	09-01-7221	-22B13								
09-01-6191	-19A14	09-01-7191	-19B14								
09-01-6241	-24A15	09-01-7241	-24B15								
09-01-7222	-22A16		-6B1-BK								

SEE SHEET 1 IEC NO: UCP2015-0556 DRAWN: JDFX 2014/08/07 CHECKED: JIPER 2014/08/08 APPROVED: SMITH 2014/08/29 D4	QUALITY SYMBOLS ∇=0 ∇=0 ∇=0	GENERAL TOLERANCES (UNLESS SPECIFIED) mm INCH 4 PLACES ± --- ± --- 3 PLACES ± --- ± .010 2 PLACES ± 0.25 ± .015 1 PLACE ± 0.36 ± --- 0 PLACE ± --- ± --- ANGULAR ± 3 ° DRAFT WHERE APPLICABLE MUST REMAIN WITHIN DIMENSIONS	DIMENSION STYLE IN/MM DRAWN BY PEREZ-ARGUET 1988/03/02 CHECKED BY DATE PATEL 1988/03/02 APPROVED BY DATE F SMITH 2012/08/13	SCALE --- DESIGN UNITS INCH THIRD ANGLE PROJECTION	TITLE EDGE CARD CONNECTOR .156/(3.96) CENTERS CRIMP TYPE-2574 SERIES molex	MATERIAL NO. DOCUMENT NO. SD-2574 SHEET NO. 3 OF 3

1b_frame_C_P_AM_T Rev. G 2012/01/11 12 11 10 9 8 7 6 5 4 3 2 1