

Excellent Integrated System Limited

Stocking Distributor

Click to view price, real time Inventory, Delivery & Lifecycle Information:

[IXYS Integrated Circuits Division](#)
[CPC3730C](#)

For any questions, you can email us directly:

sales@integrated-circuit.com

$BV_{DSX}/$ BV_{DGX}	$R_{DS(ON)}$ (max)	I_{DSS} (min)	Package
350V	30Ω	140mA	SOT-89

Features

- Depletion mode device offers low $R_{DS(ON)}$ at cold temperatures
- Low on resistance 30 ohms max. at 25°C
- High input impedance
- High breakdown voltage 350V
- Low $V_{GS(off)}$ voltage -1.6 to -3.9V
- Small package size SOT-89

Applications

- Ignition modules
- Normally-on switches
- Solid state relays
- Converters
- Telecommunications
- Power supply

Package Pinout

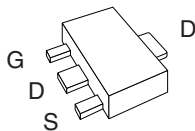

(SOT-89)

Description

The CPC3730C is an N-channel depletion mode field effect transistor (FET) that utilizes Clare's proprietary third generation vertical DMOS process. Third generation process realizes world class, high voltage MOSFET performance in an economical silicon gate process. Our vertical DMOS process yields a robust device for high power applications with high input impedance. The CPC3730C is a highly reliable FET device that has been used extensively in Clare's solid state relays for industrial and telecommunications applications.

This device excels in power applications requiring low drain-source resistance, particularly in cold environments such as automotive ignition modules. The CPC3730C offers a low 30 ohm maximum on-state resistance at 25°C.

The CPC3730C has a minimum breakdown voltage of 350V and is available in an SOT-89 package. As with all MOS devices, the FET structure prevents thermal runaway and thermal-induced secondary breakdown.

Ordering Information

Part #	Description
CPC3730C	SOT-89 (100/Tube)
CPC3730CTR	SOT-89 (2000/Reel)

Switching Waveform

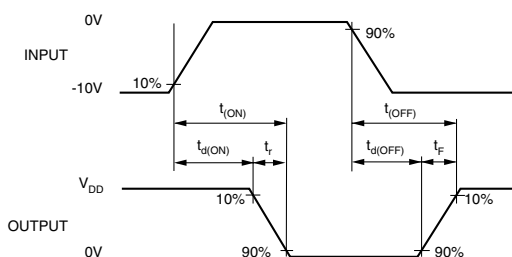

Test Circuit

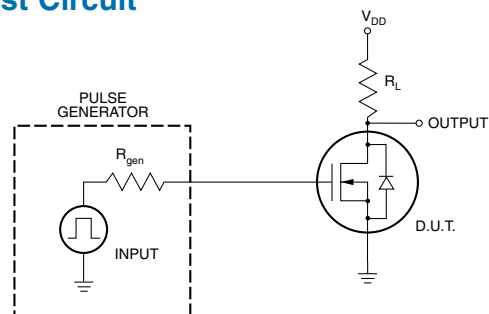

CPC3730C

Absolute Maximum Ratings (@ 25°C)

Parameter	Ratings	Units
Drain-to-Source Voltage	350	V
Gate-to-Source Voltage	±20	V
Total Package Dissipation	1.6 ¹	W
Operational Temperature	-55 to +125	°C
Storage Temperature	-55 to +125	°C

¹ Mounted on FR4 board 1"x1"x0.062"

Absolute Maximum Ratings are stress ratings. Stresses in excess of these ratings can cause permanent damage to the device. Functional operation of the device at conditions beyond those indicated in the operational sections of this data sheet is not implied.

Electrical Characteristics

Parameter	Symbol	Conditions	Min	Typ	Max	Units
Drain-to-Source Breakdown Voltage	BV_{DSX}	$V_{GS} = -5V, I_D = 100\mu A$	350	-	-	V
Gate-to-Source Off Voltage	$V_{GS(off)}$	$I_{DS} = 15V, I_D = 1mA$	-1.6	-	-3.9	V
Change in $V_{GS(off)}$ with Temperatures	$dV_{GS(off)}/dT$	$V_{DS} = 15V, I_D = 1mA$	-	-	4.5	mV/°C
Gate Body Leakage Current	I_{GSS}	$V_{GS} = \pm 20V, V_{DS} = 0V$	-	-	100	nA
Drain-to-Source Leakage Current	$I_{D(off)}$	$V_{GS} = -5V, V_{DS} = \text{Max Rating}$	-	-	1	μA
		$V_{GS} = -5V, V_{DS} = 0.8 \text{ Max Rating } T_A = 125^\circ C$	-	-	1	mA
Saturated Drain-to-Source Current	I_{DSS}	$V_{GS} = 0V, V_{DS} = 15V$	140mA	-	-	mA
Static Drain-to-Source On-State Resistance	$R_{DS(on)}$	$V_{GS} = 0V, I_D = 140mA$	-	-	30	Ω
Change in $R_{DS(on)}$ with Temperatures	$dR_{DS(on)}/dT$	$V_{GS} = 0V, I_D = 140mA$	-	-	1.1	%/°C
Forward Transconductance	G_{FS}	$I_D = 100mA, V_{DS} = 10V$	150	-	-	m \bar{O}
Input Capacitance	C_{ISS}	$V_{GS} = -5V$ $V_{DS} = 25V$ $f = 1Mhz$	-	100	200	pF
Common Source Output Capacitance	C_{OSS}		-	20	100	
Reverse Transfer Capacitance	C_{RSS}		5	80		
Turn-ON Delay Time	$t_{d(on)}$	$V_{DD} = 25V$ $I_D = 150mA$ $V_{GS} = 0V \text{ to } -10V$ $R_{GEN} = 50\Omega$	-	20	ns	
Rise Time	t_r		-	10		
Turn-OFF Delay Time	$t_{d(off)}$		-	20		
Fall time	t_f		-	50		
Source-Drain Diode Voltage Drop	V_{SD}	$V_{GS} = -5V, I_{SD} = 150mA$	-	0.6	1.8	V

Thermal Characteristics

Package	I_D (continuous)	I_D (pulsed)	Power Dissipation @ $T_A = 25^\circ C$	θ_{jc} °C/W	I_{DR}	I_{DRM}
SOT-89	140mA	600mA	1.6W ¹	15	140mA	600mA

¹ Mounted on FR4 board 1"x1"x0.062"

PERFORMANCE DATA*

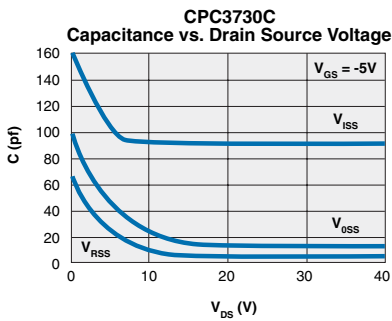
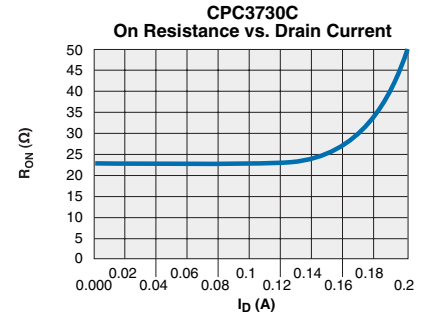
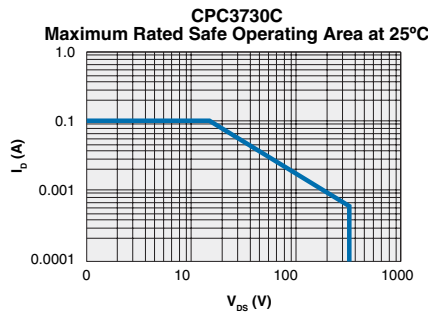
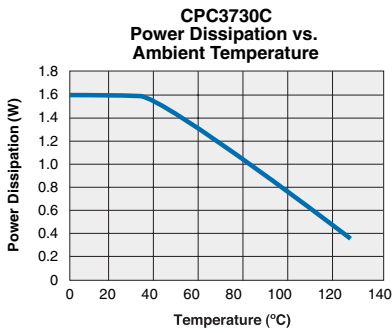
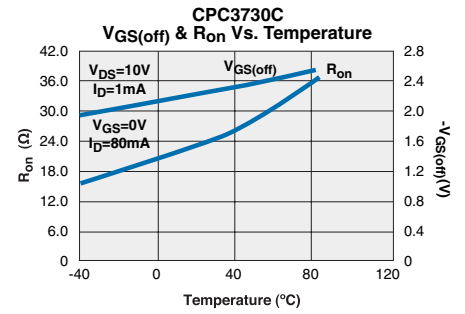
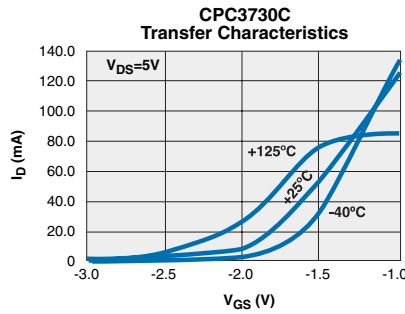
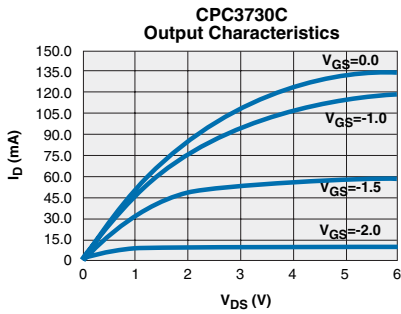

*The Performance data shown in the graphs above is typical of device performance. For guaranteed parameters not indicated in the written specifications, please contact our application department.



Manufacturing Information

Soldering

Recommended soldering processes are limited to 220°C component body temperature for 10 seconds.

Washing

Clare does not recommend ultrasonic cleaning or the use of chlorinated solvents.

MECHANICAL DIMENSIONS

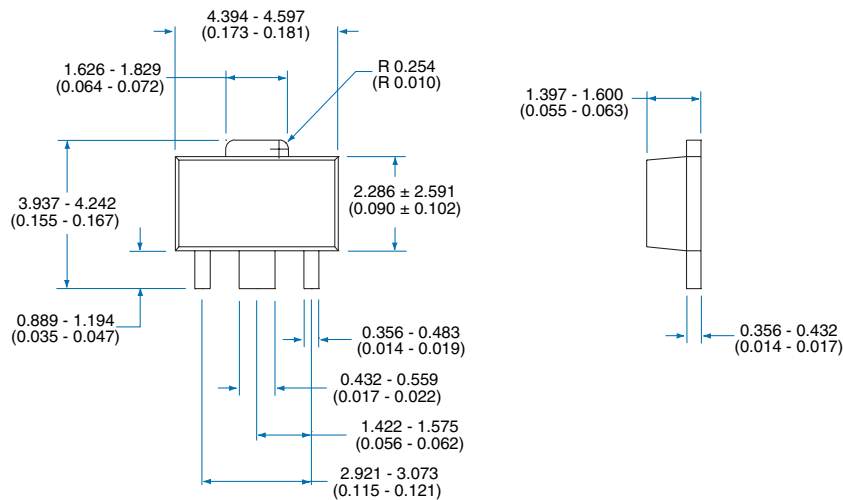

Tape and Reel Information

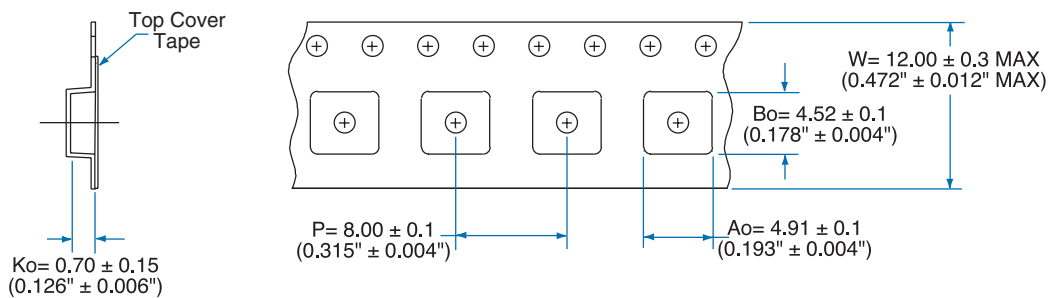

Dimensions:
mm
(inches)

For additional information please visit our website at: www.clare.com

Clare, Inc. makes no representations or warranties with respect to the accuracy or completeness of the contents of this publication and reserves the right to make changes to specifications and product descriptions at any time without notice. Neither circuit patent licenses nor indemnity are expressed or implied. Except as set forth in Clare's Standard Terms and Conditions of Sale, Clare, Inc. assumes no liability whatsoever, and disclaims any express or implied warranty, relating to its products including, but not limited to, the implied warranty of merchantability, fitness for a particular purpose, or infringement of any intellectual property right.

The products described in this document are not designed, intended, authorized or warranted for use as components in systems intended for surgical implant into the body, or in other applications intended to support or sustain life, or where malfunction of Clare's product may result in direct physical harm, injury, or death to a person or severe property or environmental damage. Clare, Inc. reserves the right to discontinue or make changes to its products at any time without notice.