

Excellent Integrated System Limited

Stocking Distributor

Click to view price, real time Inventory, Delivery & Lifecycle Information:

[ITT Cannon, LLC](#)
[CA06COME22-28P](#)

For any questions, you can email us directly:

sales@integrated-circuit.com

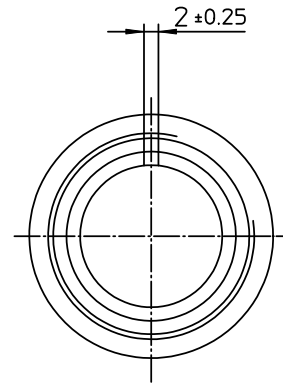
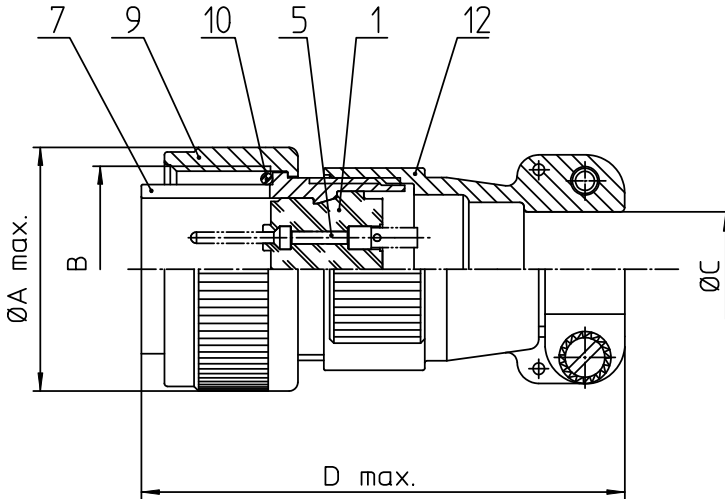

NO.	MASSE / DIMENSION
A	40,5
B	1 3/-18UNEF-2A
C	19
D	68

NO.	BESCHREIBUNG / DESCRIPTION
1	ISOLIERKÖRPER STIFT / INSULATOR PIN
5	KONTAKTSTIFT/ CONTACT PIN
7	ZYLINDERGHÄUSE / BARREL
9	ÜBERWURFMUTTER / COUPLING NUT
12	ENDGEHÄUSE / ENDBELL

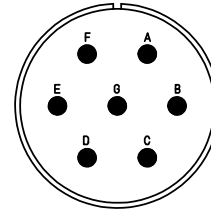

Note: Due to an automatic nomenclature system, numbers generated may not be sequential.

Specification and Dimensions subject to change
Drawings illustrate normal insulator positioning

Material Specification:

Shell Material: Aluminium alloy
Shell Plating: Nickel plated
Insulator Material: CR-Elastomere
Contact Material: Copper alloy
Contact Plating: Hard silver

all dimensions are in mm

Dimensions without tolerance indications are general tolerances in acc. with DIN7168m

drawing for
CUSTOMER



description CA06COM-E22-28P
Plug, straight
Endbell with clamp and bushing
Solder Cup / Pin / Layout: 22-28

© All rights reserved. Reproduction or issue to third in any form
whenever is only permitted with written authorization of ITT Cannon

page 1/1 revision 480 3. Jul 16