

Excellent Integrated System Limited

Stocking Distributor

Click to view price, real time Inventory, Delivery & Lifecycle Information:

[Alpha & Omega Semiconductor Inc.](#)
[AOI4N60](#)

For any questions, you can email us directly:

sales@integrated-circuit.com



AOD4N60/AOI4N60/AOU4N60

600V,4A N-Channel MOSFET

General Description

The AOD4N60 & AOI4N60 & AOU4N60 have been fabricated using an advanced high voltage MOSFET process that is designed to deliver high levels of performance and robustness in popular AC-DC applications. By providing low $R_{DS(on)}$, C_{iss} and C_{rss} along with guaranteed avalanche capability these parts can be adopted quickly into new and existing offline power supply designs.

Product Summary

V_{DS}	700V@150°C
I_D (at $V_{GS}=10V$)	4A
$R_{DS(on)}$ (at $V_{GS}=10V$)	< 2.3Ω

100% UIS Tested!
100% R_g Tested!

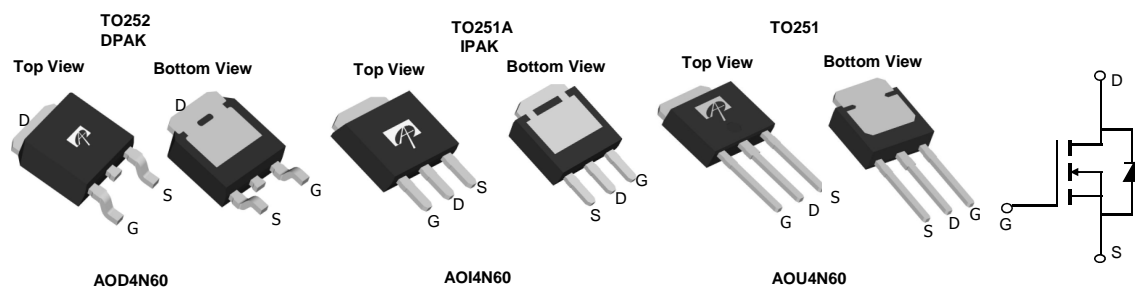

Absolute Maximum Ratings $T_A=25^\circ C$ unless otherwise noted

Parameter	Symbol	Maximum	Units
Drain-Source Voltage	V_{DS}	600	V
Gate-Source Voltage	V_{GS}	±30	V
Continuous Drain Current ^B	$T_C=25^\circ C$	4	A
	$T_C=100^\circ C$	2.6	
Pulsed Drain Current ^C	I_{DM}	14	
Avalanche Current ^C	I_{AR}	2.8	A
Repetitive avalanche energy ^C	E_{AR}	118	mJ
Single pulsed avalanche energy ^H	E_{AS}	235	mJ
MOSFET dv/dt ruggedness	dv/dt	50	V/ns
Peak diode recovery dv/dt		5	
Power Dissipation ^B	$T_C=25^\circ C$	104	W
	Derate above 25°C	0.83	W/°C
Junction and Storage Temperature Range	T_J, T_{STG}	-50 to 150	°C
Maximum lead temperature for soldering purpose, 1/8" from case for 5 seconds	T_L	300	°C

Thermal Characteristics

Parameter	Symbol	Typical	Maximum	Units
Maximum Junction-to-Ambient ^{A,G}	$R_{\theta JA}$	43	55	°C/W
Maximum Case-to-sink ^A	$R_{\theta CS}$	-	0.5	°C/W
Maximum Junction-to-Case ^{D,F}	$R_{\theta JC}$	1	1.2	°C/W

Electrical Characteristics (T_J=25°C unless otherwise noted)

Symbol	Parameter	Conditions	Min	Typ	Max	Units
STATIC PARAMETERS						
BV _{DSS}	Drain-Source Breakdown Voltage	I _D =250μA, V _{GS} =0V, T _J =25°C	600			V
		I _D =250μA, V _{GS} =0V, T _J =150°C		700		
BV _{DSS} /ΔT _J	Zero Gate Voltage Drain Current	I _D =250μA, V _{GS} =0V		0.67		V/°C
I _{DSS}	Zero Gate Voltage Drain Current	V _{DS} =600V, V _{GS} =0V			1	μA
		V _{DS} =480V, T _J =125°C			10	
I _{GSS}	Gate-Body leakage current	V _{DS} =0V, V _{GS} =±30V			±100	nA
V _{GS(th)}	Gate Threshold Voltage	V _{DS} =5V, I _D =250μA	3.4	4.1	4.5	V
R _{DS(ON)}	Static Drain-Source On-Resistance	V _{GS} =10V, I _D =2A		1.8	2.3	Ω
g _{FS}	Forward Transconductance	V _{DS} =40V, I _D =2A		6		S
V _{SD}	Diode Forward Voltage	I _S =1A, V _{GS} =0V		0.76	1	V
I _S	Maximum Body-Diode Continuous Current			4		A
I _{SM}	Maximum Body-Diode Pulsed Current			14		A
DYNAMIC PARAMETERS						
C _{iss}	Input Capacitance	V _{GS} =0V, V _{DS} =25V, f=1MHz	420	528	640	pF
C _{oss}	Output Capacitance		35	53	70	pF
C _{riss}	Reverse Transfer Capacitance		2.5	4.8	7	pF
R _g	Gate resistance	V _{GS} =0V, V _{DS} =0V, f=1MHz	1.2	2.5	3.8	Ω
SWITCHING PARAMETERS						
Q _g	Total Gate Charge	V _{GS} =10V, V _{DS} =480V, I _D =4A	9.5	12	14.5	nC
Q _{gs}	Gate Source Charge		2.8	3.6	4.5	nC
Q _{gd}	Gate Drain Charge		2.2	4.4	6.6	nC
t _{D(on)}	Turn-On DelayTime	V _{GS} =10V, V _{DS} =300V, I _D =4A, R _G =25Ω		17		ns
t _r	Turn-On Rise Time			26		ns
t _{D(off)}	Turn-Off DelayTime			34		ns
t _f	Turn-Off Fall Time			21		ns
t _{rr}	Body Diode Reverse Recovery Time	I _F =4A, dI/dt=100A/μs, V _{DS} =100V	150	190	230	ns
Q _{rr}	Body Diode Reverse Recovery Charge	I _F =4A, dI/dt=100A/μs, V _{DS} =100V	1.9	2.4	3	μC

A. The value of R_{θJA} is measured with the device in a still air environment with T_A=25° C.

B. The power dissipation P_D is based on T_{J(MAX)}=150° C in a TO252 package, using junction-to-case thermal resistance, and is more useful in setting the upper dissipation limit for cases where additional heatsinking is used.

C. Repetitive rating, pulse width limited by junction temperature T_{J(MAX)}=150° C.

D. The R_{θJA} is the sum of the thermal impedance from junction to case R_{θJC} and case to ambient.

E. The static characteristics in Figures 1 to 6 are obtained using <300 μs pulses, duty cycle 0.5% max.

F. These curves are based on the junction-to-case thermal impedance which is measured with the device mounted to a large heatsink, assuming a maximum junction temperature of T_{J(MAX)}=150° C.

G. These tests are performed with the device mounted on 1 in² FR-4 board with 2oz. Copper, in a still air environment with T_A=25° C.

H. L=60mH, I_{AS}=2.8A, V_{DD}=150V, R_G=10 Ω, Starting T_J=25° C

THIS PRODUCT HAS BEEN DESIGNED AND QUALIFIED FOR THE CONSUMER MARKET. APPLICATIONS OR USES AS CRITICAL COMPONENTS IN LIFE SUPPORT DEVICES OR SYSTEMS ARE NOT AUTHORIZED. AOS DOES NOT ASSUME ANY LIABILITY ARISING OUT OF SUCH APPLICATIONS OR USES OF ITS PRODUCTS. AOS RESERVES THE RIGHT TO IMPROVE PRODUCT DESIGN, FUNCTIONS AND RELIABILITY WITHOUT NOTICE.

TYPICAL ELECTRICAL AND THERMAL CHARACTERISTICS

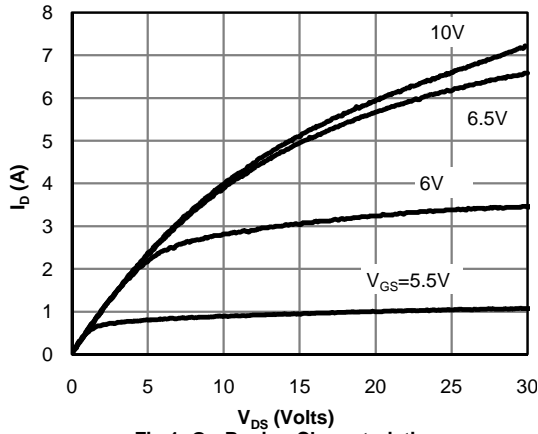

Figure 1: On-Region Characteristics

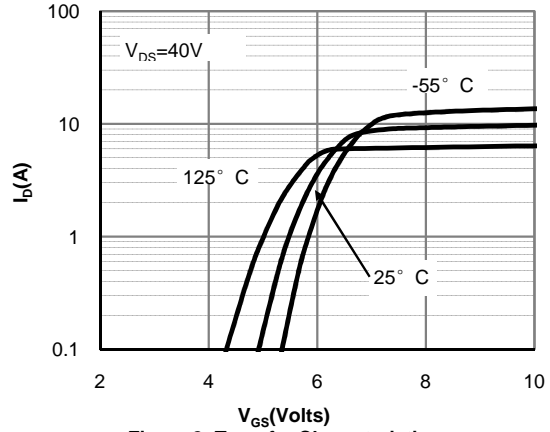

Figure 2: Transfer Characteristics

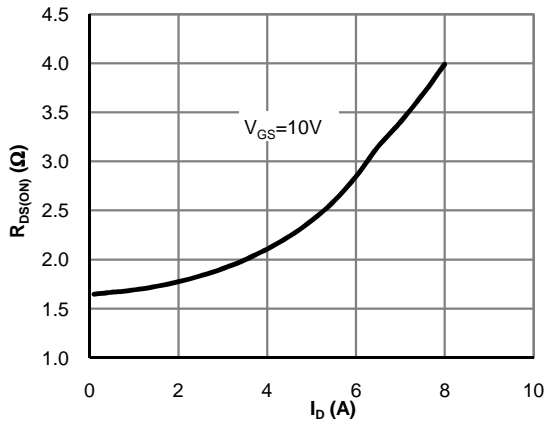

Figure 3: On-Resistance vs. Drain Current and Gate Voltage

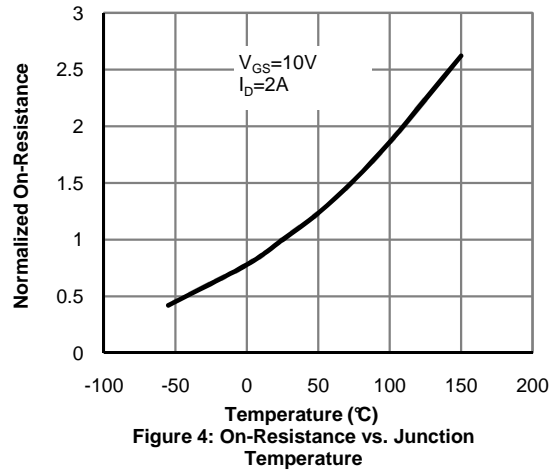

Figure 4: On-Resistance vs. Junction Temperature

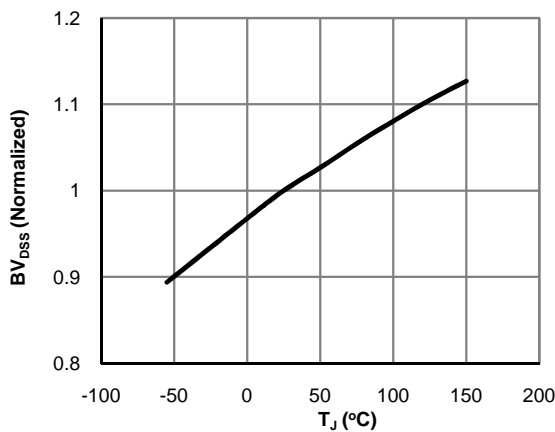

Figure 5: Break Down vs. Junction Temperature

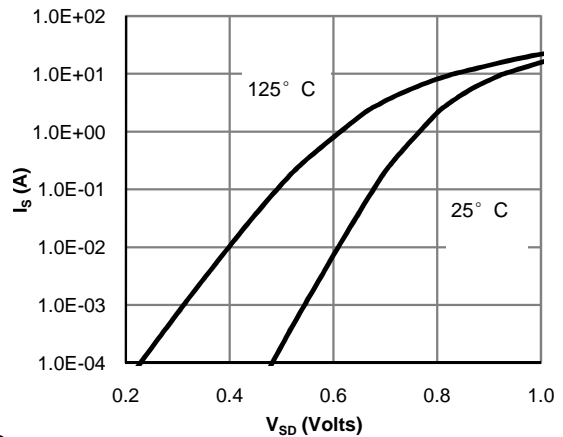

Figure 6: Body-Diode Characteristics

TYPICAL ELECTRICAL AND THERMAL CHARACTERISTICS

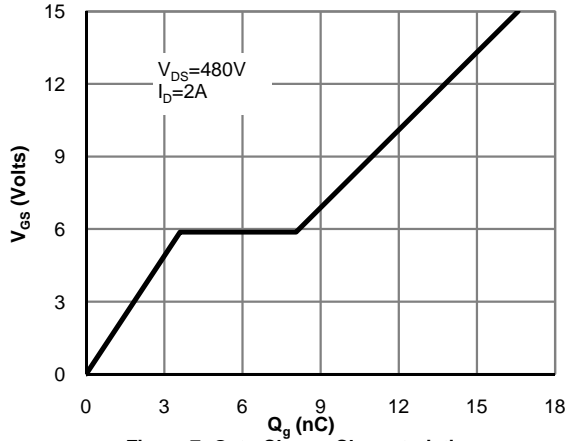

Figure 7: Gate-Charge Characteristics

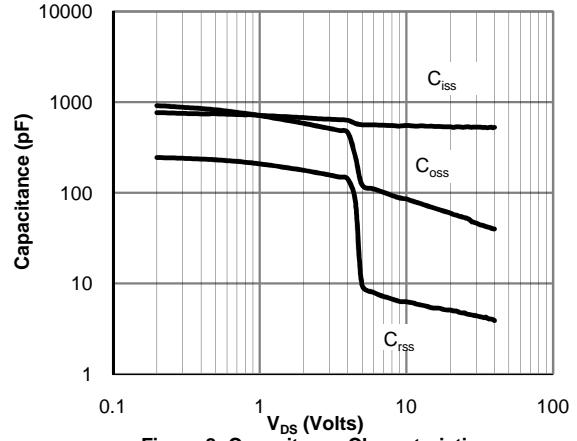

Figure 8: Capacitance Characteristics

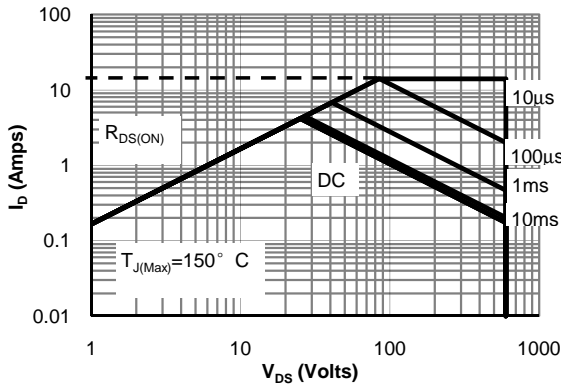

Figure 9: Maximum Forward Biased Safe Operating Area (Note F)

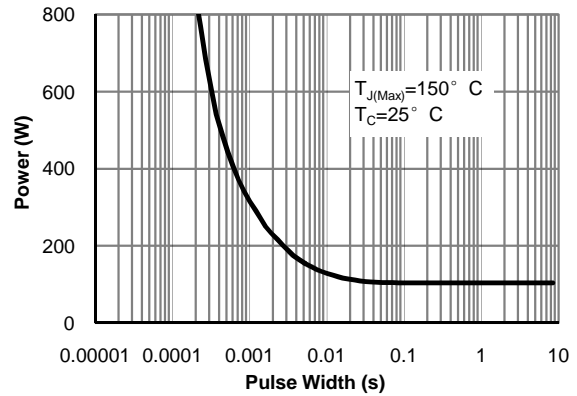

Figure 10: Single Pulse Power Rating Junction-to-Case (Note F)

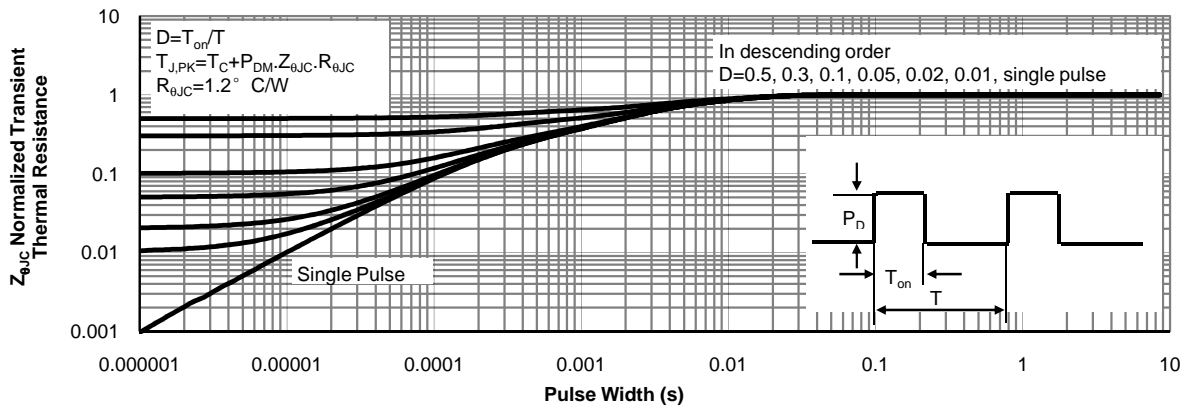

Figure 11: Normalized Maximum Transient Thermal Impedance (Note F)

TYPICAL ELECTRICAL AND THERMAL CHARACTERISTICS

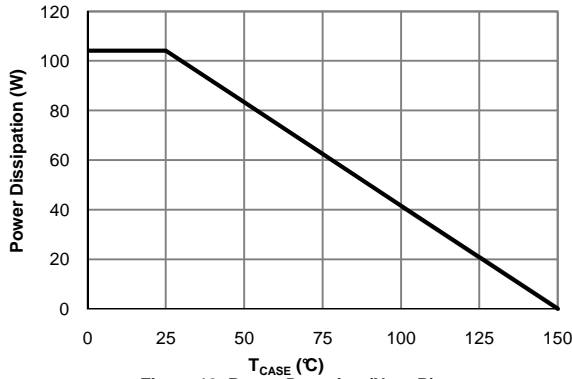

Figure 12: Power De-rating (Note B)

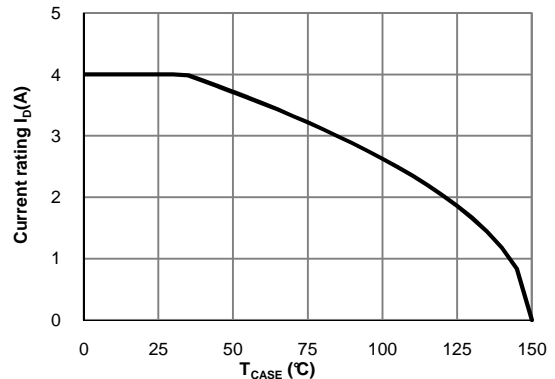

Figure 13: Current De-rating (Note B)

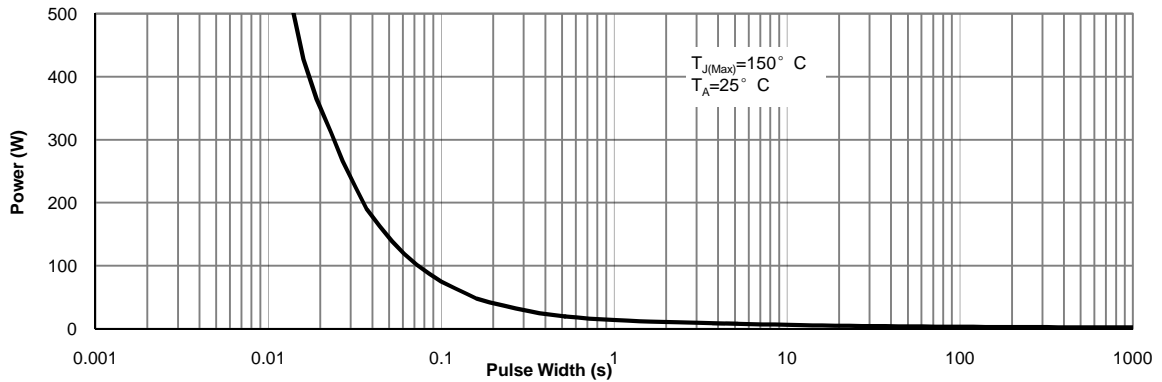

Figure 14: Single Pulse Power Rating Junction-to-Ambient (Note G)

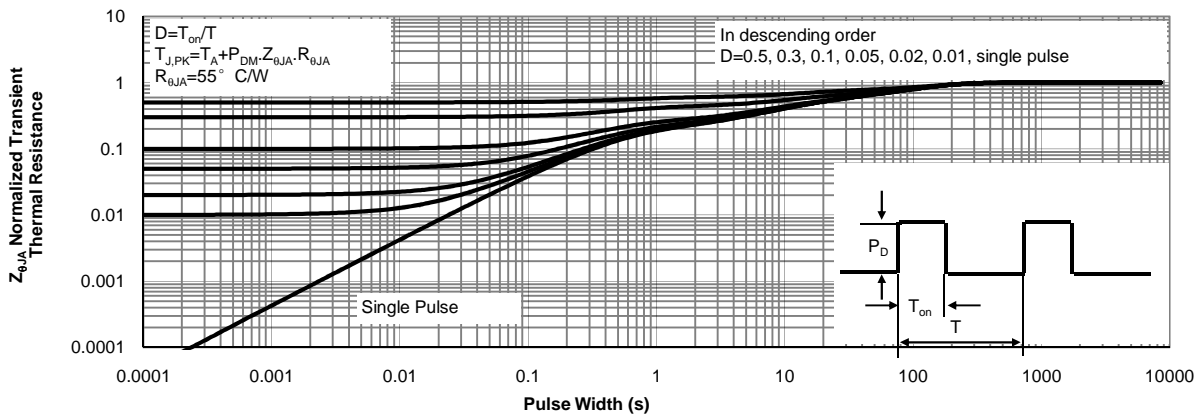
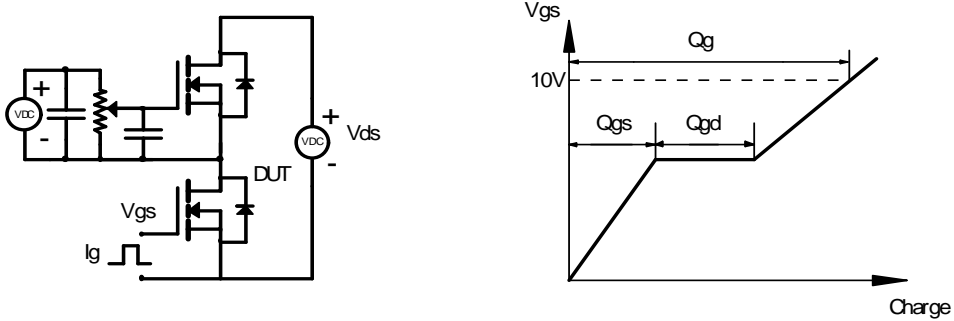
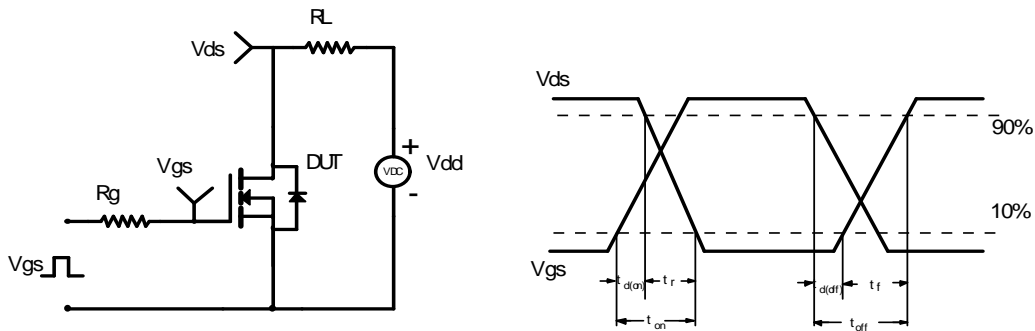

Figure 15: Normalized Maximum Transient Thermal Impedance (Note G)

Gate Charge Test Circuit & Waveform



Resistive Switching Test Circuit & Waveforms



Unclamped Inductive Switching (UIS) Test Circuit & Waveforms

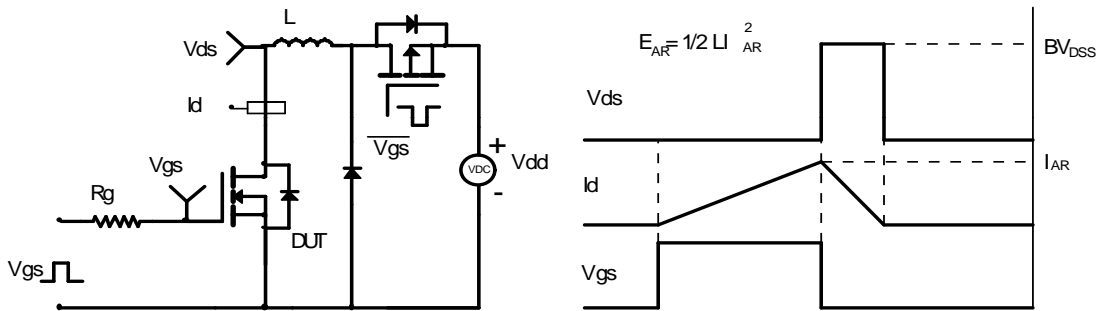

Diode Recovery Test Circuit & Waveforms

