

## Excellent Integrated System Limited

Stocking Distributor

Click to view price, real time Inventory, Delivery & Lifecycle Information:

[Alpha & Omega Semiconductor Inc.](#)  
[AOZ8075DI](#)

For any questions, you can email us directly:

[sales@integrated-circuit.com](mailto:sales@integrated-circuit.com)

### General Description

The AOZ8075 is a 6-line device integrating EMI filtering with ESD protection for each line. It is designed to suppress unwanted EMI/RFI signals and provide electrostatic discharge (ESD) protection in portable electronic equipment. This state-of-the-art device utilizes AOS leading edge Trench Vertical Structure [TVS]<sup>2</sup>™ technology for superior clamping performance and filter attenuation over the full operating display range. The AOZ8075 has been optimized for protection of color LCD displays and CCD camera lines in cellular phones and other portable consumer electronic devices.

The AOZ8075 consists of six identical circuits comprised of TVS diodes for ESD protection, and a resistor–capacitor network for EMI/RFI filtering. A series resistor value of 100 Ω and a capacitance value of 8 pF are used to achieve -20 dB minimum attenuation from 700 MHz to 3.0 GHz. The TVS diodes provide effective suppression of ESD voltages in excess of ±15 kV (contact discharge) and ±15 kV (air discharge). This exceeds the IEC 61000-4-2, level 4 ESD immunity test.

The AOZ8075 comes in an RoHS compliant, 2.50 mm x 1.20 mm DFN package and is rated over a -40 °C to +85 °C ambient temperature range.

### Features

- 6 lines for EMI filtering and ESD protection:
  - Exceeds IEC 61000-4-2, level 4 (ESD) immunity test
  - ±15 kV (contact discharge) and ±15 kV (air discharge)
- Trench Vertical Structure [TVS]<sup>2</sup>™ based technology used to achieve excellent ESD clamping and filter performance over the full operating display range
- Filter performance: -20 dB attenuation from 700 MHz to 3.0 GHz
- Low operating voltage: 5.0 V
- Capacitance stability over wide range of voltages and temperatures
- DFN package 2.50 mm x 1.20 mm
- Pb-Free device

### Applications

- EMI filtering and ESD protection for data lines
- LCD displays, camera interface, I/O interface
- Portable handheld devices, cell phones, PDA phones



### Electrical Schematic

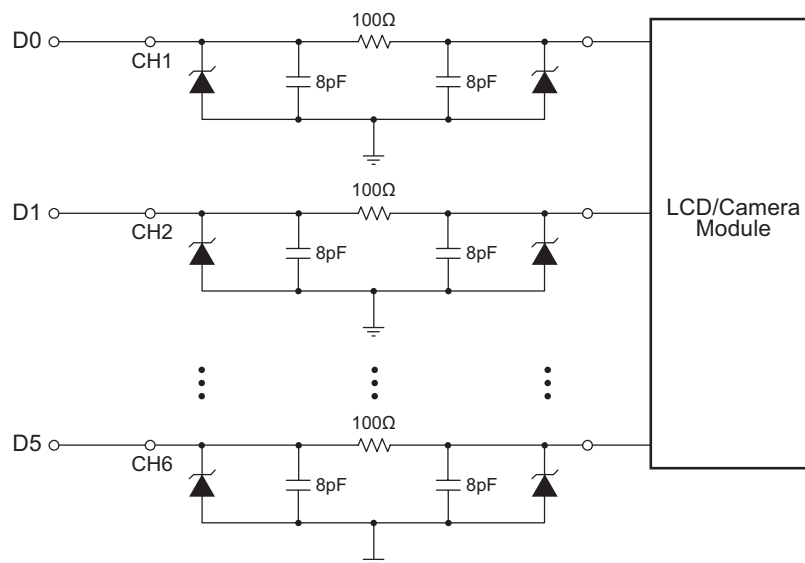

Figure 1.

### Ordering Information

Part Number	Ambient Temperature Range	Package	Environmental
AOZ8075DI	-40 °C to +85 °C	DFN-12	Green Product



AOS Green Products use reduced levels of Halogens, and are also RoHS compliant.  
 Please visit [www.aosmd.com/web/quality/rohs\\_compliant.jsp](http://www.aosmd.com/web/quality/rohs_compliant.jsp) for additional information.

### Pin Configuration

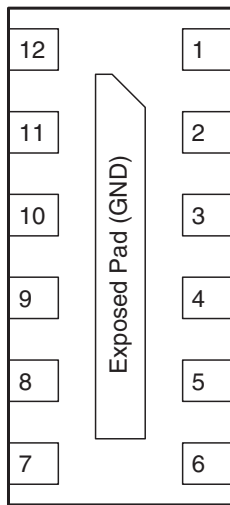

**DFN-12**  
(Bottom View)

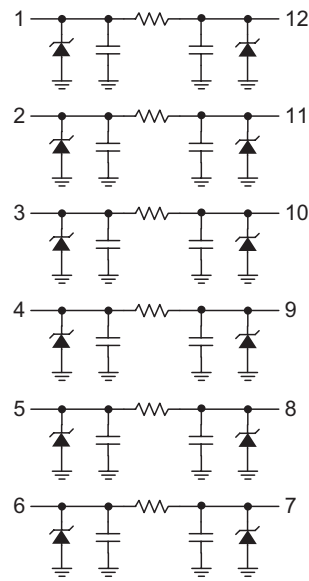

**Top View**

### Pin Description

Pin Number	Pin Name	Pin Function
1,12	CH 1	Channel 1 Connections
2, 11	CH 2	Channel 2 Connections
3, 10	CH 3	Channel 3 Connections
4, 9	CH 4	Channel 4 Connections
5, 8	CH 5	Channel 5 Connections
6, 7	CH 6	Channel 6 Connections
Exposed Pad	GND	Common Ground Connection

### Absolute Maximum Ratings

Exceeding the Absolute Maximum ratings may damage the device.

Parameter	Rating
Storage Temperature (T <sub>S</sub> )	-65 °C to +150 °C
ESD Rating per IEC61000-4-2, contact <sup>(1)</sup>	±15 kV
ESD Rating per IEC61000-4-2, air <sup>(1)</sup>	±15 kV
ESD Rating per Human Body Model <sup>(2)</sup>	±30 kV

**Notes:**

- IEC 61000-4-2 discharge with C<sub>Discharge</sub> = 150 pF, R<sub>Discharge</sub> = 330 Ω.
- Human Body Discharge per MIL-STD-883, Method 3015 C<sub>Discharge</sub> = 100 pF, R<sub>Discharge</sub> = 1.5 kΩ.

### Electrical Characteristics

T<sub>A</sub> = 25°C unless otherwise specified.

Symbol	Parameter	Conditions	Min.	Typ.	Max.	Units
V <sub>RWM</sub>	Reverse Working Voltage	(3)			5.0	V
V <sub>BR</sub>	Reverse Breakdown Voltage	I <sub>T</sub> = 1 mA <sup>(4)</sup>	6	7	8	V
I <sub>R</sub>	Reverse Leakage Current	V <sub>RWM</sub> = 3.3 V			0.1	μA
V <sub>CL</sub>	Signal Clamp Voltage	I <sub>LOAD</sub> = 1 A, positive clamp <sup>(5)(8)</sup>			9.0	V
		I <sub>LOAD</sub> = 1 A, negative clamp <sup>(5)(8)</sup>			-2.5	
		I <sub>LOAD</sub> = 5 A, positive clamp <sup>(5)(8)</sup>			11.5	
		I <sub>LOAD</sub> = 5 A, negative clamp <sup>(5)(8)</sup>			-3.5	
		I <sub>LOAD</sub> = 12 A, positive clamp <sup>(5)(8)</sup>			14.0	
		I <sub>LOAD</sub> = 12 A, negative clamp <sup>(5)(8)</sup>			-5.0	
R <sub>CH</sub>	Total Series Resistance	I <sub>R</sub> = 20 mA	90	100	110	Ω
C <sub>CH</sub>	Channel Capacitance	Input to Ground <sup>(6)(7)(8)</sup>	7	8	9	pF
f <sub>C</sub>	Cut-off Frequency	Measured with 50 Ω source and 50 Ω load termination		220		MHz
	Attenuation from 700 MHz to 3.0 GHz	V <sub>R</sub> = 0 V Measured with 50 Ω source and 50 Ω load termination		-20		dB

**Notes:**

- The working peak reverse voltage, V<sub>RWM</sub>, should be equal to or greater than the DC or continuous peak operating voltage level.
- V<sub>BR</sub> is measured at the pulse test current I<sub>T</sub>.
- Measurements performed using a 100 ns Transmission Line Pulse (TLP) system.
- Total capacitance is equal to 2 x C<sub>CH</sub>.
- Measured at 25 °C, V<sub>R</sub> = 2.5 V, f = 1.0 MHz.
- Guaranteed by design.

### Typical Performance Characteristics

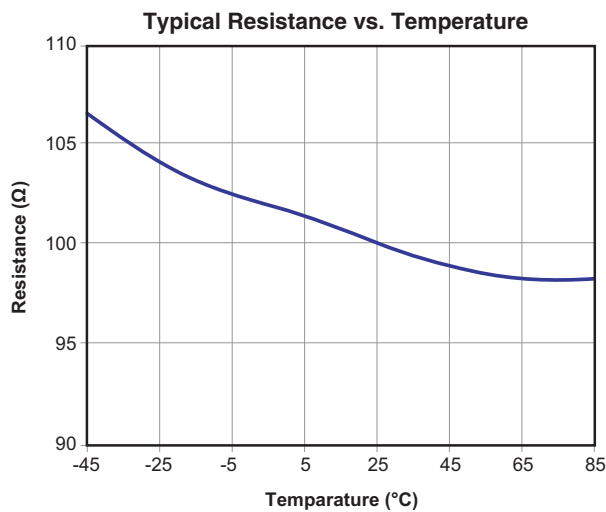
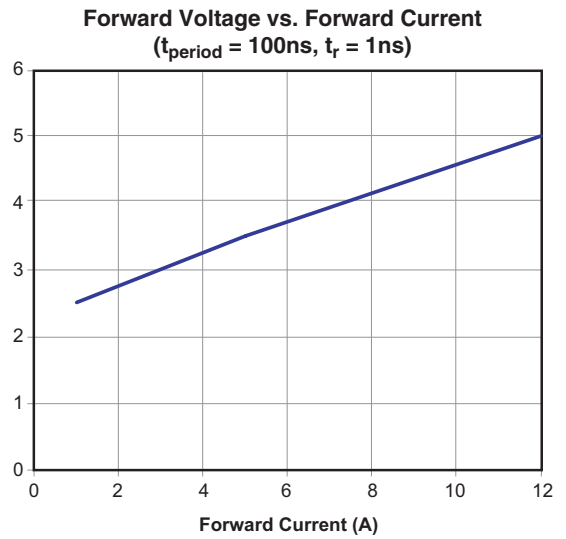
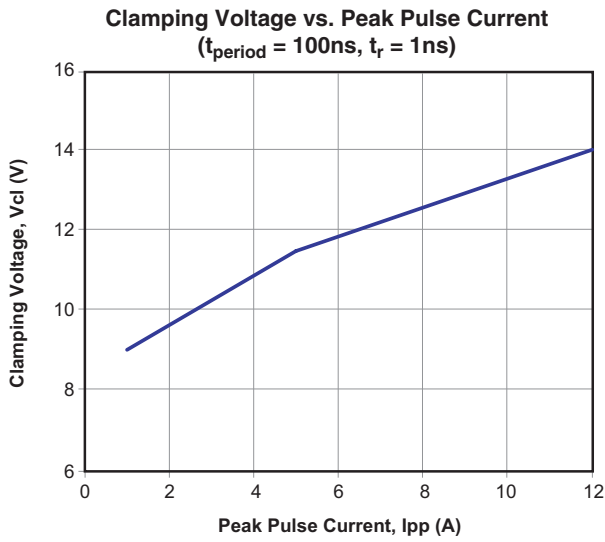
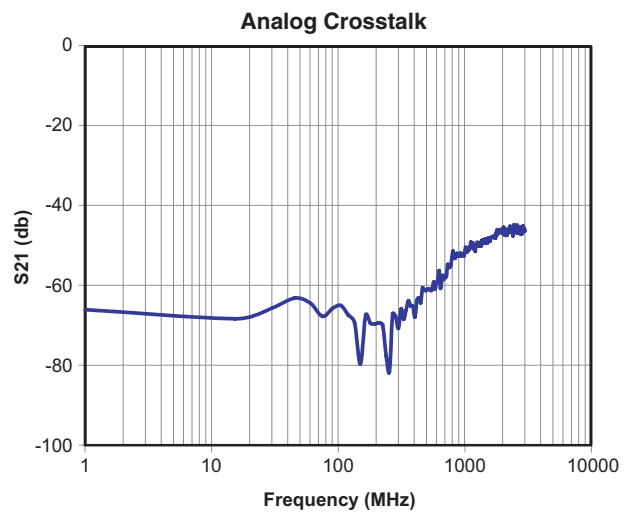
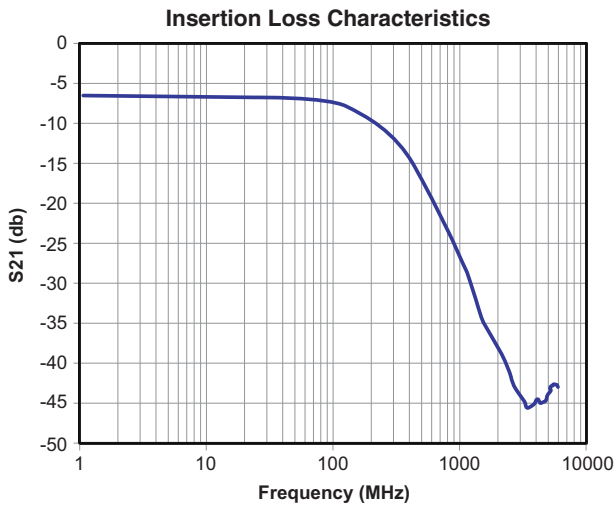

**Package Dimensions, DFN 2.5 mm x 1.2 mm, 12L EP1 S**

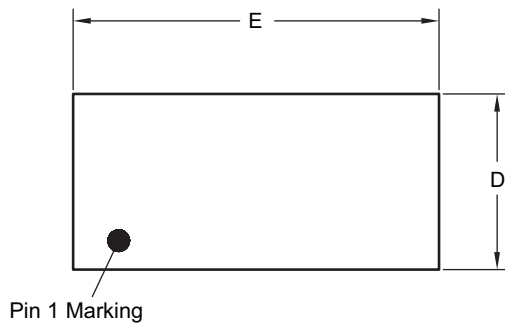

**TOP VIEW**

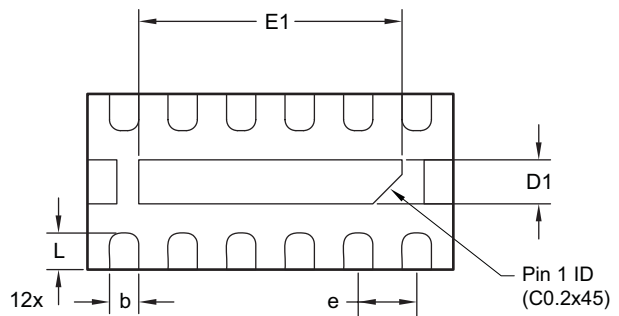

**BOTTOM VIEW**

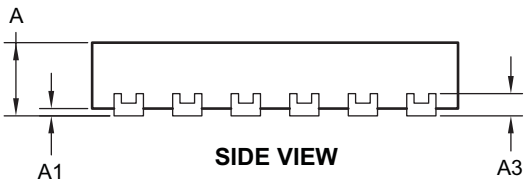

**SIDE VIEW**

**Dimensions in millimeters**

Symbols	Min.	Nom.	Max.
A	0.50	0.55	0.60
A1	0.00	—	0.05
b	0.15	0.20	0.25
A3	0.152 REF		
D	1.15	1.20	1.25
E	2.45	2.50	2.55
D1	0.25	0.30	0.35
D1	1.75	1.80	1.85
e	0.40 BSC		
L	0.20	0.24	0.30

**Dimensions in inches**

Symbols	Min.	Nom.	Max.
A	0.020	0.022	0.024
A1	0.000	—	0.002
b	0.006	0.008	0.010
A3	0.006 REF		
D	0.045	0.047	0.049
E	0.096	0.098	0.100
D1	0.010	0.012	0.014
D1	0.069	0.071	0.073
e	0.016 BSC		
L	0.008	0.010	0.012

**RECOMMENDED LAND PATTERN**

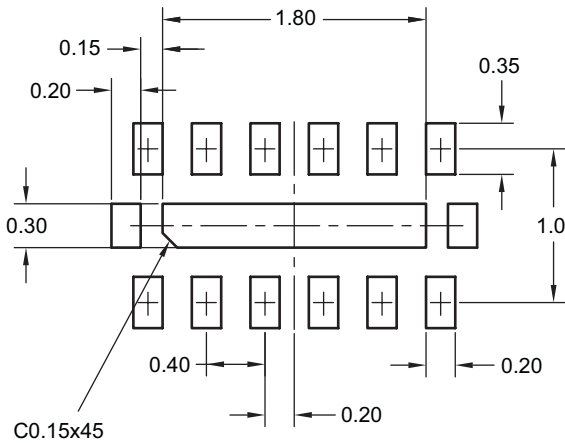

UNIT: mm

**Notes:**

1. All dimensions are in millimeters. Converted inch dimensions are not necessarily exact.

**Tape and Reel Dimensions, DFN 2.5 mm x 1.2 mm**

**Carrier Tape**

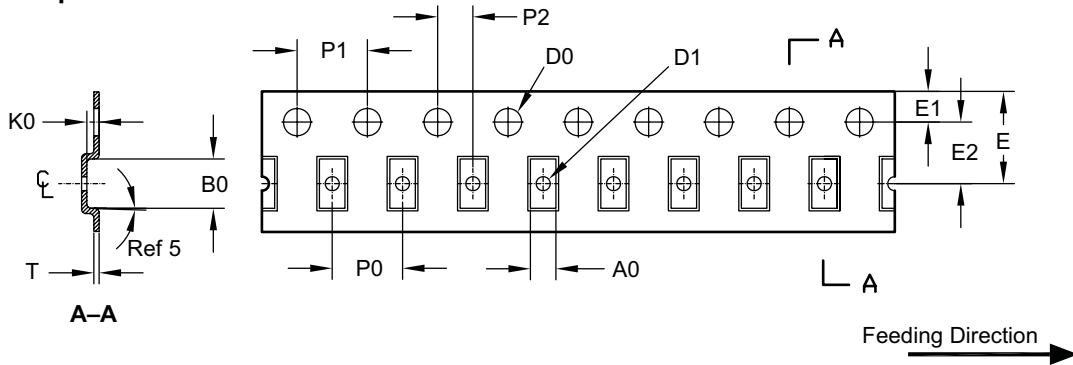

UNIT: mm

Package	A0	B0	K0	D0	D1	E	E1	E2	P0	P1	P2	T
DFN 2.5x1.2	1.45 ±0.05	2.80 ±0.05	0.70 ±0.05	∅1.55 ±0.05	∅0.80 ±0.05	8.00 ±0.03	1.75 ±0.1	3.50 ±0.05	4.00 ±0.10	4.0 ±0.10	2.0 ±0.05	0.30 ±0.05

**Reel**

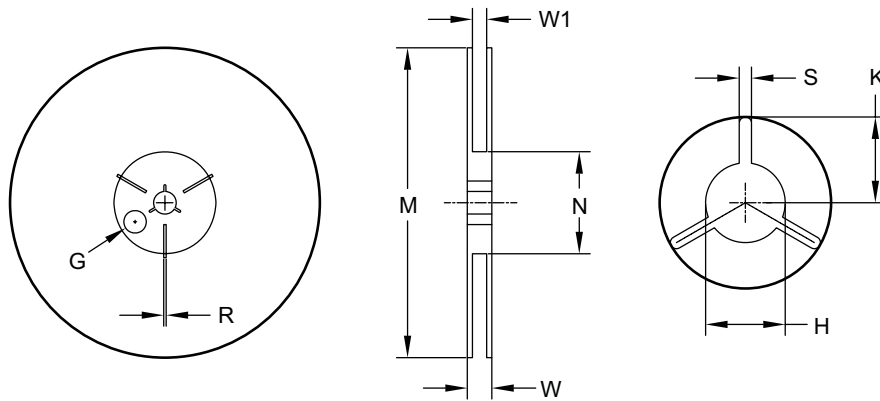

UNIT: mm

Tape Size	Reel Size	M	N	W	W1	H	S	K	E
8mm	∅178	∅178.0 ±1.0	∅60.0 ±0.5	11.80 ±0.5	9.0 ±0.5	∅13.0 +0.5 / -0.2	2.40 ±0.1	10.25 ±0.2	∅9.8

**Leader / Trailer & Orientation**

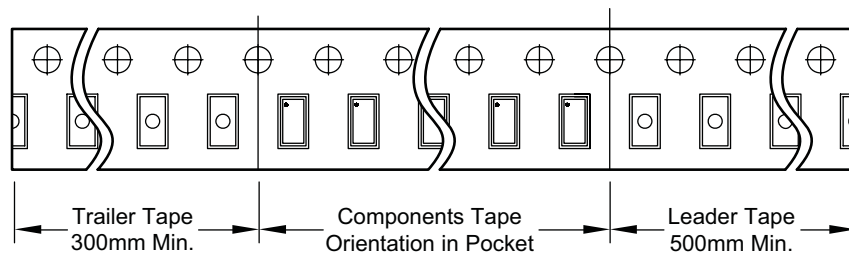

**Part Marking**

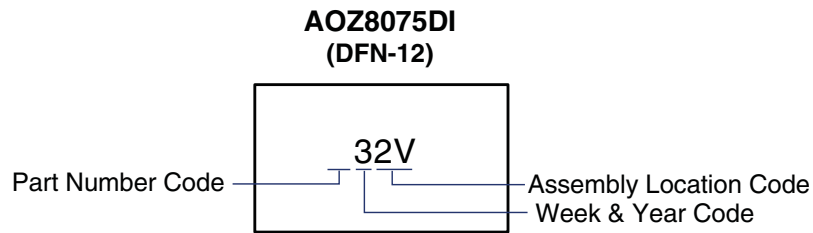

**This data sheet contains preliminary data; supplementary data may be published at a later date. Alpha & Omega Semiconductor reserves the right to make changes at any time without notice.**

**LIFE SUPPORT POLICY**

**ALPHA & OMEGA SEMICONDUCTOR PRODUCTS ARE NOT AUTHORIZED FOR USE AS CRITICAL COMPONENTS IN LIFE SUPPORT DEVICES OR SYSTEMS.**

As used herein:

- |   |   |
|---|---|
| <p>1. Life support devices or systems are devices or systems which, (a) are intended for surgical implant into the body or (b) support or sustain life, and (c) whose failure to perform when properly used in accordance with instructions for use provided in the labeling, can be reasonably expected to result in a significant injury of the user.</p> | <p>2. A critical component in any component of a life support, device, or system whose failure to perform can be reasonably expected to cause the failure of the life support device or system, or to affect its safety or effectiveness.</p> |
|---|---|