

## Excellent Integrated System Limited

Stocking Distributor

Click to view price, real time Inventory, Delivery & Lifecycle Information:

[Molex Connector Corporation](#)  
[0019091152](#)

For any questions, you can email us directly:

[sales@integrated-circuit.com](mailto:sales@integrated-circuit.com)

PLUG

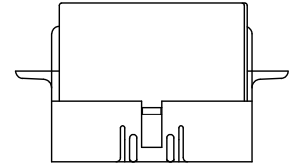
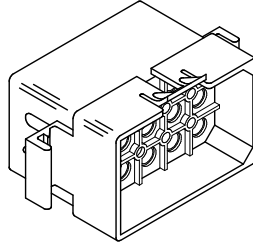
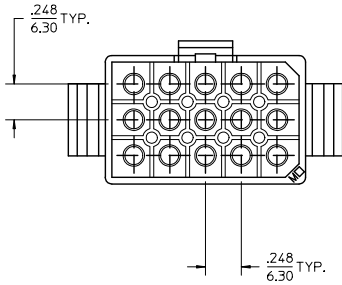
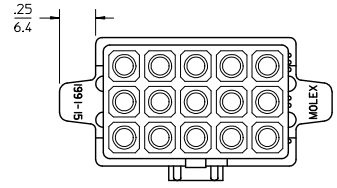
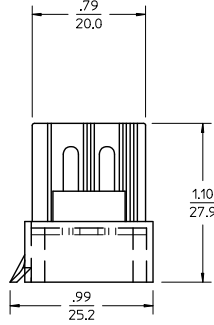
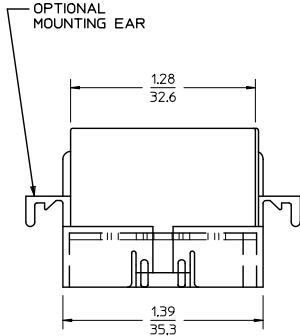
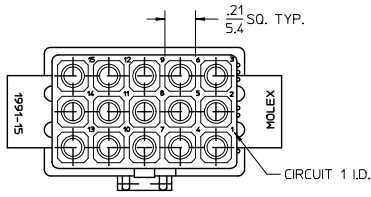

OPTIONAL PULL TAB  
1991-15P SHOWN

<b>ADD PULL TAB VIEWS</b> EC NO: UCP2014-3949 DRAWN BY: 2014/04/17 CHKD BY: CHKOBANDERSON 2014/04/17 APPROV BY: APPROV SMITH 2014/06/10 REV:	<b>QUALITY SYMBOLS</b> □=0 ▽=0 ▽=0	<b>GENERAL TOLERANCES (UNLESS SPECIFIED)</b>		<b>DIMENSION STYLE</b> IN/MM		SCALE 2:1	DESIGN UNITS INCH	THIRD ANGLE PROJECTION	
		4 PLACES ± .005 ± .005	mm	INCH	DRAWN BY	DATE	TITLE .093/(2.36) HOUSINGS, PLUG AND RECEPTACLE, 15 CKT .248/(6.30) CTRS.		
		3 PLACES ± .005 ± .010	mm	INCH	CHECKED BY	DATE	<b>molex</b> DOCUMENT NO. SD-1991-15* SHEET NO. 1 OF 3		
		2 PLACES ± 0.25 ± .014	mm	INCH	APPROVED BY	DATE			
1 PLACE ± 0.35 ± .014	mm	INCH	SMITH	2014/06/10	MATERIAL NO. SEE CHART DRAFT WHERE APPLICABLE MUST REMAIN WITHIN DIMENSIONS				
ANGULAR ± 1/2°		THIS DRAWING CONTAINS INFORMATION THAT IS PROPRIETARY TO MOLEX INCORPORATED AND SHOULD NOT BE USED WITHOUT WRITTEN PERMISSION							

RECEPTACLE

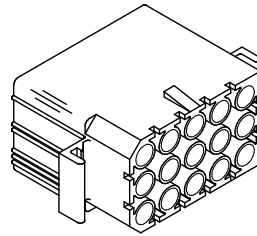
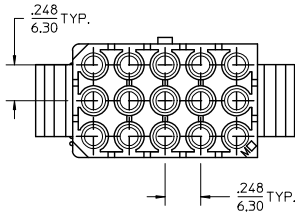
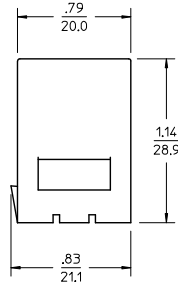
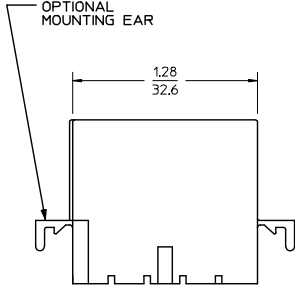
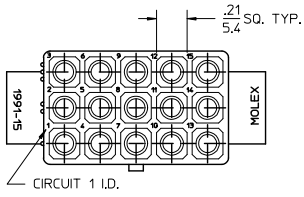

SEE SHEET 1 EC NO: UCP2014-3949 DRAWN BY: ZHANGKIPPER CHECKED BY: CHIKOBANDERSON APPROVED BY: APPRECI SMITH	QUALITY SYMBOLS □=0 ▽=0 ▽=0	GENERAL TOLERANCES (UNLESS SPECIFIED)		DIMENSION STYLE IN/MM		SCALE 2:1	DESIGN UNITS INCH	THIRD ANGLE PROJECTION
		4 PLACES ± --- ± --- 3 PLACES ± --- ± .010 2 PLACES ± 0.25 ± .014 1 PLACE ± 0.35 ± --- 0 PLACE ± --- ± ---	DRAWN BY: KBW CHECKED BY: RW APPROVED BY: F SMITH	DATE: 1989/04/25 DATE: 1989/04/25 DATE: 2014/06/10	TITLE .093/(2,36) HOUSINGS, PLUG AND RECEPTACLE, 15 CKT .248/(6.30) CTRS. <b>molex</b>			
REV: J	DESCRIPTION:	ANGULAR ±1/2° DRAFT WHERE APPLICABLE MUST REMAIN WITHIN DIMENSIONS		MATERIAL NO. SEE CHART		DOCUMENT NO. SD-1991-15*		SHEET NO. 2 OF 3

PLUG		
ORDER NO	ENG NO	PKG. INFORMATION
19-09-2151	1991-15P	PK-1991-002
19-09-2153	1991-15P2	PK-1991-002
19-09-7151	1991-15PBK	PK-1991-001
-	-	-
-	-	-

RECEPTACLE		
ORDER NO	ENG NO	PKG. INFORMATION
19-09-1151	1991-15R2	PK-1991-002
19-09-1152	1991-15R1	PK-1991-002
19-09-6151	1991-15R2BK	PK-1991-001
19-09-6152	1991-15R1BK	PK-1991-001
-	-	-
-	-	-

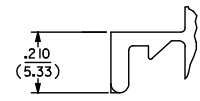
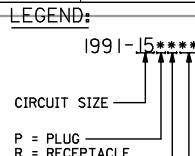

**DETAIL A**  
STANDARD MOUNTING EAR  
(SCALE 4:1)

BLANK = WITH PULL TABS  
 1 = WITHOUT EARS/WITHOUT PULL TABS  
 2 = WITH STANDARD EARS  
 3 = WITH PREBENT EARS

**COLOR:**  
 BLANK = NATURAL COLOR  
 AM = AMBER BK = BLACK BU = BLUE  
 BN = BROWN GY = GRAY GN = GREEN  
 OR = ORANGE RD = RED YW = YELLOW

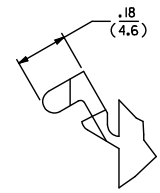
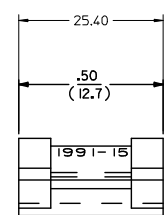
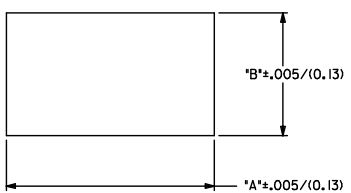
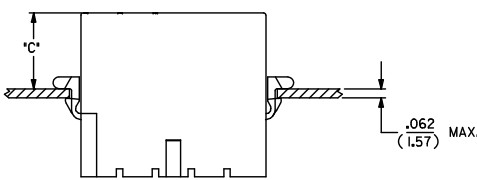

**DETAIL B**  
PREBENT MOUNTING EAR  
(SCALE 4:1)

RECOMMENDED PANEL OPENING

HOUSING	DIM. "A"	DIM. "B"	"C" PREBENT EAR	"C" STANDARD EAR
PLUG	1.552/(39.42)	.910/(23.11)	.31/(7.9)	.30/(7.6)
RECEPT.	1.442/(36.63)	.850/(21.60)	.54/(13.7)	.53/(13.5)

- NOTES:**
- MATERIAL: NYLON TYPE 6/6, 94V-2.
  - FINISH: N/A
  - PRODUCT SPECIFICATION: PS-02-09
  - PACKAGING SPECIFICATION: SEE CHART
  - HOUSINGS FOR USE WITH MOLEX STANDARD .093/(2.36) TYPE TERMINALS
  - PARTS CONFORM TO CLASS B REQUIREMENTS OF COSMETIC SPECIFICATION PS-45499-002.

QUALITY SYMBOLS	GENERAL TOLERANCES (UNLESS SPECIFIED)		DIMENSION STYLE		SCALE	DESIGN UNITS	THIRD ANGLE PROJECTION
	mm	INCH	IN/MM	DATE			
▽=0	4 PLACES ±---	±---	DRAWN BY	DATE	2:1	INCH	.093/(2.36) HOUSINGS, PLUG AND RECEPTACLE, 15 CKT .248/(6.30) CTRS. <b>molex</b>
▽=0	3 PLACES ±---	±.010	CHECKED BY	DATE			
▽=0	2 PLACES ±0.25	±.014	APPROVED BY	DATE	MATERIAL NO.		DOCUMENT NO.
▽=0	1 PLACE ±0.35	±---	DATE		SEE CHART		SD-1991-15*
▽=0	0 PLACE ±---	±---	DATE		SIZE		3 OF 3
ANGULAR ±1/2°		THIS DRAWING CONTAINS INFORMATION THAT IS PROPRIETARY TO MOLEX INCORPORATED AND SHOULD NOT BE USED WITHOUT WRITTEN PERMISSION					