

Excellent Integrated System Limited

Stocking Distributor

Click to view price, real time Inventory, Delivery & Lifecycle Information:

[Molex Connector Corporation](#)
[0022283074](#)

For any questions, you can email us directly:

sales@integrated-circuit.com

NO. OF CKTS.	DIM. A	DIM. B
2	.400/2.54	.200/5.08
3	.200/5.08	.300/7.62
4	.300/7.62	.400/10.16
5	.400/10.16	.500/12.70
6	.500/10.16	.600/15.24
7	.600/15.24	.700/17.78
8	.700/17.78	.800/20.32
9	.800/20.32	.900/22.86
10	.900/22.86	1.000/25.40
11	1.000/25.40	1.100/27.94
12	1.100/27.94	1.200/30.48
13	1.200/30.48	1.300/33.02
14	1.300/33.02	1.400/35.56
15	1.400/35.56	1.500/38.10
16	1.500/38.10	1.600/40.64
17	1.600/40.64	1.700/43.18
18	1.700/43.18	1.800/45.72
19	1.800/45.72	1.900/48.26
20	1.900/48.26	2.000/50.80
21	2.000/50.80	2.100/53.34
22	2.100/53.34	2.200/55.88
23	2.200/55.88	2.300/58.42
24	2.300/58.42	2.400/60.96
25	2.400/60.96	2.500/63.50
26	2.500/63.50	2.600/66.04
27	2.600/66.04	2.700/68.58
28	2.700/68.58	2.800/71.12
29	2.800/71.12	2.900/73.66
30	2.900/73.66	3.000/76.20
31	3.000/76.20	3.100/78.74
32	3.100/78.74	3.200/81.28
33	3.200/81.28	3.300/83.82
34	3.300/83.82	3.400/86.36
35	3.400/86.36	3.500/88.90
36	3.500/88.90	3.600/91.44

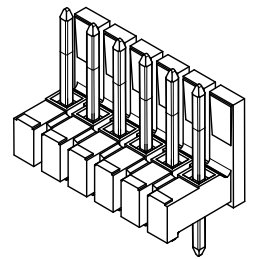
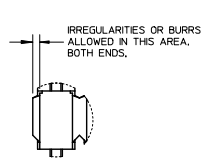
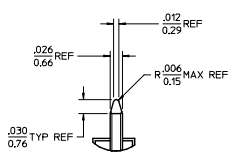
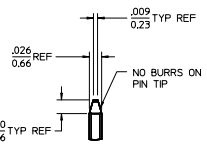

DETAIL X
SCALE 5:1
SEE NOTE 10

DETAIL Y
SCALE 5:1
SEE NOTE 10

DETAIL Z
SCALE 5:1

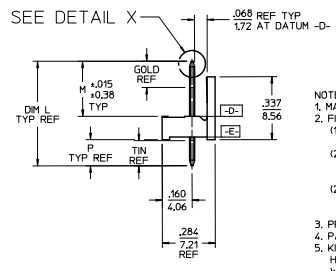
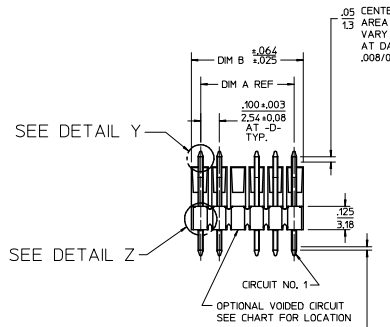

- NOTES:
1. MATERIAL: GLASS FILLED NYLON. 94V-0. COLOR: BLACK
 2. FINISH: (154) OVERALL TIN: .000100/0.00254 MIN. OVER .000050/0.00127 MIN NICKEL. (1208) SELECT GOLD: .000015/0.00038 MIN. SELECT TIN: .000100/0.00254 MIN. OVERALL NICKEL UNDERPLATE: .000050/0.00127 MIN. (1228) SELECT GOLD: .000030/0.00076 MIN. SELECT TIN: .000010/0.00254 MIN. OVERALL NICKEL UNDERPLATE: .000050/0.00127 MIN.
 3. PRODUCT SPECIFICATION PS 10-07.
 4. PACKAGING INFORMATION: SEE TABLES
 5. KINK PIN OPTION NOT RECOMMENDED FOR 2 CIRCUIT PARTS. HOLE SIZE MAY NEED TO BE ADJUSTED ON 2 CIRCUIT PARTS WITH KINK OPTION FOR PROPER INSERTION INTO THE PCB. SEE SMES-42003 FOR ADDITIONAL INFORMATION ON KINK DIRECTION AND PLACEMENT.
 6. HEADERS ARE NOT STACKABLE ON .100/2.54 CENTERS.
 7. SOLDERABILITY PER SMES-462.
 8. PIN PUSH OUT FORCE: 3 LBS. MIN.
 9. PARTS CONFORM TO CLASS 'B' REQUIREMENTS OF COSMETIC SPECIFICATION PS-45499-002.
 10. PIN TIP DIMENSIONS ARE SHOWN FOR REFERENCE ONLY. DIMENSIONS APPLY PRIOR TO PLATING OR ASSEMBLY.
 11. FIRST AND LAST CIRCUIT BACKWALLS MUST BE REMOVED WHEN MATING TO A PART WITH POLARIZING RBS.

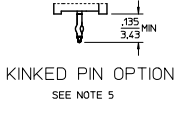

KINKED PIN OPTION
SEE NOTE 5

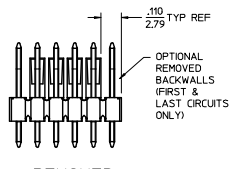

REMOVED BACKWALL OPTION
SEE NOTE 11

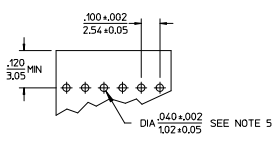

RECOMMENDED PC BOARD LAYOUT

ADD NOTE 11	DESCRIPTION	QUALITY SYMBOLS
EC NO: UCP2014-1471	2013/10/01	▽=0
DRW:KMY/PEER	2013/10/01	▽=0
CHK:RANDERSON	2013/10/01	▽=0
APP:RFS/SMITH	2013/10/09	▽=0

GENERAL TOLERANCES (UNLESS SPECIFIED)	MM	INCH
4 PLACES	± .15	± .005
3 PLACES	± .10	± .003
2 PLACES	± .075	± .002
1 PLACE	± .05	± .0015
0 PLACE	± .025	± .001

DRAWN BY	DATE	CHECKED BY	DATE
JSCHAFFER	2004/03/20	DATE	DATE
KSAMIEC	2004/03/20	DATE	DATE
MARGULIS	2004/03/20	DATE	DATE

SCALE	DESIGN UNITS	THIRD ANGLE PROJECTION
2:1	INCH	THIRD ANGLE PROJECTION

molex

SD-42225-001

1 OF *

THIS DRAWING CONTAINS INFORMATION THAT IS PROPRIETARY TO MOLEX INCORPORATED AND SHOULD NOT BE USED WITHOUT WRITTEN PERMISSION