

Excellent Integrated System Limited

Stocking Distributor

Click to view price, real time Inventory, Delivery & Lifecycle Information:

[Harting](#)
[60110145740](#)

For any questions, you can email us directly:
sales@integrated-circuit.com

Alle Rechte vorbehalten/ All rights reserved

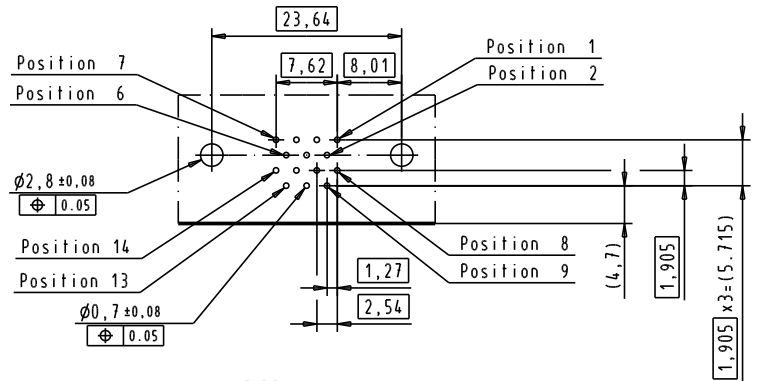
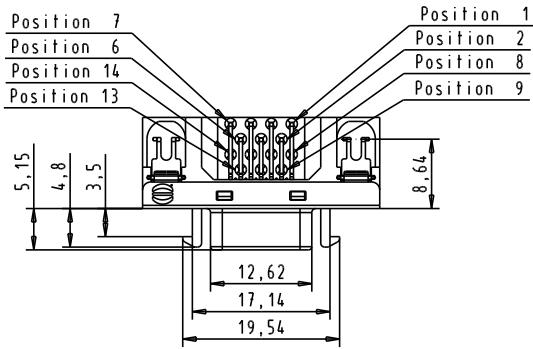

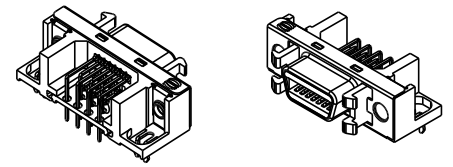
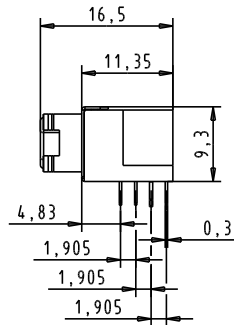
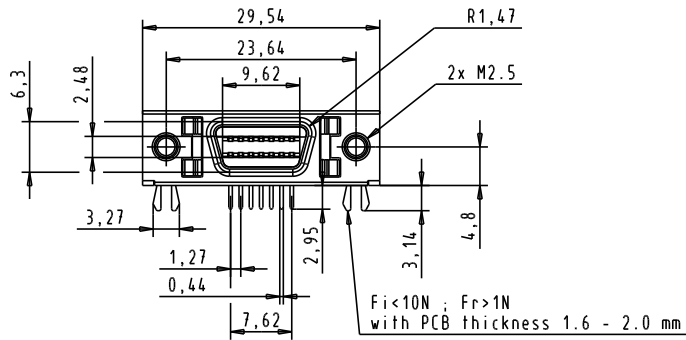

PCB Layout: component side



According to IEC 61076-3-100

1) see TB 60 11 014 5740 folio 2/2 for reel packaging

				Det.	Name	 har.mik® I/O bellow 14 poles female SMC with angled solder pins, boardlocks, fixed latches	Moßstab/ Scale
				Detail.	ED		All Dim. in mm Orig. Size DIN A 4
33811	18Oct2006	ED		Insp.		 TB 60 11 014 5740	
33795	07Aug2006	ED		Stand.			Sub.
33781	12Jul2006	ED			HARTING EURL F-95972 Paris		
Mod.	Det.	Name					