

## Excellent Integrated System Limited

Stocking Distributor

Click to view price, real time Inventory, Delivery & Lifecycle Information:

[Panasonic Electronic Components](#)  
[EVP-AJAE1A](#)

For any questions, you can email us directly:

[sales@integrated-circuit.com](mailto:sales@integrated-circuit.com)

# Panasonic

## Light Touch Switches/EVPAJ

### 4.7 mm×3.5 mm Double-action Side-operational SMD Light Touch Switches

Type: **EVPAJ**



#### ■ Features

- External dimensions : 4.7 mm×3.5 mm (Without push plate), Height : 1.2 mm
- With ground terminal

#### ■ Recommended Applications

- Camera function  
(Digital still cameras, Camcorders, Mobile phones, etc.)
- Operating switches for menu scrolling and confirmation for portable equipment.

#### ■ Explanation of Part Numbers

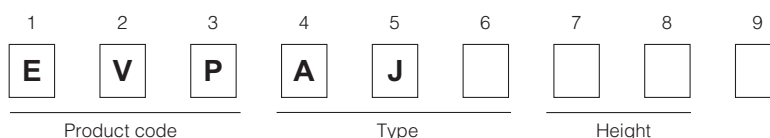



#### ■ Specifications

Type	Snap action/Push-on type SPDT	
	Rating	10 μA 2 Vdc to 20 mA 15 Vdc (Resistive load)
	Contact Resistance	500 mΩ max.
	Insulation Resistance	100 MΩ min. (at 100 Vdc)
	Dielectric Withstanding Voltage	250 Vac for 1 minute
	Bouncing	3 ms max. (ON) 20 ms max. (OFF)
Mechanical	Operating Force (1st Action)	1.6 N
	Operating Force (2nd Action)	2.6 N
	Travel (1st Action)	0.15 mm
	Travel (2nd Action)	0.4 mm
	Push Strength	30 N for 15 seconds
Endurance	Operating Life	100000 cycles min.
Operating Temperature		-20 °C to +70 °C
Storage Temperature		-40 °C to +85 °C (Bulk) -20 °C to +60 °C (Taping)
Minimum Quantity/Packing Unit		5000 pcs. Embossed Taping (Reel Pack)
Quantity/Carton		25000 pcs.

# Panasonic

## Light Touch Switches/EVPAJ

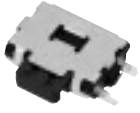
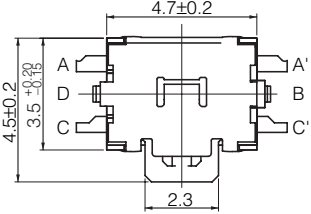
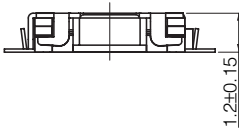
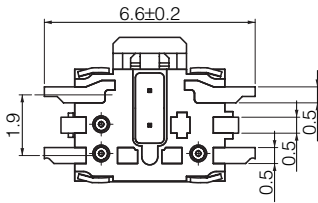
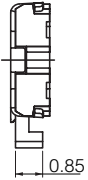
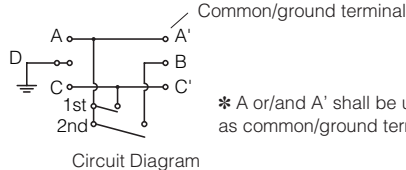
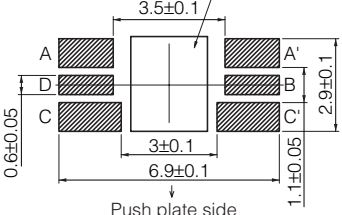
■ Dimensions in mm (not to scale)

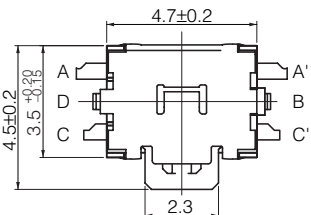
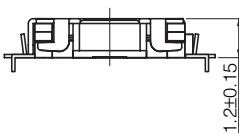
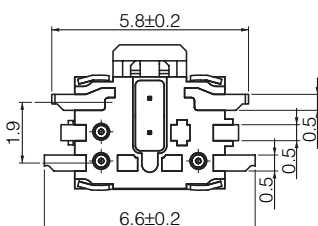
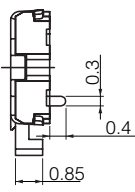
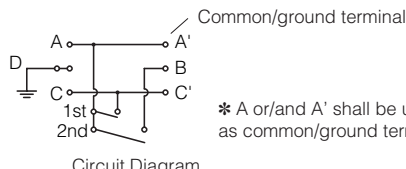
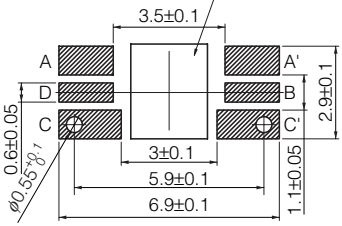
<p><b>EVPAJ</b></p> <p>(Embossed Taping) With Ground Terminal</p> <p>Part Numbers : EVPAJAC1A</p> 	     <p>Circuit Diagram</p> <p>* A or/and A' shall be used as common/ground terminal.</p> <p>Please do not Provide any Land pattern in this area.</p>  <p>Push plate side</p> <p>PWB land pattern for reference(View from mounting side)</p>
<p><b>EVPAJ</b></p> <p>L-shape</p> <p>Part Numbers : EVPAJAE1A</p> 	     <p>Circuit Diagram</p> <p>* A or/and A' shall be used as common/ground terminal.</p> <p>Please do not Provide any Land pattern in this area.</p>  <p>Push plate side</p> <p>PWB land pattern for reference(View from mounting side)</p>

# Panasonic

## Light Touch Switches/EVPAJ

### Recommended Reflow Soldering Conditions

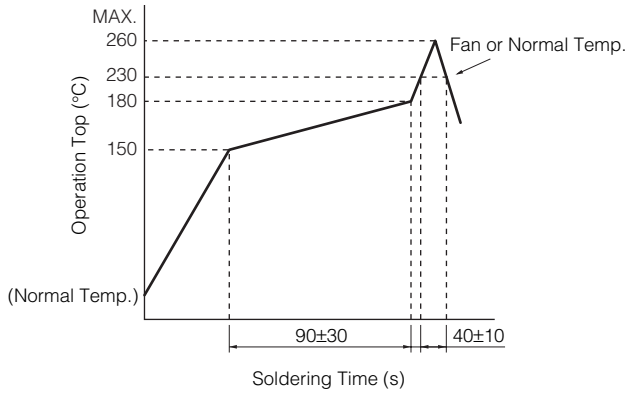

### Embossed Carrier Taping

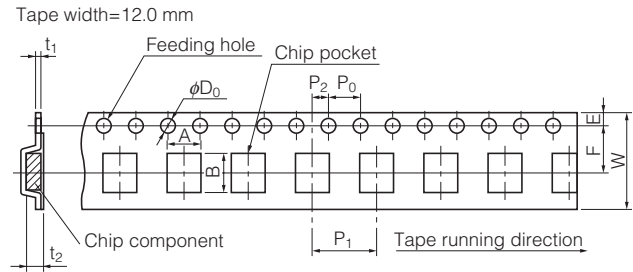

Unit: mm

Part No.	Height	A	B	W	F	E	P <sub>1</sub>	P <sub>2</sub>	P <sub>0</sub>	D <sub>0</sub> Dia.	t <sub>1</sub>	t <sub>2</sub>
EVPAJ	1.2	6.8±0.2	4.9±0.2	12.0 <sup>+0.3</sup> <sub>-0.1</sub>	5.78±0.1	1.75±0.1	8.0±0.1	2.0±0.1	4.0±0.1	1.5 <sup>+0.1</sup> <sub>-0</sub>	0.3±0.05	1.95 <sup>+0.3</sup> <sub>-0</sub>

### Standard Reel Dimensions in mm (not to scale)

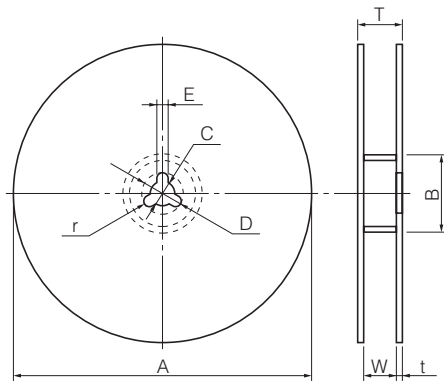

Item	A	B	C	D	E
Rate (mm)	φ380.0±2.0	φ80.0±1.0	φ13.0±0.5	φ21.0±1.0	2.0±0.5

Item	W	T	t	r
Rate (mm)	13.5±1.0	17.5±1.0	-	-