

Excellent Integrated System Limited

Stocking Distributor

Click to view price, real time Inventory, Delivery & Lifecycle Information:

[Molex Connector Corporation](#)
[0314081201](#)

For any questions, you can email us directly:

sales@integrated-circuit.com

10 | 9 | 8 | 7 | 6 | 5 | 4 | 3 | 2 | 31408

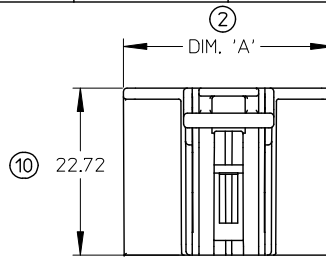
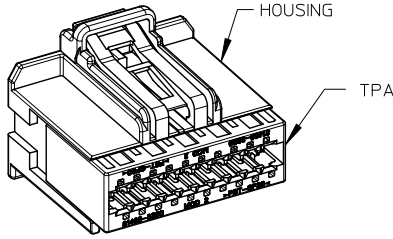

VIEW SHOWN WITH TPA IN LOCKED POSITION

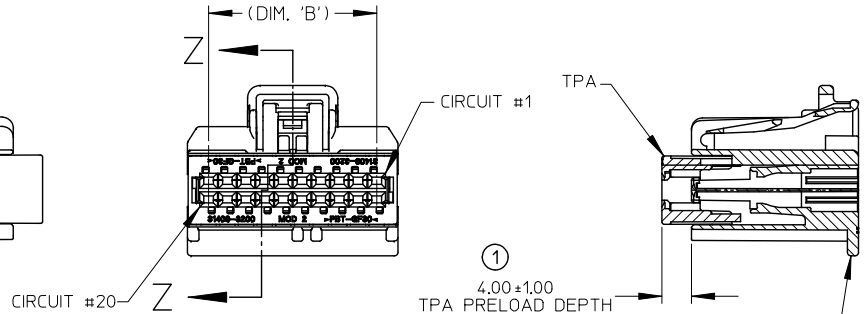
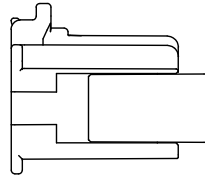

FRONT VIEW

SECTION Z-Z

NOTES:

1. MATERIALS:
HOUSING: SPS/PA66 BLEND, 30% GF
TPA: PBT, GF
COLOR: NATURAL (CREAM)
2. PACKAGING INFORMATION: PK-31300-044
3. MATING COMPONENTS:
NEW APPLICATIONS:
REFER TO SD-34691-100 & SD-34690-100
EXISTING APPLICATIONS (RESTRICTED):
REFER TO SD-31429-700 & SD-31411-700
4. TPA's MAY BECOME SEATED DURING TRANSIT. IF THIS OCCURS, REFERENCE MOLEX PRODUCT SPECIFICATION PS-34646-001.
5. TO BE USED WITH TYCO TERMINAL: 18/20 AWG 1393366-1
22 AWG 1393367-1

EC NO: UAU2015-0276 DRWN: JFISCHERO 2014/08/13 CHKD: APPR: RBAUMAN 2014/08/19 REV: G1	QUALITY SYMBOLS	GENERAL TOLERANCES (UNLESS SPECIFIED)		SCALE 2:1	DESIGN UNITS METRIC	THIRD ANGLE PROJECTION	REVISE ON CAD ONLY
	▽ 0 ∇ 0		mm	INCH	DIMENSION STYLE MM ONLY		TITLE USCAR 0.64MM RECEPTACLE ASSY, GET TERMINAL SALES DRAWING
		4 PLACES	± .005	± .0004	DRAWN BY SKAROLEW	DATE 2004/02/17	
		3 PLACES	± .008	± .0005	CHECKED BY MDANIELS	DATE 2004/03/31	MATERIAL NO.
2 PLACES	± 0.13	± .005	APPROVED BY BBWILSON	DATE 2004/04/06	DOCUMENT NO. SD-31408-900	SHEET NO. 1 OF 3	
		1 PLACE	± 0.25	± .005	DRAFT WHERE APPLICABLE MUST REMAIN WITHIN DIMENSIONS THIS DRAWING CONTAINS INFORMATION THAT IS PROPRIETARY TO MOLEX INCORPORATED AND SHOULD NOT BE USED WITHOUT WRITTEN PERMISSION		

8 | 7 | 6 | 5 | 4 | 3 | 2 | 1

10 | 9 | 8 | 7 | 6 | 5 | 4 | 3 | 2 | 31408

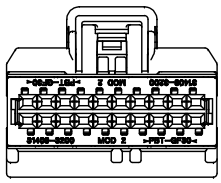

20 WAY

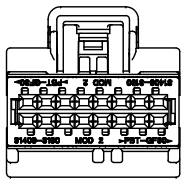

16 WAY

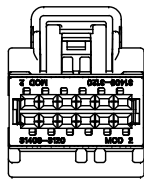

12 WAY

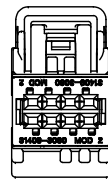

8 WAY

POLARIZATION 'A' OPTION
(ALL CIRCUITS SHOWN)

PROBE HOLE LOCATIONS

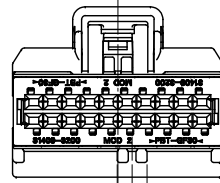
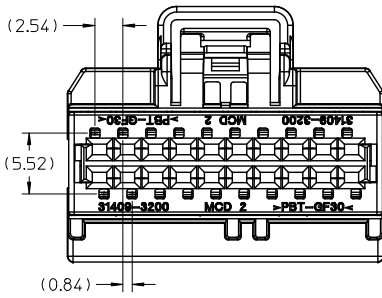

POLARIZATION 'A'

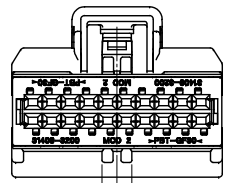

POLARIZATION 'B'

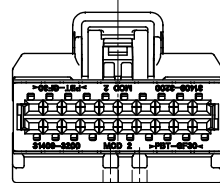

POLARIZATION 'C'

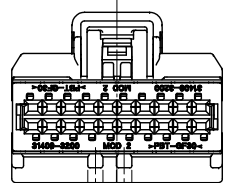

POLARIZATION 'D'

POLARIZATION OPTIONS
(20-CIRCUIT SHOWN)

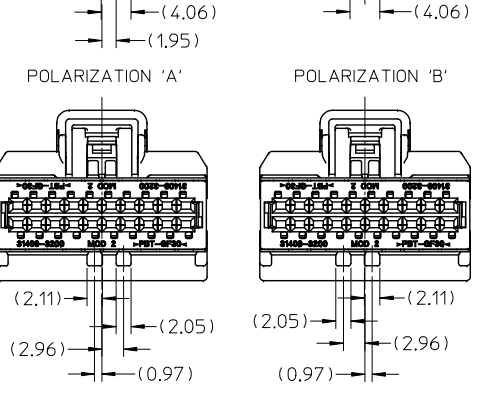

EC NO: UAU2015-0276 DRWN: FISCHERO 2014/08/13 CHKD: APPR: BAUMAN 2014/08/19 G1	QUALITY SYMBOLS ▽-0 ▽-0	GENERAL TOLERANCES (UNLESS SPECIFIED)		SCALE 2:1	DESIGN UNITS METRIC	THIRD ANGLE PROJECTION	REVISE ON CAD ONLY
		DIMENSION STYLE MM ONLY	DRAWN BY SKAROLEW 2004/02/17 CHECKED BY MDANIELS 2004/03/31 APPROVED BY BBWILSON 2004/04/06	DATE	TITLE USCAR 0.64MM RECEPTACLE ASSY, GET TERMINAL SALES DRAWING	MATERIAL NO. SEE CHART DOCUMENT NO. SD-31408-900 SHEET NO. 2 OF 3	
DRAFT WHERE APPLICABLE MUST REMAIN WITHIN DIMENSIONS		ANGULAR ± 3°		MOLEX INCORPORATED			
THIS DRAWING CONTAINS INFORMATION THAT IS PROPRIETARY TO MOLEX INCORPORATED AND SHOULD NOT BE USED WITHOUT WRITTEN PERMISSION							

8 | 7 | 6 | 5 | 4 | 3 | 2 | 1

10 9 8 7 6 5 4 3 2 31408

MOLEX ASSY. P/N	CIRCUITS	DIM. 'A'	(DIM. 'B')	(DIM. 'C')	POLARIZATION	HOUSING COLOR
31408-1080	8	13.40	(7.62)	(29.7)	A	BLACK
31408-1081					B	GRAY
31408-1082					C	BROWN
31408-1120	12	18.48	(12.70)	(31.3)	A	BLACK
31408-1121					B	GRAY
31408-1122					C	BROWN
31408-1160	16	23.56	(17.78)	(33.5)	A	BLACK
31408-1161					B	GRAY
31408-1162					C	BROWN
31408-1200	20	28.64	(22.86)	(36.3)	A	BLACK
31408-1201					B	GRAY
31408-1202					C	BROWN
31408-1203					D	GREEN



RECYCLE CODE
P/N SERIES NO.
MANU. LOC./CAV. ID

DETAIL Y
SCALE 4:1

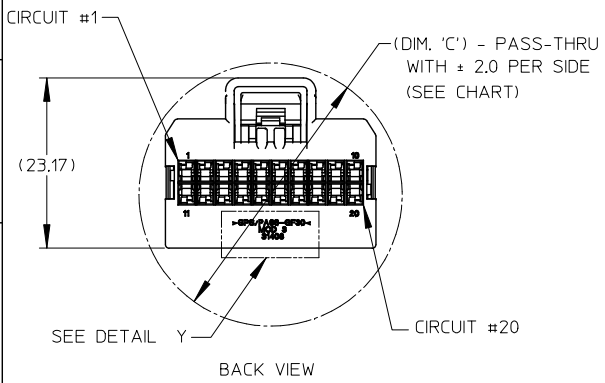

EC NO: UAU2015-0276 DRWN: FISCHERO 2014/08/13 CHKD: APPERBAUMAN 2014/08/19 REV: G1	QUALITY SYMBOLS ▽-0 ▽-0	GENERAL TOLERANCES (UNLESS SPECIFIED)		SCALE 2:1	DESIGN UNITS METRIC	THIRD ANGLE PROJECTION	REVISE ON CAD ONLY
		4 PLACES ± .13	3 PLACES ± .13	2 PLACES ± 0.13	1 PLACE ± 0.25	MM ONLY	TITLE USCAR 0.64MM RECEPTACLE ASSY, GET TERMINAL SALES DRAWING
DRAFT WHERE APPLICABLE MUST REMAIN WITHIN DIMENSIONS		ANGULAR ± 3°		DRAWN BY SKAROLEW 2004/02/17	CHECKED BY MDANIELS 2004/03/31	MATERIAL NO. SEE CHART DOCUMENT NO. SD-31408-900 SHEET NO. 3 OF 3	
THIS DRAWING CONTAINS INFORMATION THAT IS PROPRIETARY TO MOLEX INCORPORATED AND SHOULD NOT BE USED WITHOUT WRITTEN PERMISSION							

8 7 6 5 4 3 2 1