

Excellent Integrated System Limited

Stocking Distributor

Click to view price, real time Inventory, Delivery & Lifecycle Information:

[Molex Connector Corporation](#)
[0354076202](#)

For any questions, you can email us directly:

sales@integrated-circuit.com

PROJECT NO. 35407-002
 SIMILAR ITEM
 PROJECT NO.
 E
 D
 C
 B
 DO NOT SCALE DRAWING DIMENSION IN METRIC

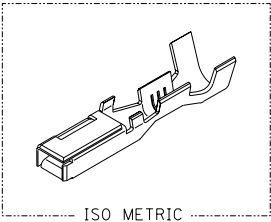

ISO METRIC

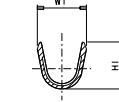
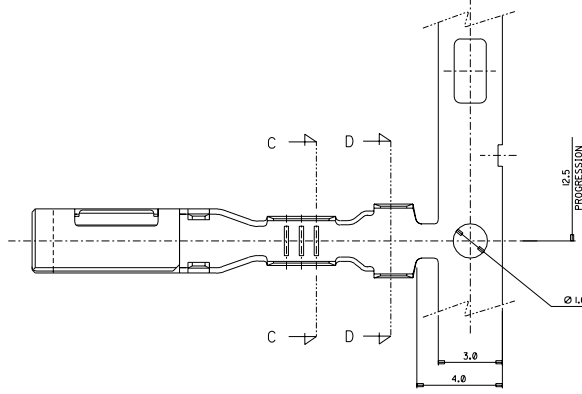

SECTION: C-C

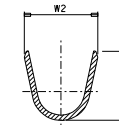

SECTION: D-D

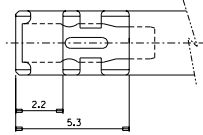
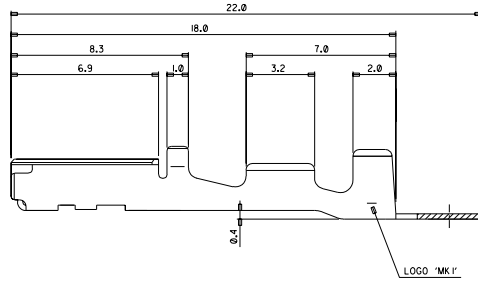
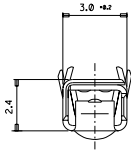

NOTE

1. MATERIAL: COPPER ALLOY, $t=0.25$.
2. FINISH: PRE-TIN PLATE.
3. RECOMMENDED LENGTH OF WIRE STRIP: 5.0-5.6.
4. INSERTION-EXTRACTION FORCE WITH TAB TERMINAL P/N 35420.
 INSERTION FORCE : 0.30 ± 1.0 Kgf.
 AFTER SIX TIMES OF INSERTION & EXTRACTION FORCE : 0.15 ± 1.0 Kgf.

NO.	ENG-NO.	TYPE	PART NAME	CABLE SIZE (mm ²)	DIMENSION			
					W1	H1	W2	H2
1	35407-6102	IS1	.090 FEMALE TER'L	AVSSIAVS1 0.3 - 0.5	2.5	2.4	3.4	3.5
2	35407-6202	IL1	.090 FEMALE TER'L	AVSSIAVS1 2.0	3.6	3.5	4.0	4.0
3	35407-6502	IM1	.090 FEMALE TER'L	AVSSIAVS1 0.85 - 1.25	2.6	3.0	4.0	4.0

CHANGED TENSION SPEC. EC INC. 4/04/02-0030 DIMMS:AKHM 02/27/08 DIMMS:AKHM 02/27/08	QUALITY SYMBOLS MAJOR: ▽ CRITICAL: ▽ REVISION: C	GENERAL TOLERANCES: (UNLESS SPECIFIED): 4 PLACES .30. ±. 3 PLACES .30. ±. 2 PLACES .30. ±. 1 PLACE .30.25 ±. ANGULAR: ± 1°	SCALE: 8:1 DESIGN UNITS: 8:1 DRAWN BY & DATE: B.C.YOON '98.4.10 CHECKED BY & DATE: B.C.HOI '98.4.10 APPROVED BY & DATE: C.W.LEE '98.4.10 CAD FILENAME: 5035407.DGN	THIRD ANGLE PROJECTION TITLE: .090 FEMALE TER'L (FT TYPE) MOLEX INCORPORATED	DIMENSIONS: DIM INCH DIM MM DIM INCH DIM MM	SHEET NO. 1 OF 1 SIZE C MX-A2
		DRAFT WHERE APPLICABLE MUST REMAIN WITHIN DIMENSIONS				
		THIS DRAWING CONTAINS INFORMATION THAT IS PROPRIETARY TO MOLEX INCORPORATED AND SHOULD NOT BE USED WITHOUT WRITTEN PERMISSION.				

11 10 9 8 7 6 5 4 3 2 1