

## **Excellent Integrated System Limited**

Stocking Distributor

Click to view price, real time Inventory, Delivery & Lifecycle Information:

[Molex Connector Corporation](#)  
[0355330215](#)

For any questions, you can email us directly:  
[sales@integrated-circuit.com](mailto:sales@integrated-circuit.com)

10 9 8 7 6 5 4 3 2 1

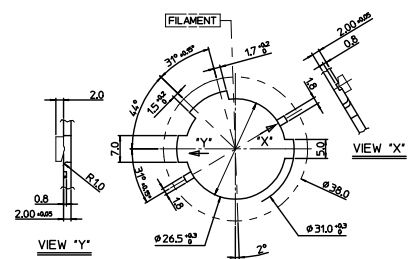
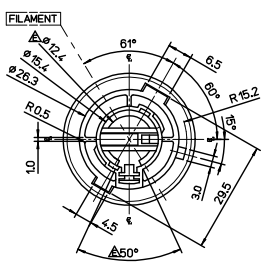
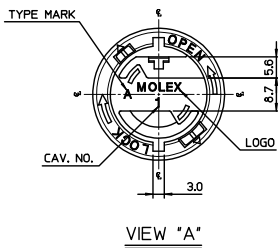

MOUNTING INTERFACE (MI-11)

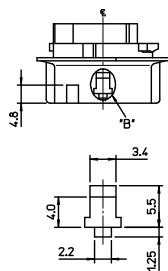
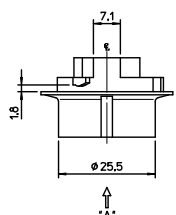
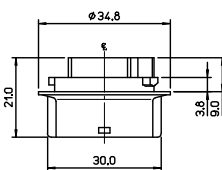

DETAIL 'B' SCALE 2:1

- NOTES  
 1. FOCAL LENGTH = 31.8mm  
 2. APPLICABLE BULB CAP: P21W(BA15s)  
 3. MATES WITH

NO.	DESCRIPTION	MATERIAL	ORDER NO.	REMARK
②	POSITIVE TERMINAL	PHOSPHOR BRONZE	35438-8000	UNPLATED
③	EARTH TERMINAL	PHOSPHOR BRONZE	35439-8000	UNPLATED

<PART LIST>

NO.	DESCRIPTION	MATERIAL	USAGE	REMARK
①	SINGLE SOCKET	PA66	1	A TYPE

<TABLE 1>

MATERIAL NO.	ORDER NO.	COLOR
355330200	35533-0200	NATURAL
355330205	35533-0205	GRAY
355330206	35533-0206	WHITE

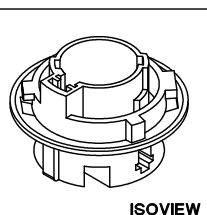
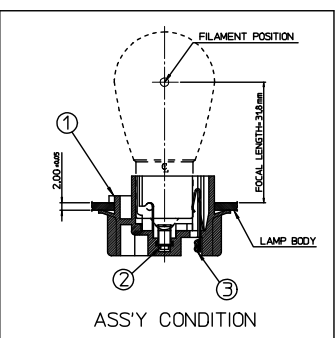

REVISED  
 EC NO: KTR2015-0097  
 DRAWN: YBAEK 2015/04/24  
 CHKD: JYCHOI  
 APPR: JYCHOI 2015/05/04

QUALITY SYMBOLS  
 ▼=0  
 ▽=0

GENERAL TOLERANCES (UNLESS SPECIFIED)

	mm	INCH
4 PLACES	± ---	± ---
3 PLACES	± ---	± ---
2 PLACES	± 0.2	± ---
1 PLACE	± 0.3	± ---
ANGULAR ± 3°		

DRAFT WHERE APPLICABLE MUST REMAIN WITHIN DIMENSIONS

DIMENSION STYLE  
 MM ONLY

DRAWN BY	DATE	TITLE
JSKANG	1998/01/31	NON-SEALED BULB SOCKET SINGLE HOUSING ASS'Y (A-TYPE)
CHECKED BY	DATE	
BKCHOI	1998/01/31	
APPROVED BY	DATE	
CWLEE	1998/01/31	

MATERIAL NO.	ORDER NO.	COLOR
355330200	35533-0200	NATURAL
355330205	35533-0205	GRAY
355330206	35533-0206	WHITE

DESIGN UNITS METRIC  
 THIRD ANGLE PROJECTION

MOLEX INCORPORATED  
 SD-35533-001  
 SHEET NO. 1 OF 1

9 8 7 6 5 4 3 2 1