

Excellent Integrated System Limited

Stocking Distributor

Click to view price, real time Inventory, Delivery & Lifecycle Information:

[Molex Connector Corporation](#)
[0190730116](#)

For any questions, you can email us directly:

sales@integrated-circuit.com

NOTES:

- ① MAT'L: COPPER (STOCK TKN. $\frac{.040}{1.02}$)
- ② PLATING: ELECTRO TIN (.0003 MIN)
- ③ TIN-PLATED BRASS FUNNEL FERRULE
- ④ NYLON INSULATION (COLOR CODED YELLOW)

STUD SIZES: ($\pm .005$)

02 = .094	413 = 413
04 = .119	
06 = .146	
08 = .173	
10 = .198	
14 = .265	
56 = .328	
38 = .390	
209 = .209	

"UL" LISTING # E32244
 "CSA" LISTING # 18689

WIRE SIZE: 12 - 10 AWG
 4.0 - 6.0 MM²

ALL DIMENSIONS = $\frac{\text{INCHES}}{\text{MM}}$ (MWID) = DENOTES MAXIMUM WIRE INSULATION DIAMETER

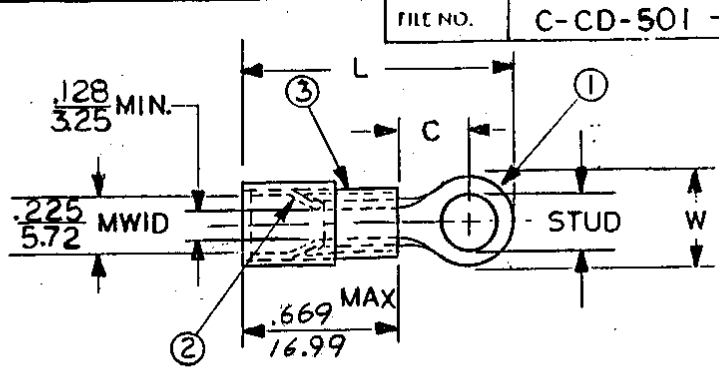

FILE NO. C-CD-501-01

PART NUMBER	"W" $\pm .010$	"C" MIN.	"L" MAX.	AVAILABLE STUD SIZES			
C-501-	$\frac{.750}{19.05}$	$\frac{.611}{15.52}$	$\frac{1.700}{43.18}$	14, 56, 38, 76, 12			
C-528-	$\frac{.375}{9.53}$	$\frac{.303}{7.70}$	$\frac{1.205}{30.61}$	04, 06, 08, 10, 209			
C-530-	$\frac{.530}{13.46}$	$\frac{.393}{9.98}$	$\frac{1.372}{34.85}$	10, 14, 56, 38			
C-536-	$\frac{.282}{7.16}$	$\frac{.306}{7.77}$	$\frac{1.161}{29.49}$	04, 06, 08			
C-540-	$\frac{.592}{15.04}$	$\frac{.466}{11.84}$	$\frac{1.476}{37.49}$	10, 14, 56, 38, 209, 413			

DIMENSIONAL TOLERANCES UNLESS OTHERWISE SPECIFIED			REFERENCE	SCALE: NTS	DATE	TITLE: RING TONGUE TERMINAL AVIKRIMP 500-SERIES	
			DRWN. BY: JJ	11-15-84			
			CHKD. BY: GZ	11-26-84			
			APPRD. BY:				
FRAC.	DEC.	ANG.				DWG. NO. A	CUSTOMER DWG