

Excellent Integrated System Limited

Stocking Distributor

Click to view price, real time Inventory, Delivery & Lifecycle Information:

[Molex Connector Corporation](#)

[0191930556](#)

For any questions, you can email us directly:

sales@integrated-circuit.com

10	9	8	7	6	5	4	3	2	19193	
MATERIAL NO.	ENG. NO.	STUD SIZE	±.003 "S"	STOCK THICKNESS						
191930330	H-381-14	1/4	.265	.075 (1.90)						
191930333	H-381-56	5/16	.328							
191930331	H-381-38	3/8	.390							
191930556	H-381-12	1/2	.515							

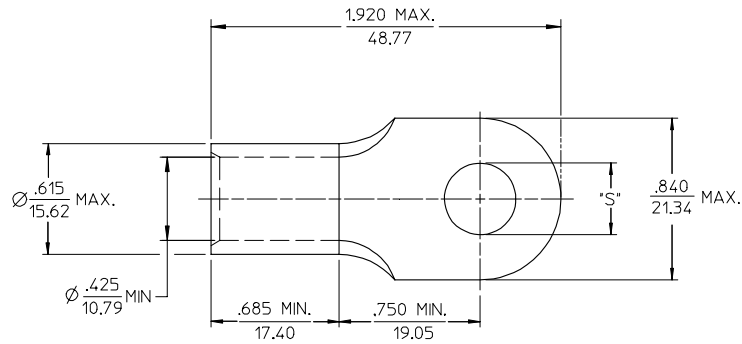

SALES DRAWING

- NOTE(S):
1. MATERIAL: COPPER
 2. PLATING: ELECTROPLATE TIN.
 3. ALL DIMENSIONS IN INCHES/(MM)
 4. WIRE SIZE: 1/0 AWG
50 MM²

REVISED/UPDATE TO MK STD EC NO. ETC2003-0315 DRAWN BY: RIEK 2003/08/20 CHKD: HEB 2003/08/21 APPR: RDEROSS 2003/08/21	QUALITY SYMBOLS -0 -0	GENERAL TOLERANCES (UNLESS SPECIFIED)		SCALE 2:1	DESIGN UNITS INCH	THIRD ANGLE PROJECTION	REVISE ON CAD ONLY	
		4 PLACES ± --- ± ---	3 PLACES ± --- ± .005	DIMENSION STYLE IN/MM		TITLE RING TONGUE TERMINAL VERSAKRIMP SERIES 1/0 AWG		
		2 PLACES ± 0.13 ± .01	1 PLACE ± 0.25 ± ---	DRAWN BY DLM	DATE 03/06/13	MOLEX INCORPORATED		
		ANGULAR ±1/2°		CHECKED BY HEB	DATE 03/06/13	MATERIAL NO. (SEE CHART)	DOCUMENT NO. SD-19193-020	SHEET NO. 1 OF 1
A	REV	DRAFT WHERE APPLICABLE MUST REMAIN WITHIN DIMENSIONS		APPROVED BY RWD	DATE 03/06/13	THIS DRAWING CONTAINS INFORMATION THAT IS PROPRIETARY TO MOLEX INCORPORATED AND SHOULD NOT BE USED WITHOUT WRITTEN PERMISSION		