

## Excellent Integrated System Limited

Stocking Distributor

Click to view price, real time Inventory, Delivery & Lifecycle Information:

[Molex Connector Corporation](#)  
[0534260910](#)

For any questions, you can email us directly:

[sales@integrated-circuit.com](mailto:sales@integrated-circuit.com)

10 9 8 7 6 5 4 3 2 1

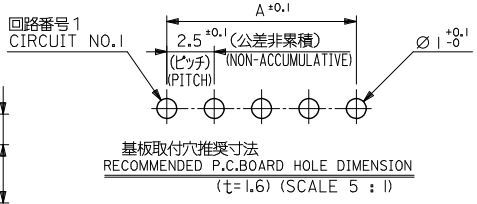
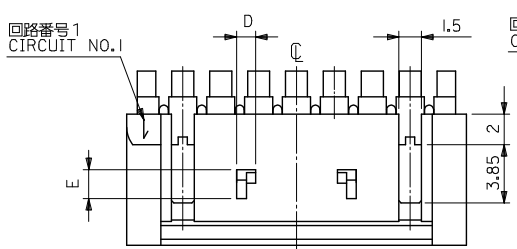

**注記 NOTES**

- △ 偶数極品に適用。 APPLIES ONLY TO EVEN NO. CKT. SIZES.
- 2. 嵌合相手: 51102,51103シリーズ MATES WITH: 51102,51103 SERIES.
- △ 2極はキンクを付加しない。 3極以上のキンク形状は両サイドが(B)、その他の極はすべて(A)形状とする。 KINK FORM MORE THAN 2 CIRCUIT: PINS AT BOTH ENDS ARE KINK FORMED TO (B), THE OTHER PINS ARE KINK FORMED TO (A).
- 4. 製品番号の下1桁は色を表します。 LAST DIGIT OF PART NUMBER INDICATES COLOR. 0:白 WHITE 2:赤 RED

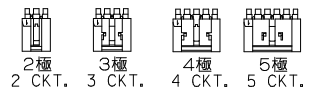
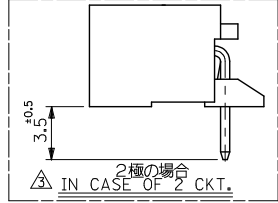
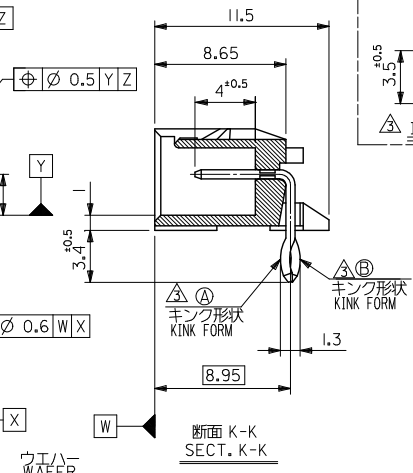
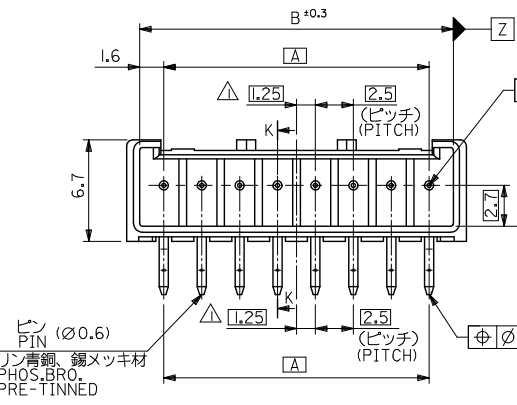

1.9	1.25	39.9	38.2	35		53426-1510	15	
		37.4	35.7	32.5		53426-1410	14	
		34.9	33.2	30		53426-1310	13	
		32.4	30.7	27.5		53426-1210	12	
		29.9	28.2	25		53426-1110	11	
		27.4	25.7	22.5		53426-1010	10	
		24.9	23.2	20		53426-0910	9	
		22.4	20.7	17.5		53426-0810	8	
		19.9	18.2	15		53426-0710	7	
		17.4	15.7	12.5		53426-0610	6	
		14.9	13.2	10		53426-0510	5	
	1.25	12.4	10.7	7.5	53426-0412	53426-0410	4	
1.9	1	9.9	8.2	5		53426-0310	3	
		7.4	5.7	2.5		53426-0210	2	
E	D	C	B	A		53426-***12 COLOR:RED	53426-***10 COLOR:WHITE	極数 NO. OF CKTS.

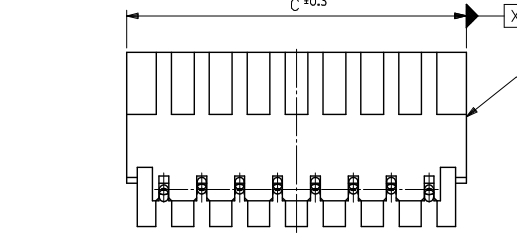

REVISED	EC NO. J2009-0576	2008/12/16	
	DRW:KANAKURA	2008/12/16	
	CHK:Y.HARIYAMA	2008/12/16	
	APP:Y.NIKITA	2009/01/19	
DESCRIPTION			
GENERAL TOLERANCES (UNLESS SPECIFIED)			
10 UNDER	±0.2		
10 OVER 30 UNDER	±0.25		
30 OVER	±0.3		
ANGULAR ±3°			
DRAFT WHERE APPLICABLE MUST REMAIN WITHIN DIMENSIONS			

DIMENSION STYLE		SCALE	DESIGN UNITS	MODEL NO.	
MM ONLY		4:1	METRIC	53426-***1*	
DRAWN BY		DATE	TITLE		
K. TOJO		1993/07/23	2.5 W/B CONN.WAFER ASSY		
CHECKED BY		DATE	RIGHT ANGLE WITH KINK		
K. ASAKAWA		2001/11/13	-LEAD FREE-		
APPROVED BY		DATE	MOLEX INCORPORATED		
T. YAMAGUCHI		2001/11/13	SEE CHART		
MATERIAL NO.		DOCUMENT NO.	SD-53426-001		
SIZE		THIS DRAWING CONTAINS INFORMATION THAT IS PROPRIETARY TO MOLEX INCORPORATED AND SHOULD NOT BE USED WITHOUT WRITTEN PERMISSION			
A3					
SHEET NO.		1 OF 1			