

Excellent Integrated System Limited

Stocking Distributor

Click to view price, real time Inventory, Delivery & Lifecycle Information:

[Molex Connector Corporation](#)
[0736510233](#)

For any questions, you can email us directly:

sales@integrated-circuit.com

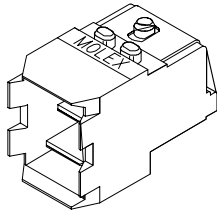
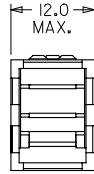
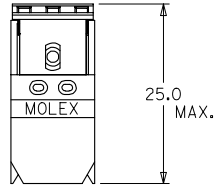
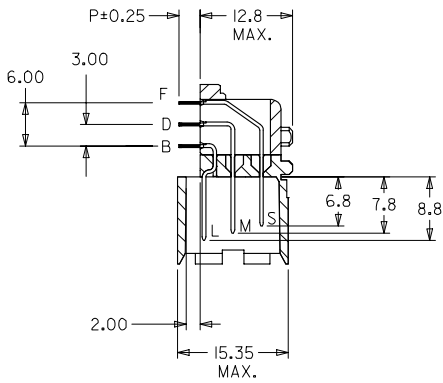

NOTES:

1. MATERIALS:

HOUSING - LIQUID CRYSTAL POLYMER (LCP), GLASS-FILLED, UL 94V-0, COLOR BLACK
TERMINAL - COPPER ALLOY

2. FINISH:

ASSEMBLIES WITH PRESSFIT TAILS:
0.76 MINIMUM SELECTIVE GOLD (Au) IN CONTACT AREA,
SELECTIVE TIN/LEAD (Sn/Pb) ON PC TAILS
OVER NICKEL (Ni) UNDERPLATE OVERALL.

ASSEMBLIES WITH SOLDER TAILS:
0.76 MINIMUM SELECTIVE GOLD (Au) IN CONTACT AREA,
SELECTIVE TIN (Sn) ON PC TAILS
OVER NICKEL (Ni) UNDERPLATE OVERALL.

3. THIS PART CONFORMS TO MOLEX PRODUCT SPECIFICATION PS-73670-9999.

4. THIS DIMENSION MUST BE A MULTIPLE OF 4.00mm.

5. DIMENSIONS ARE IN MILLIMETERS AND ARE FOR LAYOUT PURPOSES ONLY.

6. DIMENSIONS AND TOLERANCES SUBJECT TO CHANGE WITHOUT NOTICE.

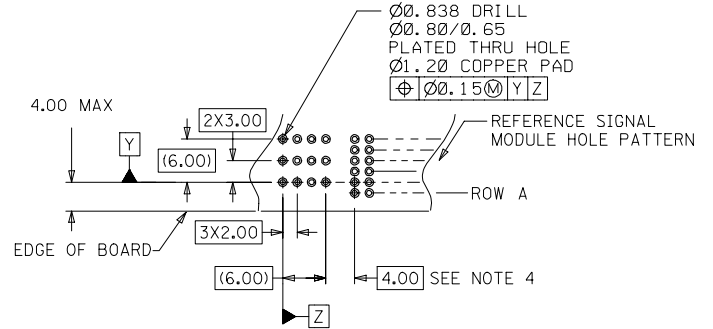

PCB LAYOUT: COMPONENT SIDE
RECOMMENDED PCB THICKNESS: 1.60 MIN
(FOR SOLDER TAIL AND PRESS FIT)

MODIFY FINISH EC NO: UCP2007-1348 TIDRWINS BARBA 2006/12/28 CHYKD-BARKER 2007/01/04 APPR: SHILLER 2007/01/05 REV DESCRIPTION	QUALITY SYMBOLS	GENERAL TOLERANCES (UNLESS SPECIFIED) <table border="1"> <tr> <td></td> <td>mm</td> <td>INCH</td> </tr> <tr> <td>4 PLACES</td> <td>±0.10</td> <td>±0.004</td> </tr> <tr> <td>3 PLACES</td> <td>±0.15</td> <td>±0.006</td> </tr> <tr> <td>2 PLACES</td> <td>±0.20</td> <td>±0.008</td> </tr> <tr> <td>1 PLACE</td> <td>±0.25</td> <td>±0.010</td> </tr> <tr> <td colspan="3">ANGULAR ±1/2°</td> </tr> </table>		mm	INCH	4 PLACES	±0.10	±0.004	3 PLACES	±0.15	±0.006	2 PLACES	±0.20	±0.008	1 PLACE	±0.25	±0.010	ANGULAR ±1/2°			DIMENSION STYLE MM ONLY	SCALE 2:1	DESIGN UNITS METRIC	THIRD ANGLE PROJECTION
			mm	INCH																				
	4 PLACES		±0.10	±0.004																				
	3 PLACES		±0.15	±0.006																				
2 PLACES	±0.20	±0.008																						
1 PLACE	±0.25	±0.010																						
ANGULAR ±1/2°																								
DRAWN BY JRP DATE 199/07/22 CHECKED BY PAR DATE 1996/07/22 APPROVED BY LAB DATE 1996/07/22	MATERIAL NO. SEE SHEET 2 SIZE B	TITLE SALES ASSEMBLY HDM DAUGHTERCARD POWER MODULE MOLEX INCORPORATED DOCUMENT NO. SDA-73651-****	SHEET NO. 1 OF 2																					
DRAFT WHERE APPLICABLE MUST REMAIN WITHIN DIMENSIONS		THIS DRAWING CONTAINS INFORMATION THAT IS PROPRIETARY TO MOLEX INCORPORATED AND SHOULD NOT BE USED WITHOUT WRITTEN PERMISSION																						
ib_Frame_B_P_AM_T Rev. E 2006/04/15																								

MATERIAL NUMBER ASSIGNMENT

TAIL TYPE

0 = SOLDER
1 = PRESS FIT

73651- * * * *

PC TAIL LENGTH

CODE	DIM 'P'
0	= 2.00
1	= 2.50
2	= 3.00
3	= 3.50
4	= 4.00
5	= 2.75

PRESSFIT TAILS AVAILABLE IN THESE LENGTHS ONLY

MATING LENGTH

10 = SSS	20 = MSS	30 = LSS
11 = SSM	21 = MSM	31 = LSM
12 = SSL	22 = MSL	32 = LSL
13 = SMS	23 = MMS	33 = LMS
14 = SMM	24 = MMM	34 = LMM
15 = SML	25 = MML	35 = LML
16 = SLS	26 = MLS	36 = LLS
17 = SLM	27 = MLM	37 = LLM
18 = SLL	28 = MLL	38 = LLL

DIM. 'P' ±0.25

MATING LENGTH EXAMPLES

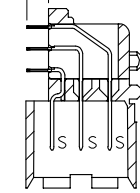

73651-XX10
TYPE SSS

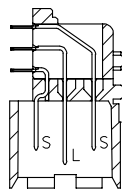

73651-XX16
TYPE SLS

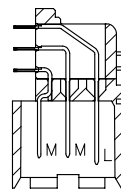

73651-XX25
TYPE MML

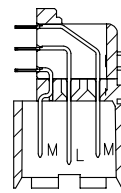

73651-XX27
TYPE MLM

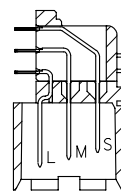

73651-XX33
TYPE LMS

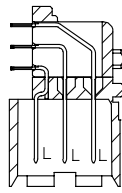

73651-XX38
TYPE LLL

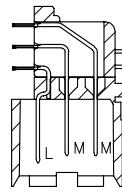

73651-XX34
TYPE LMM

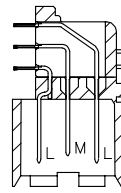

73651-XX35
TYPE LML

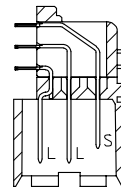

73651-XX36
TYPE LLS

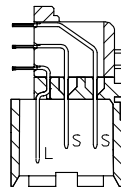

73651-XX30
TYPE LSS

UPDATE BORDER EC NO. UCP2007-1348 TIDRW:MS BARBA 2006/12/28 CHKCD:BARBER 2007/01/04 APPR:SPILLER 2007/01/05	QUALITY SYMBOLS ▽=0 ▽=0	GENERAL TOLERANCES (UNLESS SPECIFIED)		DIMENSION STYLE MM ONLY	SCALE 2:1	DESIGN UNITS METRIC	THIRD ANGLE PROJECTION		
		4 PLACES ±--- ±--- 3 PLACES ±--- ±--- 2 PLACES ±0.10 ±--- 1 PLACE ±0.25 ±---	mm INCH	DRAWN BY JRP	DATE 199/07/22	TITLE SALES ASSEMBLY HDM DAUGHTERCARD POWER MODULE			
		ANGULAR ±1/2°	DRAFT WHERE APPLICABLE MUST REMAIN WITHIN DIMENSIONS	APPROVED BY PAR	DATE 1996/07/22	MOLEX INCORPORATED			
		MATERIAL NO. SEE CHART	SIZE B	THIS DRAWING CONTAINS INFORMATION THAT IS PROPRIETARY TO MOLEX INCORPORATED AND SHOULD NOT BE USED WITHOUT WRITTEN PERMISSION		DOCUMENT NO. SDA-73651-****	SHEET NO. 2 OF 2		

MATERIAL NUMBER ASSIGNMENT

TAIL TYPE
0 = SOLDER
1 = PRESS FIT

73651- * * * *

PC TAIL LENGTH

CODE	DIM "P"
0	2.00
1	2.50
2	3.00
3	3.50
4	4.00
5	2.75

PRESSFIT TAILS AVAILABLE IN THESE LENGTHS ONLY

MATING LENGTH

10 = SSS	20 = MSS	30 = LSS
11 = SSM	21 = MSM	31 = LSM
12 = SSL	22 = MSL	32 = LSL
13 = SMS	23 = MMS	33 = LMS
14 = SMM	24 = MMM	34 = LMM
15 = SML	25 = MML	35 = LML
16 = SLS	26 = MLS	36 = LLS
17 = SLM	27 = MLM	37 = LLM
18 = SLL	28 = MLL	38 = LLL

DIM. "P" ±0.25

MATING LENGTH EXAMPLES

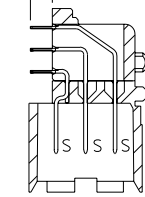

73651-XX10
TYPE SSS

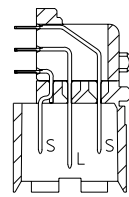

73651-XX16
TYPE SLS

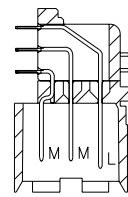

73651-XX25
TYPE MML

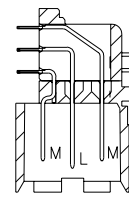

73651-XX27
TYPE MLM

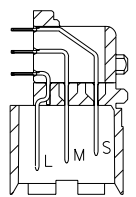

73651-XX33
TYPE LMS

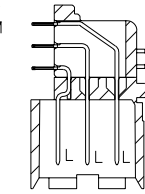

73651-XX38
TYPE LLL

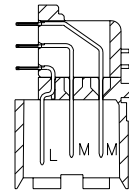

73651-XX34
TYPE LMM

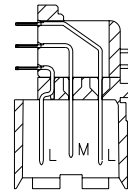

73651-XX35
TYPE LML

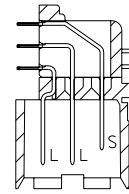

73651-XX36
TYPE LLS

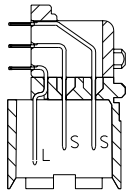

73651-XX30
TYPE LSS

DIMENSIONS SHOWN (METRIC) INCH

UNLESS OTHERWISE SPECIFIED TOLERANCES: ANGULAR ± 1/2°

	INCH	METRIC
3 PLACE	± N/A	---
2 PLACE	± N/A	± ---
1 PLACE	---	± ---

DRAFT WHERE APPLICABLE MUST REMAIN WITHIN DIMENSIONS

DRWG. BY: JRR CHK'D. BY: SMR
APP'D. BY: CAB SCALE: 2 : 1

REVISIONS: 0 = 0 REVISION ONLY ON CAD SYSTEM

TITLE: SALES ASSY, HDM DAUGHTER CARD POWER MODULE

PART NO. MOLEX INCORPORATED 1151EJLL 68532 SHEET NO. 2 DATE 96/07/22 U.S.A.

SEE CHART DRWG. NO. SDA-73651-**** THIS DRAWING CONTAINS INFORMATION THAT IS PROPRIETARY TO MOLEX INC. AND SHOULD NOT BE USED WITHOUT WRITTEN PERMISSION. DIV. DA SIZE B

10 9 8 7 6 5 4 3 2 1