

## Excellent Integrated System Limited

Stocking Distributor

Click to view price, real time Inventory, Delivery & Lifecycle Information:

[Molex Connector Corporation](#)  
[0879209120](#)

For any questions, you can email us directly:

[sales@integrated-circuit.com](mailto:sales@integrated-circuit.com)

10 9 8 7 6 5 4 3 2 1

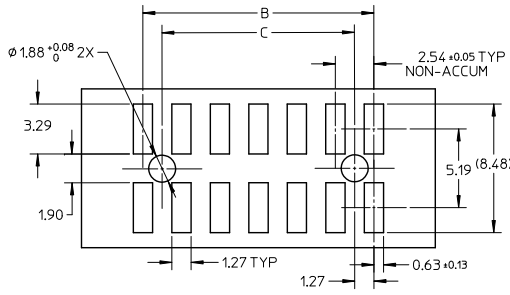
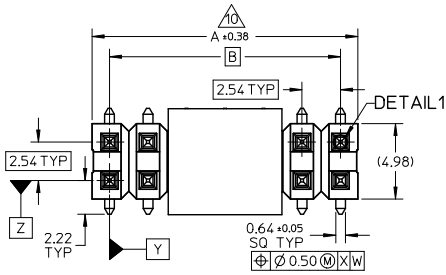

RECOMMENDED PCB LAYOUT

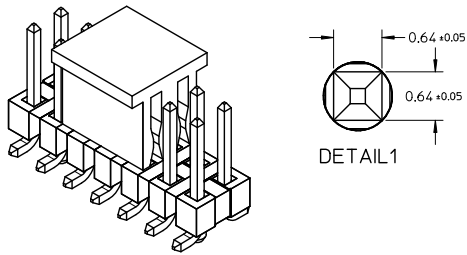
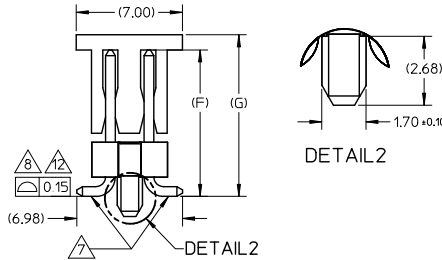
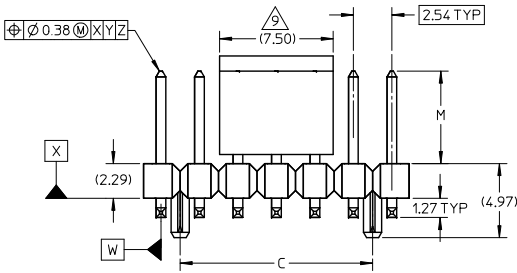

NOTES:

- MATERIAL:  
HSG: LCP, GLASS-FILLED, UL94V-0, COLOR: BLACK  
CAP: NYLON, GLASS-FILLED, UL94V-0, COLOR: BLACK  
PIN: 0.64MM SQ, COPPER ALLOY
- PLATING TYPE:  
(1) 0.38µm MIN. GOLD PLATE ON CONTACT AND 2.00µm MIN. TIN ON SOLDER TAIL OVER 1.25µm MIN. NICKEL OVERALL.  
(2) 0.75µm MIN. GOLD PLATE ON CONTACT AND 2.00µm MIN. TIN ON SOLDER TAIL OVER 1.25µm MIN. NICKEL OVERALL.  
(3) 2.50µm MIN. TIN OVERALL 1.25µm MIN. NICKEL OVERALL
- PACKAGING TYPE: SEE TABLE
- PCB THICKNESS 1.60+/-0.10mm
- PRODUCT SPECIFICATION: PS-87920-019
- WAFER TO BE FLAT WITHIN 0.003 mm/mm
- BEND DEPRESSION IS ACCEPTED SO LONG AS IT DOES NOT AFFECT THE OVERALL COPLANARITY OF TAIL
- COPLANARITY IS TO BE MEASURED BY RESTING THE SOLDER TAIL ON A FLAT SURFACE
- CAP LOCATION IS CENTERED ALONG THE MATING ENDS AS SHOWN. TOP SURFACE OF CAP TO BE FLAT FOR THE PURPOSE OF PICK & PLACE BY VACUUM SUCTION NOZZLE
- IRREGULAR CIRCUIT CUTOFF WITHIN BREAKAWAY SECTION IS PERMISSIBLE. CUTTING OR CHIPPING OF THE MAIN BODY IS NOT ACCEPTABLE
- PARTS ARE NOT STACKABLE ON 2.54 CENTER
- COPLANARITY FOR SIZES UP TO 40 IS 0.15MM.
- THE ABOVE CKT 14 IS FOR ILLUSTRATION PURPOSE ONLY
- TUBE LENGTH IS 560MM PER STANDARD
- CKT 4 & 6 TO BE PACKED IN BULK/TRAY PACKING
- PACKAGING SPECIFICATION: TUBE: PK-89990-478  
TAPE & REEL : PK-89990-479

ADD P/N: 87920-9120 EC NO.: S2011-0043 DRW:SKANG 2010/07/14 CHK:ATSEE 2010/08/02 APPR:MLONG 2010/08/03 REV D6	QUALITY SYMBOLS	GENERAL TOLERANCES (UNLESS SPECIFIED)	DIMENSION STYLE	SCALE	DESIGN UNITS	THIRD ANGLE PROJECTION																		
	$\nabla=0$ $\nabla=0$ $\nabla=0$	<table border="1"> <tr> <th></th> <th>mm</th> <th>INCH</th> </tr> <tr> <td>4 PLACES</td> <td>±---</td> <td>±---</td> </tr> <tr> <td>3 PLACES</td> <td>±---</td> <td>±---</td> </tr> <tr> <td>2 PLACES</td> <td>±0.2</td> <td>±---</td> </tr> <tr> <td>1 PLACE</td> <td>±---</td> <td>±---</td> </tr> <tr> <td colspan="3">ANGULAR ± 3°</td> </tr> </table>		mm	INCH	4 PLACES	±---	±---	3 PLACES	±---	±---	2 PLACES	±0.2	±---	1 PLACE	±---	±---	ANGULAR ± 3°			MM ONLY	NTS	METRIC	
		mm	INCH																					
	4 PLACES	±---	±---																					
3 PLACES	±---	±---																						
2 PLACES	±0.2	±---																						
1 PLACE	±---	±---																						
ANGULAR ± 3°																								
DRAWN BY SKL IM01 CHECKED BY PATEY APPROVED BY MLONG DATE 2006/02/09 DATE 2006/02/16 DATE 2010/02/08	DRAFT WHERE APPLICABLE MUST REMAIN WITHIN DIMENSIONS	MATERIAL NO. SEE TABLE SIZE $\Delta 3$ THIS DRAWING CONTAINS INFORMATION THAT IS PROPRIETARY TO MOLEX INCORPORATED AND SHOULD NOT BE USED WITHOUT WRITTEN PERMISSION	TITLE CUSTOM HEADER 2.54MM PITCH DUAL ROW HEADER SINGLE WAFER SMT MOLEX INCORPORATED DOCUMENT NO. SD-87920-020 SHEET NO. 1 OF 11																					

9 8 7 6 5 4 3 2 1

10 9 8 7 6 5 4 3 2 1

CIRCUITS POSITION CONFIGURATION

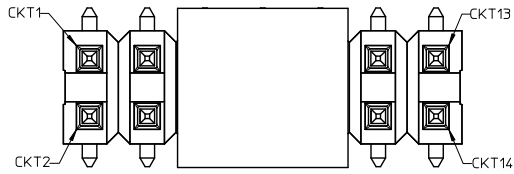

PART PACKED IN TUBE ORIENTATION

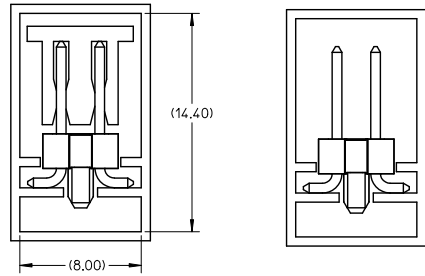

PART WITH PEGS WITH CAP IN TUBE

PART WITH PEGS WITHOUT CAP IN TUBE

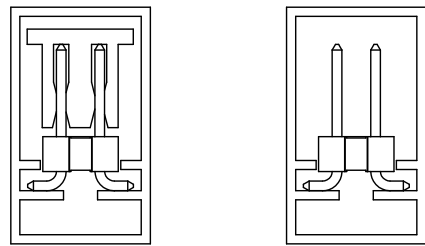

PART WITHOUT PEGS WITH CAP IN TUBE

PART WITHOUT PEGS WITHOUT CAP IN TUBE

ADD P/N: 87920-9120 EC NO: S2011-0043 DRAWN: SKANG CHK: DATSEE APPR: MLONG 2010/07/14 2010/08/02 2010/08/03	QUALITY SYMBOLS √=0 √=0 √=0	GENERAL TOLERANCES (UNLESS SPECIFIED)		DIMENSION STYLE MM ONLY		SCALE NTS	DESIGN UNITS METRIC	THIRD ANGLE PROJECTION	
		4 PLACES ± --- ± ---	3 PLACES ± --- ± ---	DRAWN BY SKLIM01	DATE 2006/02/09	TITLE CUSTOM HEADER 2.54MM PITCH DUAL ROW HEADER SINGLE WAFER SMT			
		2 PLACES ± 0.2 ± ---	1 PLACE ± --- ± ---	CHECKED BY PATEY	DATE 2006/02/16	MOLEX INCORPORATED			
		ANGULAR ± 3°		APPROVED BY MLONG	DATE 2010/02/08	MATERIAL NO. SEE TABLE	DOCUMENT NO. SD-87920-020	SHEET NO. 2 OF 11	
D6	REV	DRAFT WHERE APPLICABLE MUST REMAIN WITHIN DIMENSIONS		THIS DRAWING CONTAINS INFORMATION THAT IS PROPRIETARY TO MOLEX INCORPORATED AND SHOULD NOT BE USED WITHOUT WRITTEN PERMISSION					

9 8 7 6 5 4 3 2 1

10 9 8 7 6 5 4 3 2 1

CKT	F	P1	W
04	7.50	12.00	16.00

THIS TYPE OF CARRIER TAPE IS FOR CKT SIZE 04 ONLY

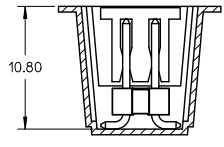
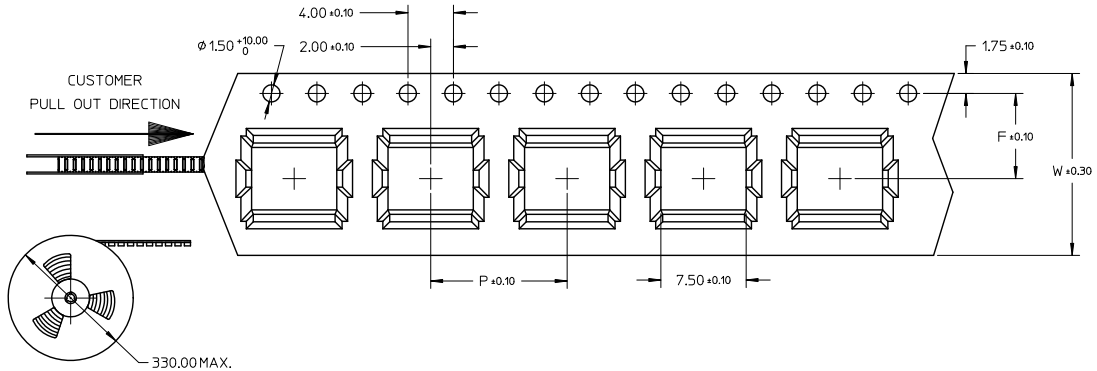

NOTES:

1. LEADER AND TRAILER TAPE

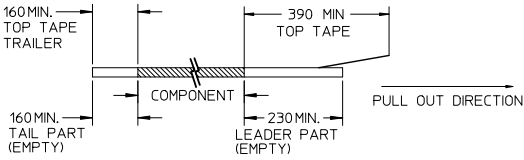

2. PEELING OFF FORCE OF THE TOP TAPE: 20-80gf.

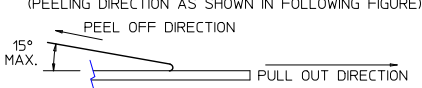

- 3. PACKAGING STANDARD IS AS PER EIA-481.
- 4. TAPE & REEL QUANTITY = 500 PCS/REEL
- 5. THE TAPE IS TREATED FOR ANTI-STATIC.

ADD P/N: 87920-9120 EC NO.: S2011-0043 DRAWN BY: DRWNSKANG CHKD BY: CHYKATSEE APPR: MLONG 2010/07/14 2010/08/02 2010/08/03	QUALITY SYMBOLS	GENERAL TOLERANCES (UNLESS SPECIFIED)	DIMENSION STYLE	SCALE	DESIGN UNITS	THIRD ANGLE PROJECTION																								
	$\nabla=0$ $\nabla=0$ $\nabla=0$	<table border="1"> <tr><th colspan="2">mm</th><th colspan="2">INCH</th></tr> <tr><td>4 PLACES</td><td>±---</td><td>±---</td><td>±---</td></tr> <tr><td>3 PLACES</td><td>±---</td><td>±---</td><td>±---</td></tr> <tr><td>2 PLACES</td><td>±0.2</td><td>±---</td><td>±---</td></tr> <tr><td>1 PLACE</td><td>±---</td><td>±---</td><td>±---</td></tr> <tr><td colspan="4">ANGULAR ± 3°</td></tr> </table>	mm		INCH		4 PLACES	±---	±---	±---	3 PLACES	±---	±---	±---	2 PLACES	±0.2	±---	±---	1 PLACE	±---	±---	±---	ANGULAR ± 3°				MM ONLY	NTS	METRIC	
	mm		INCH																											
	4 PLACES	±---	±---	±---																										
3 PLACES	±---	±---	±---																											
2 PLACES	±0.2	±---	±---																											
1 PLACE	±---	±---	±---																											
ANGULAR ± 3°																														
DRAWN BY: SKLIM01 CHECKED BY: PATEY APPROVED BY: MLONG DATE: 2006/02/09 DATE: 2006/02/16 DATE: 2010/02/08	MATERIAL NO. <b>SEE TABLE</b>	TITLE CUSTOM HEADER 2.54MM PITCH DUAL ROW HEADER SINGLE WAFER SMT <b>MOLEX INCORPORATED</b>	DOCUMENT NO. SD-87920-020	SHEET NO. 3 OF 11																										
REV: D6	DRAFT WHERE APPLICABLE MUST REMAIN WITHIN DIMENSIONS	THIS DRAWING CONTAINS INFORMATION THAT IS PROPRIETARY TO MOLEX INCORPORATED AND SHOULD NOT BE USED WITHOUT WRITTEN PERMISSION																												

9 8 7 6 5 4 3 2 1

10 9 8 7 6 5 4 3 2 1

CKT	F	P1	W
06	11.50	12.00	24.00

THIS TYPE OF CARRIER TAPE IS FOR CKT SIZE 06 ONLY

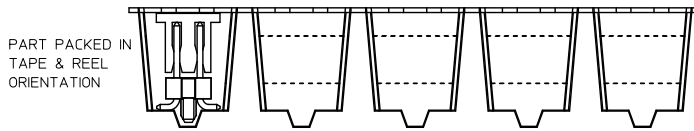
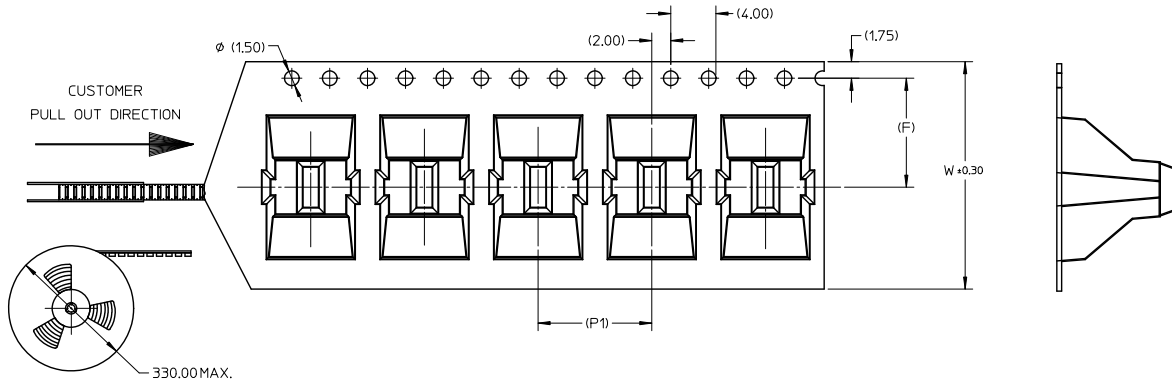

NOTES:

1. LEADER AND TRAILER TAPE

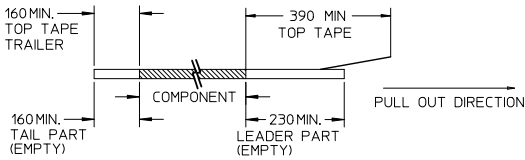

2. PEELING OFF FORCE OF THE TOP TAPE: 20-80gf. (PEELING DIRECTION AS SHOWN IN FOLLOWING FIGURE)

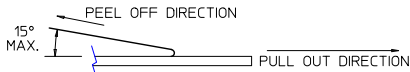

- 3. PACKAGING STANDARD IS AS PER EIA-481.
- 4. TAPE & REEL QUANTITY = 440PCS/REEL
- 5. THE TAPE IS TREATED FOR ANTI-STATIC.

ADD P/N: 87920-9120 EC NO: S2011-0043 DRAWN: KANG CHKD: ATSEE APPR: MLONG REV: D6	QUALITY SYMBOLS √=0 √=0 √=0	GENERAL TOLERANCES (UNLESS SPECIFIED)		DIMENSION STYLE MM ONLY		SCALE NTS	DESIGN UNITS METRIC	THIRD ANGLE PROJECTION
		4 PLACES ± --- ± ---	3 PLACES ± --- ± ---	2 PLACES ± 0.2 ± ---	1 PLACE ± --- ± ---	ANGULAR ± 3 °	DRAWN BY: SKL IM01 DATE: 2006/02/09	CHECKED BY: PATEY DATE: 2006/02/16
DRAFT WHERE APPLICABLE MUST REMAIN WITHIN DIMENSIONS		MATERIAL NO. SEE TABLE		APPROVED BY: MLONG DATE: 2010/02/08		DOCUMENT NO. SD-87920-020		SHEET NO. 4 OF 11
THIS DRAWING CONTAINS INFORMATION THAT IS PROPRIETARY TO MOLEX INCORPORATED AND SHOULD NOT BE USED WITHOUT WRITTEN PERMISSION								

9 8 7 6 5 4 3 2 1

10 9 8 7 6 5 4 3 2 1

CKT	F	P1	W
08	11.50	12.00	24.00
10	11.50	12.00	24.00

THIS TYPE OF CARRIER TAPE IS FOR CKT SIZE 08 AND 10 ONLY

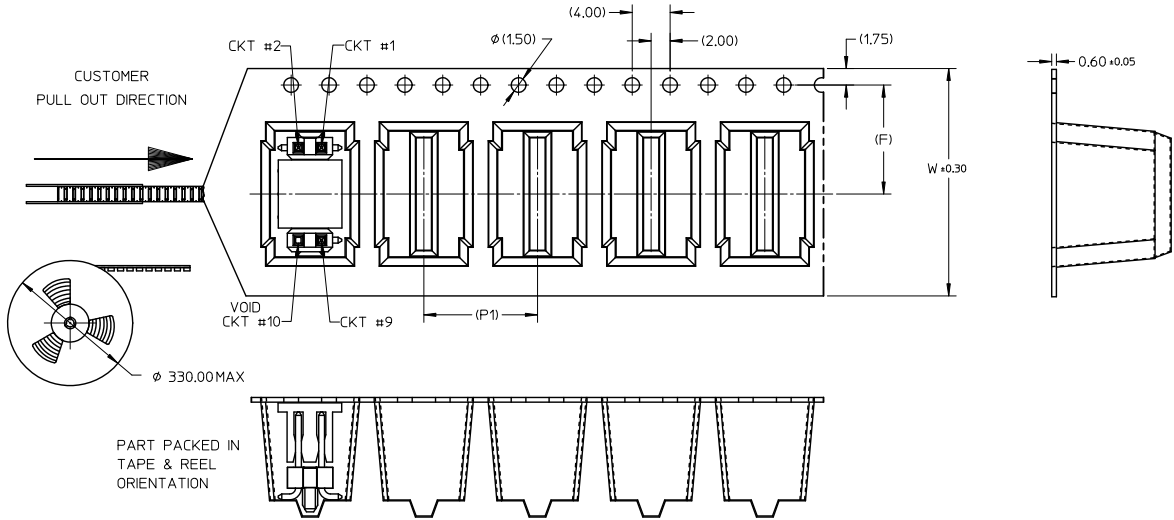

NOTES:

1. LEADER AND TRAILER TAPE

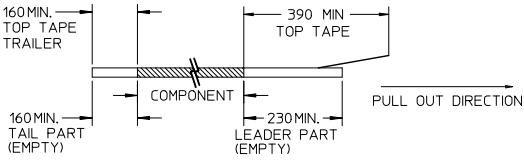

2. PEELING OFF FORCE OF THE TOP TAPE: 20-80gf.  
(PEELING DIRECTION AS SHOWN IN FOLLOWING FIGURE)

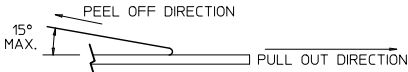

- 3. PACKAGING STANDARD IS AS PER EIA-481.
- 4. TAPE & REEL QUANTITY = 440PCS/REEL.
- 5. THE TAPE IS TREATED FOR ANTI-STATIC.
- 6. ATTACHED ABOVE CONNECTOR IN T&R WITH VOID CKT#10 IS FOR ILLUSTRATION ONLY.

ADD P/N: 87920-9120 EC NO: S2011-0043 DRAWN: KANG CHK: DATSEE APPR: MLONG 2010/07/14 2010/08/02 2010/08/03	QUALITY SYMBOLS	GENERAL TOLERANCES (UNLESS SPECIFIED)	DIMENSION STYLE	SCALE	DESIGN UNITS	THIRD ANGLE PROJECTION																		
	$\nabla=0$ $\nabla=0$ $\nabla=0$	<table border="1"> <thead> <tr> <th></th> <th>mm</th> <th>INCH</th> </tr> </thead> <tbody> <tr> <td>4 PLACES</td> <td>±---</td> <td>±---</td> </tr> <tr> <td>3 PLACES</td> <td>±---</td> <td>±---</td> </tr> <tr> <td>2 PLACES</td> <td>±0.2</td> <td>±---</td> </tr> <tr> <td>1 PLACE</td> <td>±---</td> <td>±---</td> </tr> <tr> <td colspan="3">ANGULAR ± 3°</td> </tr> </tbody> </table>		mm	INCH	4 PLACES	±---	±---	3 PLACES	±---	±---	2 PLACES	±0.2	±---	1 PLACE	±---	±---	ANGULAR ± 3°			MM ONLY DRAWN BY: SKLIM01 CHECKED BY: PATEY APPROVED BY: MLONG DATE: 2006/02/09 DATE: 2006/02/16 DATE: 2010/02/08	NTS	METRIC	CUSTOM HEADER 2.54MM PITCH DUAL ROW HEADER SINGLE WAFER SMT MOLEX INCORPORATED
		mm	INCH																					
	4 PLACES	±---	±---																					
3 PLACES	±---	±---																						
2 PLACES	±0.2	±---																						
1 PLACE	±---	±---																						
ANGULAR ± 3°																								
D6 REV	DRAFT WHERE APPLICABLE MUST REMAIN WITHIN DIMENSIONS	MATERIAL NO. SEE TABLE SIZE: A3	DOCUMENT NO. SD-87920-020	SHEET NO. 5 OF 11	THIS DRAWING CONTAINS INFORMATION THAT IS PROPRIETARY TO MOLEX INCORPORATED AND SHOULD NOT BE USED WITHOUT WRITTEN PERMISSION																			

9 8 7 6 5 4 3 2 1

CKT	F	P1	So	W
12	14.20	12.00	28.40	32.00
14	14.20	12.00	28.40	32.00
16	14.20	12.00	28.40	32.00
20	20.20	12.00	40.40	44.00

THIS TYPE OF CARRIER TAPE IS FOR CKT SIZE 12, 14, 16 AND 20

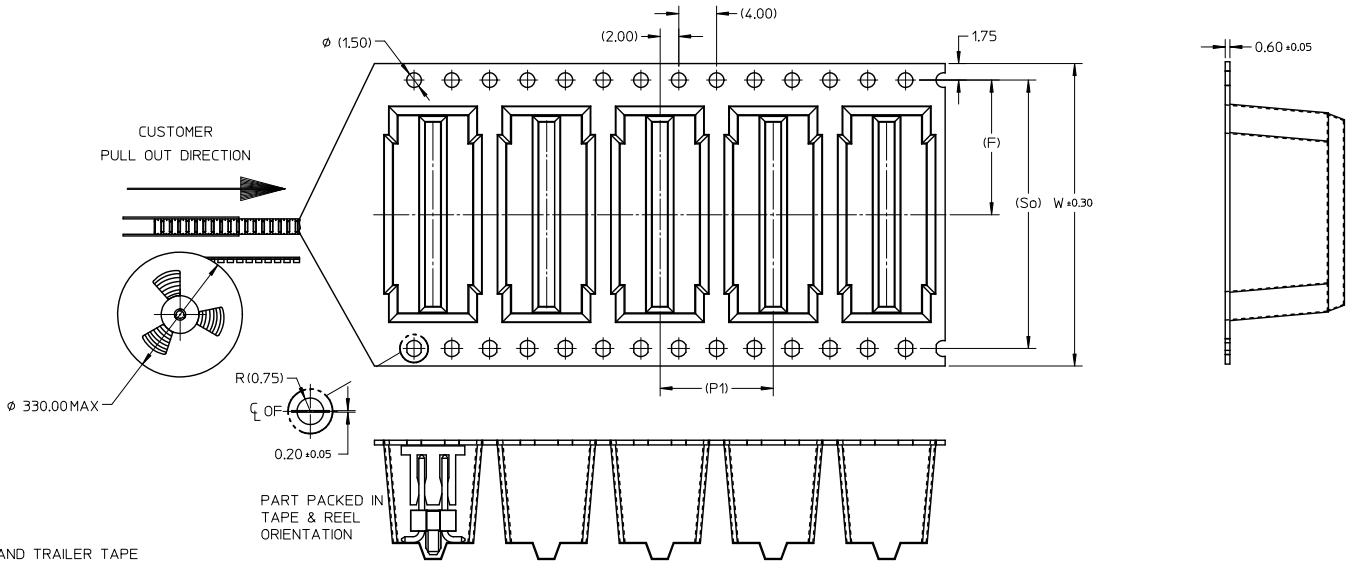

NOTES:

1. LEADER AND TRAILER TAPE

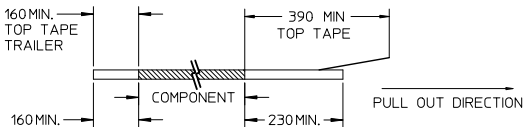

2. PEELING OFF FORCE OF THE TOP TAPE: 20-80gf. (PEELING DIRECTION AS SHOWN IN FOLLOWING FIGURE)

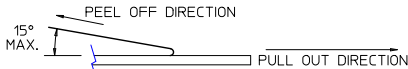

- 3. PACKAGING STANDARD IS AS PER EIA-481.
- 4. TAPE & REEL QUANTITY = 440PCS/REEL.
- 5. THE TAPE IS TREATED FOR ANTI-STATIC.

ADD P/N: 87920-9120 EC NO: S2011-0043 DRW:SKANG CHKD:ATSEE APPR:HLONG	QUALITY SYMBOLS ▽=0 ▽=0 ▽=0	GENERAL TOLERANCES (UNLESS SPECIFIED)		DIMENSION STYLE		SCALE	DESIGN UNITS	THIRD ANGLE PROJECTION
		mm	INCH	MM ONLY	DATE			
D6	DESCRIPTION	4 PLACES	± ---	± ---	DRAWN BY	DATE	CUSTOM HEADER 2.54MM PITCH DUAL ROW HEADER SINGLE WAFER SMT MOLEX INCORPORATED	SHEET NO. 6 OF 11
		3 PLACES	± ---	± ---	SKL I M 01	2006/02/09		
		2 PLACES	± 0.2	± ---	CHECKED BY	DATE		
		1 PLACE	± ---	± ---	PATEY	2006/02/16		
		ANGULAR	± 3 °	± ---	APPROVED BY	DATE		
					MLONG	2010/02/08	DOCUMENT NO.	SD-87920-020
					MATERIAL NO.	SEE TABLE		
					DRAFT WHERE APPLICABLE MUST REMAIN WITHIN DIMENSIONS			
					THIS DRAWING CONTAINS INFORMATION THAT IS PROPRIETARY TO MOLEX INCORPORATED AND SHOULD NOT BE USED WITHOUT WRITTEN PERMISSION			

10 9 8 7 6 5 4 3 2 1

CKT	F	P1	So	W
40	34.20	16.00	68.50	72.00

THIS TYPE OF CARRIER TAPE IS FOR CKT SIZE 40

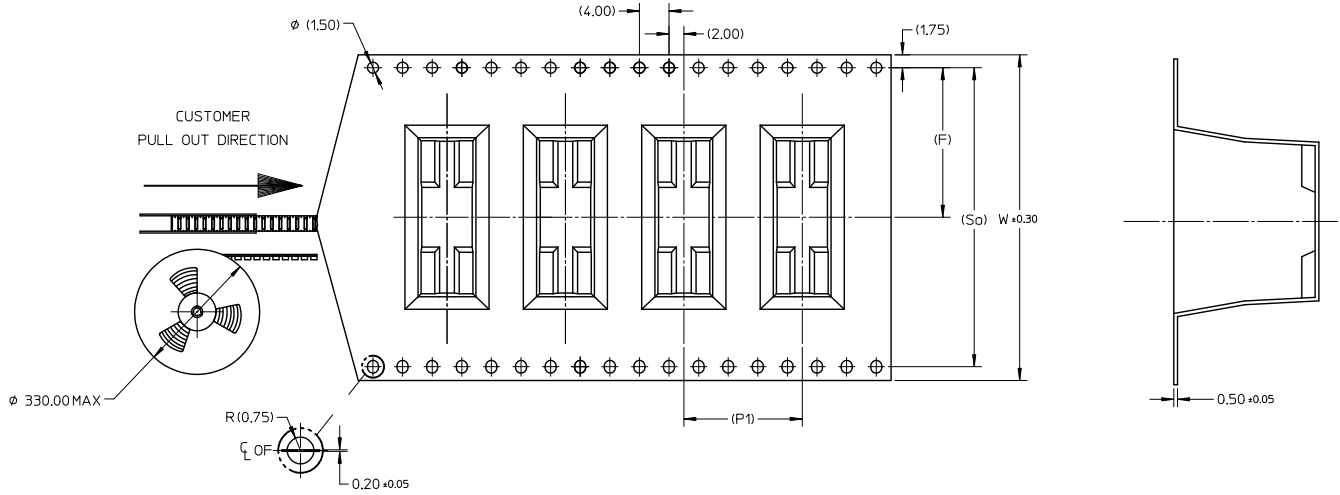

NOTES:

1. LEADER AND TRAILER TAPE

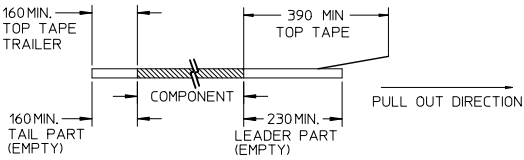

2. PEELING OFF FORCE OF THE TOP TAPE: 20-80gf. (PEELING DIRECTION AS SHOWN IN FOLLOWING FIGURE)

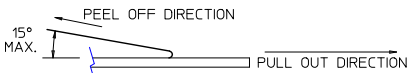

- 3. PACKAGING STANDARD IS AS PER EIA-481.
- 4. TAPE & REEL QUANTITY = 250PCS/REEL.
- 5. THE TAPE IS TREATED FOR ANTI-STATIC.

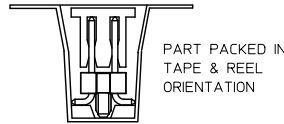

ADD P/N: 87920-9120 EC NO: S2011-0043 DRAWN: KANG CHK: DATSEE APPR: MLONG	QUALITY SYMBOLS √=0 √=0 √=0	GENERAL TOLERANCES (UNLESS SPECIFIED)		DIMENSION STYLE MM ONLY		SCALE NTS	DESIGN UNITS METRIC	THIRD ANGLE PROJECTION	
		4 PLACES ± --- ± ---	3 PLACES ± --- ± ---	2 PLACES ± 0.2 ± ---	1 PLACE ± --- ± ---	ANGULAR ± 3 °	DRAWN BY SKL IM01	DATE 2006/02/09	TITLE CUSTOM HEADER 2.54MM PITCH DUAL ROW HEADER SINGLE WAFER SMT
REV D6	DESCRIPTION	DRAFT WHERE APPLICABLE MUST REMAIN WITHIN DIMENSIONS		MATERIAL NO. SEE TABLE		DOCUMENT NO. SD-87920-020		SHEET NO. 7 OF 11	
		THIS DRAWING CONTAINS INFORMATION THAT IS PROPRIETARY TO MOLEX INCORPORATED AND SHOULD NOT BE USED WITHOUT WRITTEN PERMISSION							

9 8 7 6 5 4 3 2 1





**Distributor of Molex Connector Corporation: Excellent Integrated System Limited**

Datasheet of 0879209120 - 2.54MM DRSW SMT HDR

Contact us: sales@integrated-circuit.com Website: www.integrated-circuit.com

PART NUMBER IN PACKAGING OPTION										CTK SIZE	PEG	PLATE OPT.	VOID CKT	DIMENSION														
TAPE & REEL WITH CAP	TUBE WITHOUT CAP	TUBE WITH CAP	CTK SIZE	PEG	PLATE OPT.	VOID CKT	A	B	C	F	G	M	PART NUMBER IN PACKAGING OPTION															
													TAPE & REEL WITH CAP	TUBE WITHOUT CAP	TUBE WITH CAP	CTK SIZE	PEG	PLATE OPT.	A	B	C	F	G	M				
87920-9111	87920-9044		4	N	1	--	5.08	2.54	----	9.66	10.66	6.10	-----	-----	-----	-----	-----	-----	-----	-----	-----	-----	-----	-----	-----	-----	-----	
87920-9211	87920-9045		4	N	2	--	5.08	2.54	----	9.66	10.66	6.10	-----	-----	-----	-----	-----	-----	-----	-----	-----	-----	-----	-----	-----	-----	-----	
87920-9311	87920-9046		4	N	3	--	5.08	2.54	----	9.66	10.66	6.10	-----	△ 87920-9047	-----	4	Y	3	5.08	2.54	----	9.66	10.66	6.10	-----	-----	-----	
87920-9112	87920-9064		6	N	1	--	7.62	5.08	----	9.66	10.66	6.10	-----	-----	-----	-----	-----	-----	-----	-----	-----	-----	-----	-----	-----	-----	-----	
87920-9212	87920-9065		6	N	2	--	7.62	5.08	----	9.66	10.66	6.10	-----	-----	-----	-----	-----	-----	-----	-----	-----	-----	-----	-----	-----	-----	-----	
87920-9312	87920-9066		6	N	3	--	7.62	5.08	----	9.66	10.66	6.10	-----	-----	-----	-----	-----	-----	-----	-----	-----	-----	-----	-----	-----	-----	-----	
87920-9113	87920-9084	87920-9087	8	N	1	--	10.16	7.62	----	9.66	10.66	6.10	-----	87920-8113	87920-8084	87920-8087	8	Y	1	10.16	7.62	5.08	9.66	10.66	6.10	-----	-----	-----
87920-9213	87920-9085	87920-9088	8	N	2	--	10.16	7.62	----	9.66	10.66	6.10	-----	87920-8213	87920-8085	87920-8088	8	Y	2	10.16	7.62	5.08	9.66	10.66	6.10	-----	-----	-----
87920-9313	87920-9086	87920-9089	8	N	3	--	10.16	7.62	----	9.66	10.66	6.10	-----	87920-8313	87920-8086	87920-8089	8	Y	3	10.16	7.62	5.08	9.66	10.66	6.10	-----	-----	-----
87920-9114	87920-9104	87920-9107	10	N	1	--	12.70	10.16	----	9.66	10.66	6.10	-----	87920-8114	87920-8104	87920-8107	10	Y	1	12.70	10.16	7.62	9.66	10.66	6.10	-----	-----	-----
87920-9214	87920-9105	87920-9108	10	N	2	--	12.70	10.16	----	9.66	10.66	6.10	-----	87920-8214	87920-8105	87920-8108	10	Y	2	12.70	10.16	7.62	9.66	10.66	6.10	-----	-----	-----
87920-9314	87920-9106	87920-9109	10	N	3	--	12.70	10.16	----	9.66	10.66	6.10	-----	87920-8314	87920-8106	87920-8109	10	Y	3	12.70	10.16	7.62	9.66	10.66	6.10	-----	-----	-----
87920-1007	-----	-----	10	N	1	10	12.70	10.16	----	9.66	10.66	6.10	-----	-----	-----	-----	-----	-----	-----	-----	-----	-----	-----	-----	-----	-----	-----	-----

△ PART TO BE PACKED IN BULK/TRAY PACKAGING.

ADD P/N: 87920-9120 EC NO: S2011-0043 DRAWN BY: DRWNSKANG CHKD BY: CHKDATSEE APPR: MLONG	QUALITY SYMBOLS	GENERAL TOLERANCES (UNLESS SPECIFIED)	DIMENSION STYLE	SCALE	DESIGN UNITS	THIRD ANGLE PROJECTION
	$\sqrt{\text{V}}=0$ $\text{V}=0$ $\text{V}=0$	mm INCH	MM ONLY	NTS	METRIC	CUSTOM HEADER 2.54MM PITCH DUAL ROW HEADER SINGLE WAFER SMT
	4 PLACES ± --- ± --- 3 PLACES ± --- ± --- 2 PLACES ± 0.2 ± --- 1 PLACE ± --- ± ---	DRAWN BY: SKLIM01 DATE: 2006/02/09 CHECKED BY: DATE: APPROVED BY: PATEY DATE: 2006/02/16 DATE: 2010/02/08	MATERIAL NO.	DOCUMENT NO.	MOLEX	MOLEX INCORPORATED
	DRAFT WHERE APPLICABLE MUST REMAIN WITHIN DIMENSIONS	SEE TABLE	SD-87920-020	SHEET NO. 8 OF 11	THIS DRAWING CONTAINS INFORMATION THAT IS PROPRIETARY TO MOLEX INCORPORATED AND SHOULD NOT BE USED WITHOUT WRITTEN PERMISSION	
	REV D6	DESCRIPTION	SIZE A3			



PART NUMBER IN PACKAGING OPTION										DIMENSION						PART NUMBER IN PACKAGING OPTION										DIMENSION					
TAPE & REEL W/O CAP	TAPE & REEL WITH CAP	TUBE WITHOUT CAP	TUBE WITH CAP	CKT SIZE	PEG	PLATE OPT.	A	B	C	F	G	M	TAPE & REEL WITH CAP	TUBE WITHOUT CAP	TUBE WITH CAP	CKT SIZE	PEG	PLATE OPT.	A	B	C	F	G	M							
87920-9120	87920-9119	87920-9124	87920-9127	12	N	1	15.24	12.70	-----	9.66	10.66	6.10	-----	87920-8124	87920-8127	12	Y	1	15.24	12.70	10.16	9.66	10.66	6.10							
-----	-----	87920-9125	87920-9128	12	N	2	15.24	12.70	-----	9.66	10.66	6.10	-----	87920-8125	87920-8128	12	Y	2	15.24	12.70	10.16	9.66	10.66	6.10							
-----	-----	87920-9126	87920-9129	12	N	3	15.24	12.70	-----	9.66	10.66	6.10	-----	87920-8126	87920-8129	12	Y	3	15.24	12.70	10.16	9.66	10.66	6.10							
-----	87920-9115	87920-9144	87920-9147	14	N	1	17.78	15.24	-----	9.66	10.66	6.10	87920-8115	87920-8144	87920-8147	14	Y	1	17.78	15.24	12.70	9.66	10.66	6.10							
-----	87920-9215	87920-9145	87920-9148	14	N	2	17.78	15.24	-----	9.66	10.66	6.10	87920-8215	87920-8145	87920-8148	14	Y	2	17.78	15.24	12.70	9.66	10.66	6.10							
-----	87920-9315	87920-9146	87920-0014	14	N	3	17.78	15.24	-----	9.66	10.66	6.10	87920-8315	87920-8146	87920-8149	14	Y	3	17.78	15.24	12.70	9.66	10.66	6.10							
-----	87920-9116	87920-9164	87920-9167	16	N	1	20.32	17.78	-----	9.66	10.66	6.10	87920-8116	87920-8164	87920-8167	16	Y	1	20.32	17.78	15.24	9.66	10.66	6.10							
-----	87920-9216	87920-9165	87920-9168	16	N	2	20.32	17.78	-----	9.66	10.66	6.10	87920-8216	87920-8165	87920-8168	16	Y	2	20.32	17.78	15.24	9.66	10.66	6.10							
-----	87920-9316	87920-9166	87920-9169	16	N	3	20.32	17.78	-----	9.66	10.66	6.10	87920-8316	87920-8166	87920-8169	16	Y	3	20.32	17.78	15.24	9.66	10.66	6.10							
-----	-----	87920-9184	87920-9187	18	N	1	22.86	20.32	-----	9.66	10.66	6.10	-----	87920-8184	87920-8187	18	Y	1	22.86	20.32	17.78	9.66	10.66	6.10							
-----	-----	87920-9185	87920-9188	18	N	2	22.86	20.32	-----	9.66	10.66	6.10	-----	87920-8185	87920-8188	18	Y	2	22.86	20.32	17.78	9.66	10.66	6.10							
-----	-----	87920-9186	87920-9189	18	N	3	22.86	20.32	-----	9.66	10.66	6.10	-----	87920-8186	87920-8189	18	Y	3	22.86	20.32	17.78	9.66	10.66	6.10							
-----	87920-9117	87920-9204	87920-9207	20	N	1	25.40	22.86	-----	9.66	10.66	6.10	87920-8117	87920-8204	87920-8207	20	Y	1	25.40	22.86	20.32	9.66	10.66	6.10							
-----	87920-9217	87920-9205	87920-9208	20	N	2	25.40	22.86	-----	9.66	10.66	6.10	87920-8217	87920-8205	87920-8208	20	Y	2	25.40	22.86	20.32	9.66	10.66	6.10							
-----	87920-9317	87920-9206	87920-9209	20	N	3	25.40	22.86	-----	9.66	10.66	6.10	87920-8317	87920-8206	87920-8209	20	Y	3	25.40	22.86	20.32	9.66	10.66	6.10							

ADD P/N: 87920-9120 EC NO: S2011-0043 DRAWN: KANG CHK: DATSEE APPR: MLONG 2010/07/14 2010/08/02 2010/08/03	QUALITY SYMBOLS	GENERAL TOLERANCES (UNLESS SPECIFIED)	DIMENSION STYLE	SCALE	DESIGN UNITS	THIRD ANGLE PROJECTION															
	$\sqrt{\text{V}}=0$ $\sqrt{\text{E}}=0$ $\sqrt{\text{F}}=0$	<table border="1"> <tr> <th></th> <th>mm</th> <th>INCH</th> </tr> <tr> <td>4 PLACES</td> <td>± ---</td> <td>± ---</td> </tr> <tr> <td>3 PLACES</td> <td>± ---</td> <td>± ---</td> </tr> <tr> <td>2 PLACES</td> <td>± 0.2</td> <td>± ---</td> </tr> <tr> <td>1 PLACE</td> <td>± ---</td> <td>± ---</td> </tr> </table>		mm	INCH	4 PLACES	± ---	± ---	3 PLACES	± ---	± ---	2 PLACES	± 0.2	± ---	1 PLACE	± ---	± ---	MM ONLY	NTS	METRIC	
		mm	INCH																		
	4 PLACES	± ---	± ---																		
3 PLACES	± ---	± ---																			
2 PLACES	± 0.2	± ---																			
1 PLACE	± ---	± ---																			
DRAFT WHERE APPLICABLE MUST REMAIN WITHIN DIMENSIONS	DRAWN BY: SKL IM01 CHECKED BY: PATEY APPROVED BY: MLONG DATE: 2006/02/09 DATE: 2006/02/16 DATE: 2010/02/08	TITLE: CUSTOM HEADER 2.54MM PITCH DUAL ROW HEADER SINGLE WAFER SMT MOLEX INCORPORATED	MATERIAL NO.: SEE TABLE DOCUMENT NO.: SD-87920-020	SHEET NO. 9 OF 11																	
REV D6	DESCRIPTION																				

PART NUMBER IN PACKAGING OPTION		TUBE WITH CAP	TUBE WITHOUT CAP	TUBE WITH CAP	CKT SIZE	PEG	PLATE OPT.	DIMENSION					
TAPE & REEL WITH CAP	A							B	C	F	G	M	
-----	87920-9224	87920-9227	22	N	1	27.94	25.40	-----	9.66	10.66	6.10		
-----	87920-9225	87920-9228	22	N	2	27.94	25.40	-----	9.66	10.66	6.10		
-----	87920-9226	87920-9229	22	N	3	27.94	25.40	-----	9.66	10.66	6.10		
-----	87920-9244	87920-9247	24	N	1	30.48	27.94	-----	9.66	10.66	6.10		
-----	87920-9245	87920-9248	24	N	2	30.48	27.94	-----	9.66	10.66	6.10		
-----	87920-9246	87920-9249	24	N	3	30.48	27.94	-----	9.66	10.66	6.10		
-----	87920-9264	87920-9267	26	N	1	33.02	30.48	-----	9.66	10.66	6.10		
-----	87920-9265	87920-9268	26	N	2	33.02	30.48	-----	9.66	10.66	6.10		
-----	87920-9266	87920-9269	26	N	3	33.02	30.48	-----	9.66	10.66	6.10		
-----	87920-9284	87920-9287	28	N	1	35.56	33.02	-----	9.66	10.66	6.10		
-----	87920-9285	87920-9288	28	N	2	35.56	33.02	-----	9.66	10.66	6.10		
-----	87920-9286	87920-9289	28	N	3	35.56	33.02	-----	9.66	10.66	6.10		
-----	87920-9304	87920-9307	30	N	1	38.10	35.56	-----	9.66	10.66	6.10		
-----	87920-9305	87920-9308	30	N	2	38.10	35.56	-----	9.66	10.66	6.10		
-----	87920-9306	87920-9309	30	N	3	38.10	35.56	-----	9.66	10.66	6.10		

ADD P/N: 87920-9120 EC NO: S2011-0043 DRAWN: SKANG CHK: KATSEE APPR: MLONG 2010/07/14 2010/08/02 2010/08/03	QUALITY SYMBOLS	GENERAL TOLERANCES (UNLESS SPECIFIED)	DIMENSION STYLE	SCALE	DESIGN UNITS	THIRD ANGLE PROJECTION	
	$\sqrt{\text{A}}=0$ $\sqrt{\text{B}}=0$ $\sqrt{\text{C}}=0$	mm INCH 4 PLACES ± --- ± --- 3 PLACES ± --- ± --- 2 PLACES ± 0.2 ± --- 1 PLACE ± --- ± --- ANGULAR ± 3°	MM ONLY	NTS	METRIC	DRAWN BY: SKL I M01 CHECKED BY: PATEY APPROVED BY: MLONG DATE: 2006/02/09 DATE: 2006/02/16 DATE: 2010/02/08	TITLE: CUSTOM HEADER 2.54MM PITCH DUAL ROW HEADER SINGLE WAFER SMT MOLEX INCORPORATED
	REV: D6	DRAFT WHERE APPLICABLE MUST REMAIN WITHIN DIMENSIONS	SEE TABLE	MATERIAL NO.	DOCUMENT NO.	SHEET NO.	
				SD-87920-020	10 OF 11		



PART NUMBER IN PACKAGING OPTION			CKT SIZE	PEG	PLATE OPT.	DIMENSION					
TAPE & REEL WITH CAP	TUBE WITHOUT CAP	TUBE WITH CAP				A	B	C	F	G	M
-----	87920-9324	87920-9327	32	N	1	40.64	38.10	-----	9.66	10.66	6.10
-----	87920-9325	87920-9328	32	N	2	40.64	38.10	-----	9.66	10.66	6.10
-----	87920-9326	87920-9329	32	N	3	40.64	38.10	-----	9.66	10.66	6.10
-----	87920-9344	87920-9347	34	N	1	43.18	40.64	-----	9.66	10.66	6.10
-----	87920-9345	87920-9348	34	N	2	43.18	40.64	-----	9.66	10.66	6.10
-----	87920-9346	87920-9349	34	N	3	43.18	40.64	-----	9.66	10.66	6.10
-----	87920-9364	87920-9367	36	N	1	45.72	43.18	-----	9.66	10.66	6.10
-----	87920-9365	87920-9368	36	N	2	45.72	43.18	-----	9.66	10.66	6.10
-----	87920-9366	87920-9369	36	N	3	45.72	43.18	-----	9.66	10.66	6.10
-----	87920-9384	87920-9387	38	N	1	48.26	45.72	-----	9.66	10.66	6.10
-----	87920-9385	87920-9388	38	N	2	48.26	45.72	-----	9.66	10.66	6.10
-----	87920-9386	87920-9389	38	N	3	48.26	45.72	-----	9.66	10.66	6.10
87920-9118	87920-9404	87920-9407	40	N	1	50.80	48.26	-----	9.66	10.66	6.10
87920-9218	87920-9405	87920-9408	40	N	2	50.80	48.26	-----	9.66	10.66	6.10
87920-9318	87920-9406	87920-9409	40	N	3	50.80	48.26	-----	9.66	10.66	6.10

PART NUMBER IN PACKAGING OPTION			CKT SIZE	PEG	PLATE OPT.	DIMENSION					
TAPE & REEL WITH CAP	TUBE WITHOUT CAP	TUBE WITH CAP				A	B	C	F	G	M
-----	87920-8324	87920-8327	32	Y	1	40.64	38.10	35.56	9.66	10.66	6.10
-----	87920-8325	87920-8328	32	Y	2	40.64	38.10	35.56	9.66	10.66	6.10
-----	87920-8326	87920-8329	32	Y	3	40.64	38.10	35.56	9.66	10.66	6.10
-----	87920-8344	87920-8347	34	Y	1	43.18	40.64	38.10	9.66	10.66	6.10
-----	87920-8345	87920-8348	34	Y	2	43.18	40.64	38.10	9.66	10.66	6.10
-----	87920-8346	87920-8349	34	Y	3	43.18	40.64	38.10	9.66	10.66	6.10
-----	87920-8364	87920-8367	36	Y	1	45.72	43.18	40.64	9.66	10.66	6.10
-----	87920-8365	87920-8368	36	Y	2	45.72	43.18	40.64	9.66	10.66	6.10
-----	87920-8366	87920-8369	36	Y	3	45.72	43.18	40.64	9.66	10.66	6.10
-----	87920-8384	87920-8387	38	Y	1	48.26	45.72	43.18	9.66	10.66	6.10
-----	87920-8385	87920-8388	38	Y	2	48.26	45.72	43.18	9.66	10.66	6.10
-----	87920-8386	87920-8389	38	Y	3	48.26	45.72	43.18	9.66	10.66	6.10
87920-8118	87920-8404	87920-8407	40	Y	1	50.80	48.26	45.72	9.66	10.66	6.10
87920-8218	87920-8405	87920-8408	40	Y	2	50.80	48.26	45.72	9.66	10.66	6.10
87920-8318	87920-8406	87920-8409	40	Y	3	50.80	48.26	45.72	9.66	10.66	6.10

ADD P/N: 87920-9120 EC NO: S2011-0043 DRAWN: KANG CHK: DATSEE APPR: MLONG	QUALITY SYMBOLS	GENERAL TOLERANCES (UNLESS SPECIFIED)	DIMENSION STYLE	SCALE	DESIGN UNITS	THIRD ANGLE PROJECTION															
	$\sqrt{\text{---}}=0$ $\sqrt{\text{---}}=0$ $\sqrt{\text{---}}=0$	<table border="1"> <tr><th colspan="2">mm</th><th>INCH</th></tr> <tr><td>4 PLACES</td><td>± ---</td><td>± ---</td></tr> <tr><td>3 PLACES</td><td>± ---</td><td>± ---</td></tr> <tr><td>2 PLACES</td><td>± 0.2</td><td>± ---</td></tr> <tr><td>1 PLACE</td><td>± ---</td><td>± ---</td></tr> </table>	mm		INCH	4 PLACES	± ---	± ---	3 PLACES	± ---	± ---	2 PLACES	± 0.2	± ---	1 PLACE	± ---	± ---	MM ONLY	NTS	METRIC	
	mm		INCH																		
	4 PLACES	± ---	± ---																		
3 PLACES	± ---	± ---																			
2 PLACES	± 0.2	± ---																			
1 PLACE	± ---	± ---																			
DRAWN BY: SKL I M 0 1 CHECKED BY: PATEY APPROVED BY: MLONG	DATE: 2006/02/09 DATE: 2006/02/16 DATE: 2010/02/08	TITLE: CUSTOM HEADER 2.54MM PITCH DUAL ROW HEADER SINGLE WAFER SMT		MOLEX INCORPORATED	MATERIAL NO. SEE TABLE DOCUMENT NO. SD-87920-020	SHEET NO. 11 OF 11															
D6 REV	DRAFT WHERE APPLICABLE MUST REMAIN WITHIN DIMENSIONS	SIZE:	THIS DRAWING CONTAINS INFORMATION THAT IS PROPRIETARY TO MOLEX INCORPORATED AND SHOULD NOT BE USED WITHOUT WRITTEN PERMISSION																		