

Excellent Integrated System Limited

Stocking Distributor

Click to view price, real time Inventory, Delivery & Lifecycle Information:

[Comchip Technology](#)

[CDBF42-HF](#)

For any questions, you can email us directly:

sales@integrated-circuit.com

SMD Schottky Barrier Diode



CDBF42/43-HF

$I_o = 200 \text{ mA}$
 $V_R = 30 \text{ Volts}$
 RoHS Device
 Halogen Free

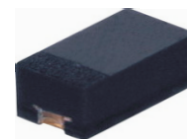

Features

- Low forward voltage.
- Designed for mounting on small surface.
- Extremely thin / leadless package.
- Majority carrier conduction.

Mechanical data

- Case: 1005/SOD-323F standard package, molded plastic.
- Terminals: Gold plated, solderable per MIL-STD-750, method 2026.
- Marking code:
 CDBF42-HF : BD
 CDBF43-HF : BE
- Mounting position: Any
- Weight: 0.006 gram(approx.).

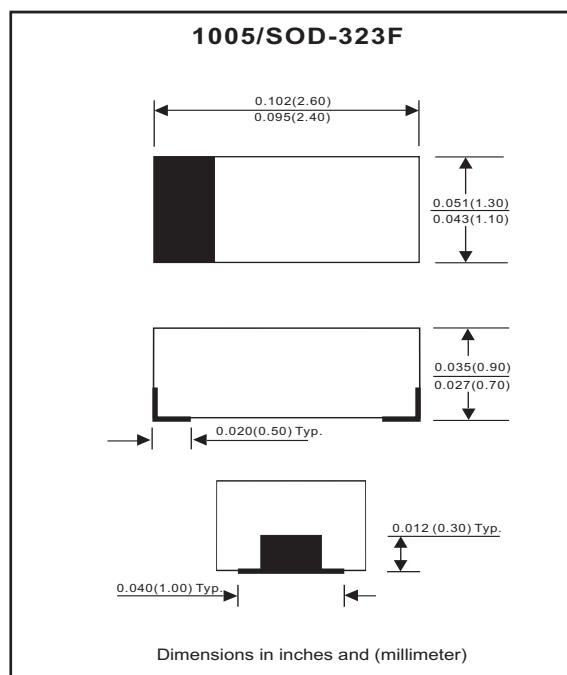

Maximum Rating (at $T_A=25^\circ\text{C}$ unless otherwise noted)

Parameter	Conditions	Symbol	Min	Typ	Max	Unit
Peak reverse voltage		V_{RM}			30	V
Reverse voltage		V_R			30	V
RMS reverse voltage		$V_{R(RMS)}$			21	V
Average forward rectified current		I_o			200	mA
Repetitive peak forward current		I_{FRM}			0.5	A
Forward current,surge peak	8.3 ms single half sine-wave superimposed on rate load(JEDEC method)	I_{FSM}			4	A
Power Dissipation		P_D			200	mW
Thermal resistance junction to ambient air		$R_{\theta JA}$			500	$^\circ\text{C}/\text{W}$
Storage temperature		T_{STG}	-55		+125	$^\circ\text{C}$
Junction temperature		T_j			+125	$^\circ\text{C}$

Electrical Characteristics (at $T_A=25^\circ\text{C}$ unless otherwise noted)

Parameter	Conditions	Symbol	Min	Typ	Max	Unit
Forward voltage	CDBF42/43-HF $I_F = 200\text{mA}$ CDBF42-HF $I_F = 10\text{mA}$ CDBF42-HF $I_F = 50\text{mA}$ CDBF43-HF $I_F = 2\text{mA}$ CDBF43-HF $I_F = 15\text{mA}$	V_F			1 0.4 0.65 0.33 0.45	V
Reverse current	$V_R = 25\text{V}$	I_R			0.5	μA
Capacitance between terminals	$f = 1 \text{ MHz}$, and 1 VDC reverse voltage	C_T			10	pF
Reverse recovery time	$I_F=I_R=10\text{mA}$, $I_{rr}=0.1 \times I_R$, $R_L=100 \text{ ohm}$	T_{rr}			5	nS

SMD Schottky Barrier Diode



RATING AND CHARACTERISTIC CURVES (CDBF42/43-HF)

Fig. 1 - Forward characteristics

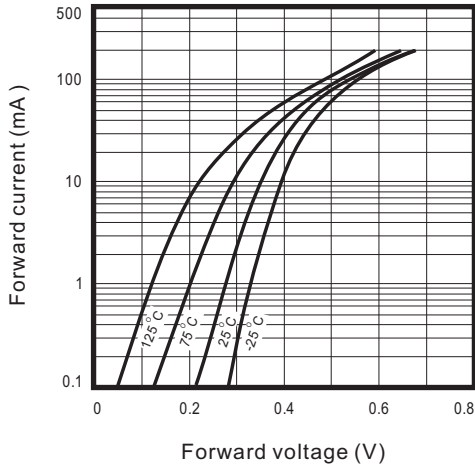

Fig. 2 - Reverse characteristics

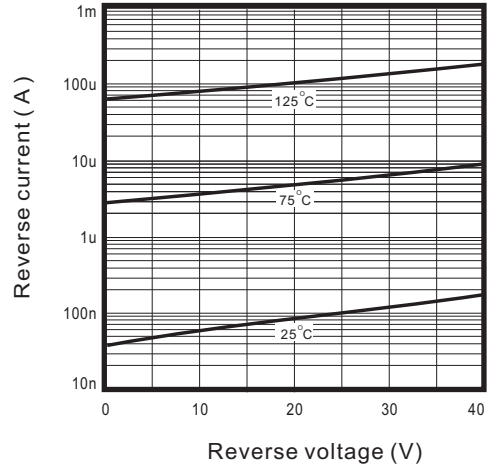

Fig.3 - Capacitance between terminals characteristics

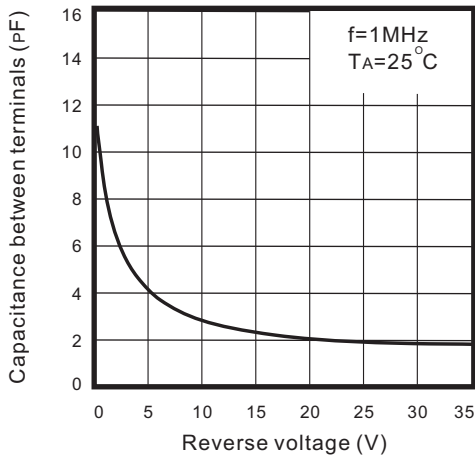
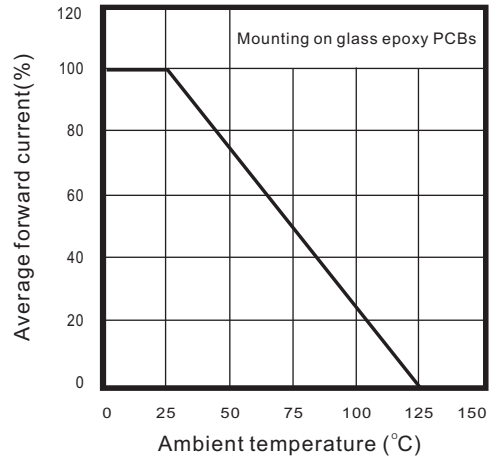

Fig.4 - Current derating curve



SMD Schottky Barrier Diode



Reel Taping Specification

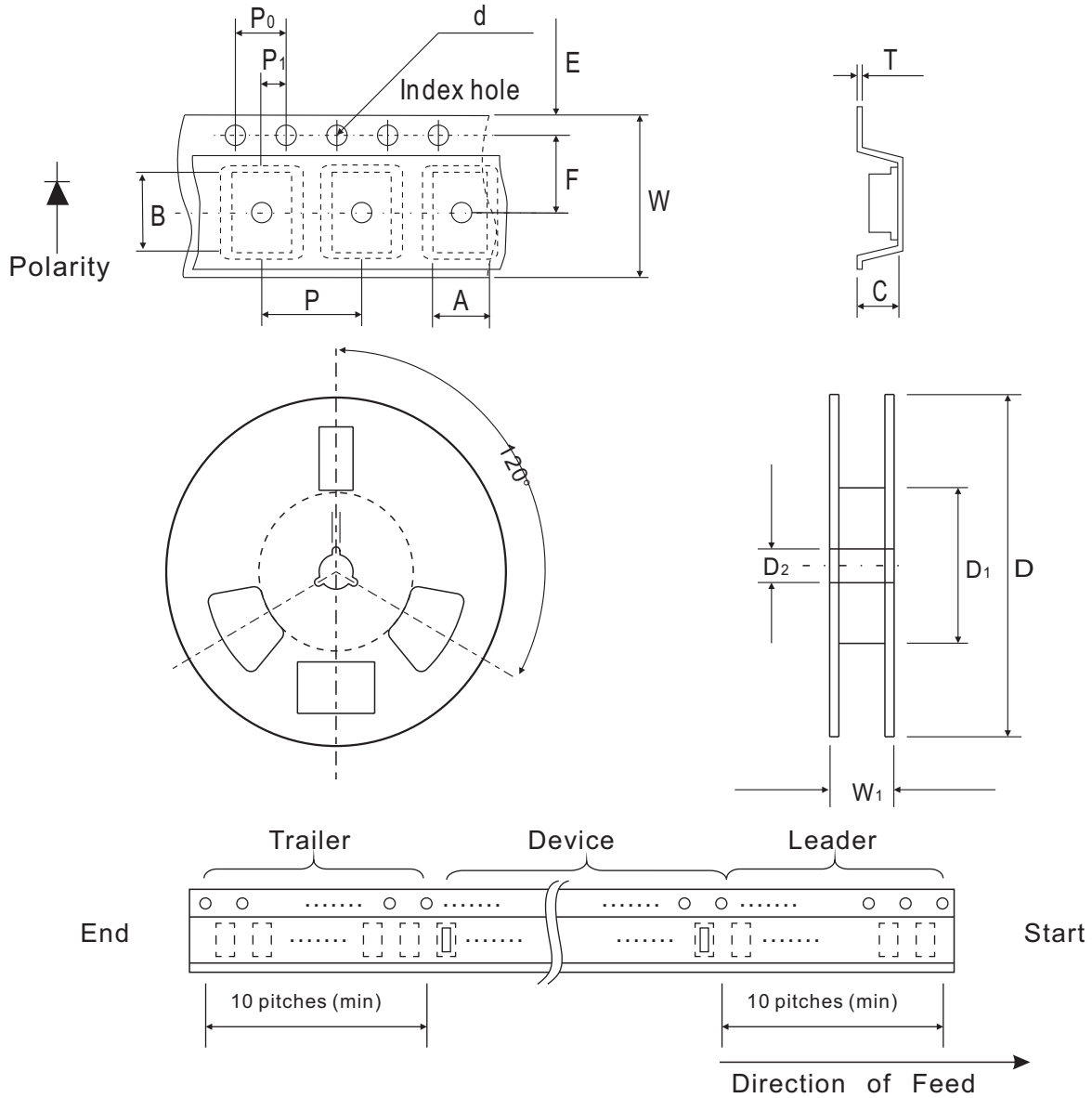

1005 (SOD-323F)	SYMBOL	A	B	C	d	D	D ₁	D ₂
	(mm)	1.55 ± 0.10	2.65 ± 0.10	1.05 ± 0.10	1.55 ± 0.05	178 ± 1	60.0 MIN.	13.0 ± 0.20
	(inch)	0.061 ± 0.004	0.104 ± 0.004	0.041 ± 0.004	0.061 ± 0.002	7.008 ± 0.04	2.362 MIN.	0.512 ± 0.008

1005 (SOD-323F)	SYMBOL	E	F	P	P ₀	P ₁	T	W	W ₁
	(mm)	1.75 ± 0.10	3.50 ± 0.05	4.00 ± 0.10	4.00 ± 0.10	2.00 ± 0.05	0.23 ± 0.05	8.00 ± 0.20	13.5 MAX.
	(inch)	0.069 ± 0.004	0.138 ± 0.002	0.157 ± 0.004	0.157 ± 0.004	0.079 ± 0.004	0.009 ± 0.002	0.315 ± 0.008	0.531 MAX.

SMD Schottky Barrier Diode



Marking Code

Park Number	Marking Code
CDBF42-HF	BD
CDBF43-HF	BE



xx = Product type marking code

Suggested PAD Layout

SIZE	1005/SOD-323F	
	(mm)	(inch)
A	2.10	0.083
B	1.20	0.047
C	1.20	0.047
D	3.30	0.130
E	0.90	0.035

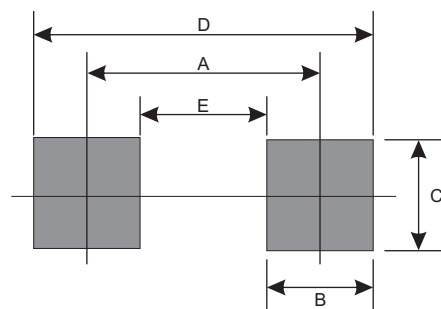

Standard Package

Case Type	Qty per Reel	Reel Size
	(Pcs)	(inch)
1005/SOD-323F	4000	7