

## **Excellent Integrated System Limited**

Stocking Distributor

Click to view price, real time Inventory, Delivery & Lifecycle Information:

[Comchip Technology](#)

[CPDTR0324V-HF](#)

For any questions, you can email us directly:

[sales@integrated-circuit.com](mailto:sales@integrated-circuit.com)

## SMD ESD Protection Diode



# CPDTR0324V-HF

RoHS Device  
 Halogen Free

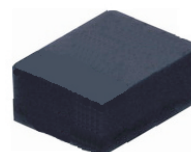

### Features

- Bi-directional ESD protection.
- Surface mount package.
- High component density.

### Mechanical data

- Case: SOT-23F-3P standard package, molded plastic.
- Terminals: Gold plated, solderable per MIL-STD-750, method 2026.
- Marking Code: E24
- Mounting position: Any.
- Weight: 0.012 gram (approx.).

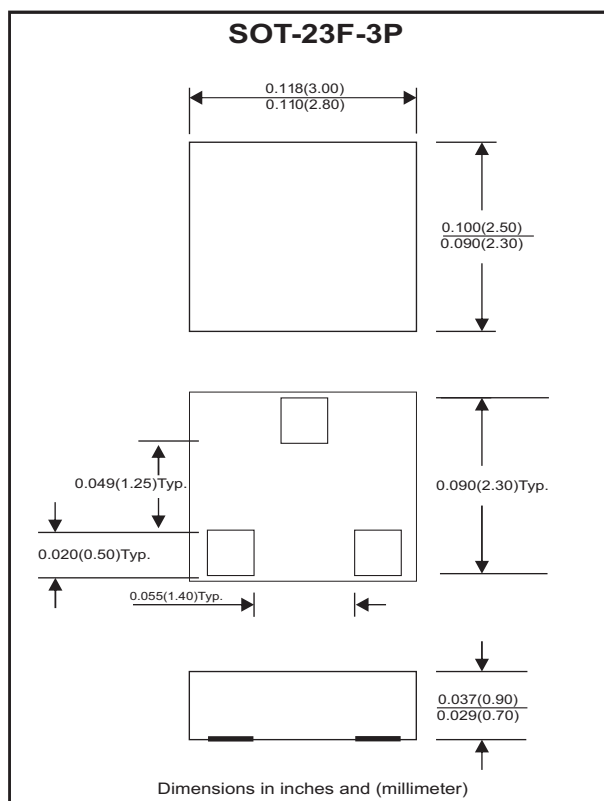
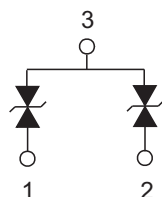

### Electrical Characteristics (at TA=25°C unless otherwise noted)

Parameter	Conditions	Symbol	Min	Typ	Max	Unit
Diode breakdown voltage	IR = 1mA	V <sub>BD</sub>	25	28		V
Leakage current	VR = 24V	I <sub>L</sub>		0.1	2.0	uA
Junction capacitance	VR = 0V, f = 1MHz	C <sub>T</sub>		10		pF
ESD capability	IEC 61000-4-2(air) IEC 61000-4-2(contact)	ESD			16 8	kV
Clamping voltage	I <sub>PP</sub> = 1A, T <sub>P</sub> = 8/20us	V <sub>C</sub>			47	V
Peak pulse power	T <sub>P</sub> = 8/20us	P <sub>PP</sub>			47	W
Operation temperature		T <sub>J</sub>			125	°C
Storage temperature		T <sub>STG</sub>	-55		150	°C

# SMD ESD Protection Diode



## RATING AND CHARACTERISTIC CURVES (CPDTR0324V-HF)

Fig. 1 - 8/20us Peak pulse current wave form acc. IEC 61000-4-5

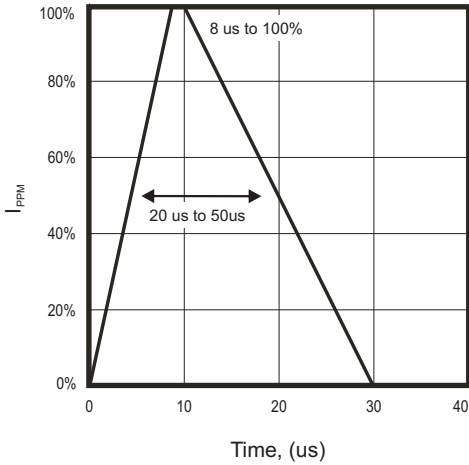

Fig. 2 - Reverse characteristics

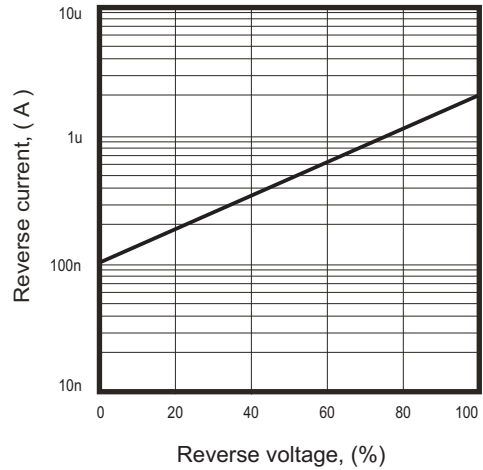

Fig. 3 - Capacitance between terminals characteristics

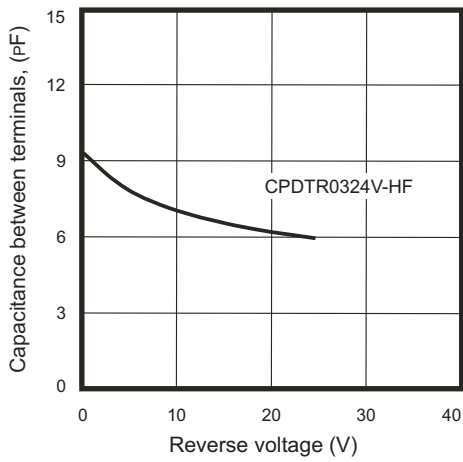
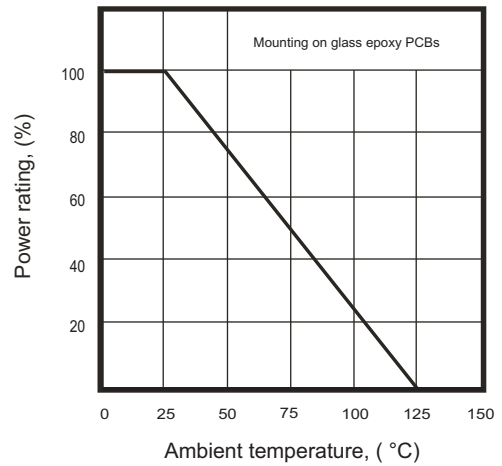

Fig. 4 - Power rating derating curve



# SMD ESD Protection Diode



## Reel Taping Specification

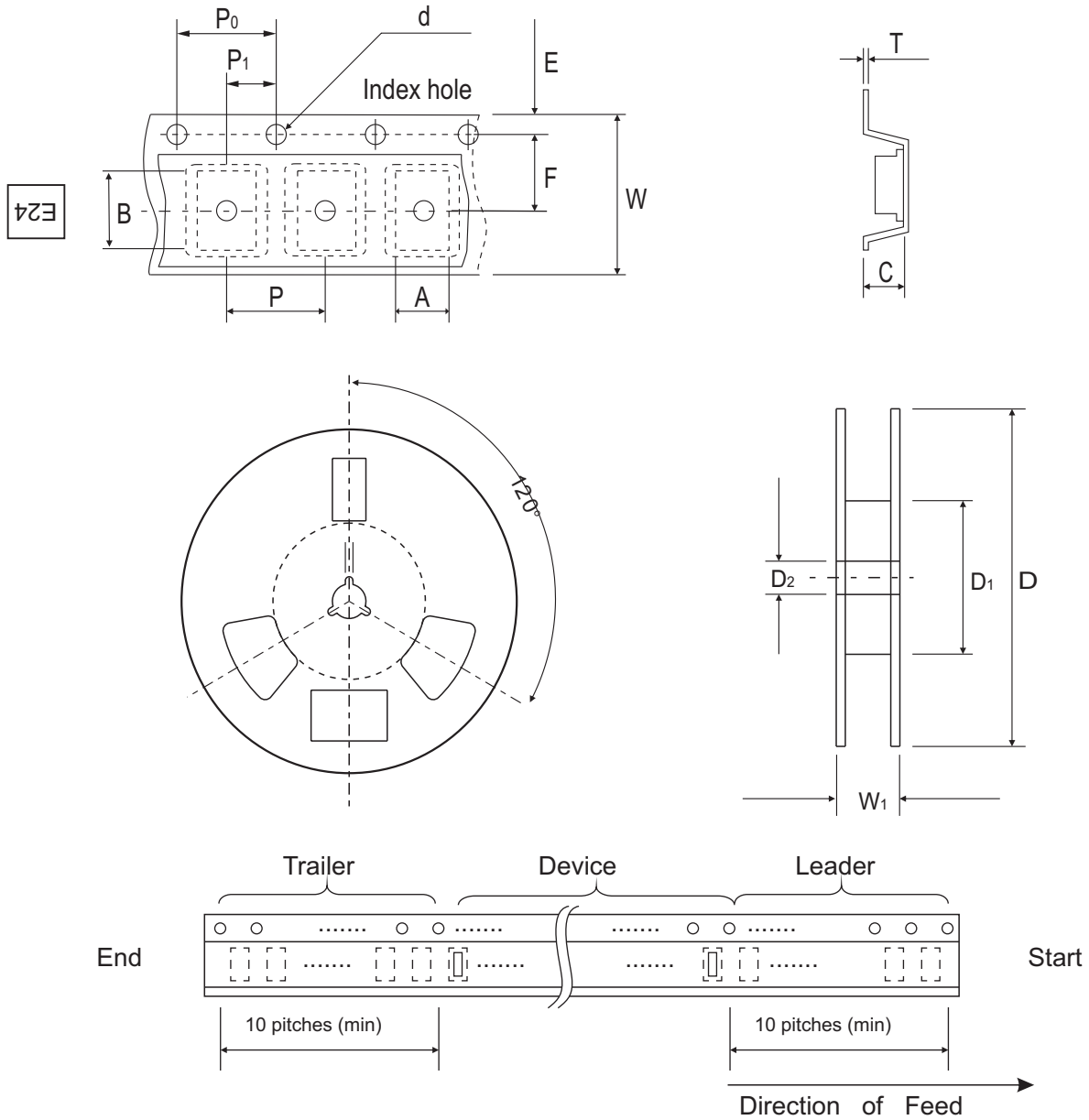

SOT-23F-3P	SYMBOL	A	B	C	d	D	D <sub>1</sub>	D <sub>2</sub>
	(mm)	3.15 ± 0.10	2.65 ± 0.10	0.95 ± 0.10	1.55 ± 0.10	178 ± 1	60.0 MIN.	13.0 ± 0.20
	(inch)	0.124 ± 0.004	0.104 ± 0.004	0.037 ± 0.004	0.061 ± 0.004	7.008 ± 0.04	2.362 MIN.	0.512 ± 0.008

SOT-23F-3P	SYMBOL	E	F	P	P <sub>0</sub>	P <sub>1</sub>	T	W	W <sub>1</sub>
	(mm)	1.75 ± 0.10	3.50 ± 0.05	4.00 ± 0.10	4.00 ± 0.10	2.00 ± 0.10	0.22 ± 0.05	8.00 ± 0.20	13.5 MAX.
	(inch)	0.069 ± 0.004	0.138 ± 0.002	0.157 ± 0.004	0.157 ± 0.004	0.079 ± 0.004	0.009 ± 0.002	0.315 ± 0.008	0.531 MAX.

# SMD ESD Protection Diode

## Marking Code

Part Number	Marking Code
CPDTR0324V-HF	E24



## Suggested PAD Layout

SIZE	SOT-23F-3P	
	(mm)	(inch)
A	1.90	0.075
B	1.10	0.043
C	0.90	0.035
D	1.70	0.067
E	0.80	0.031
F	0.80	0.031

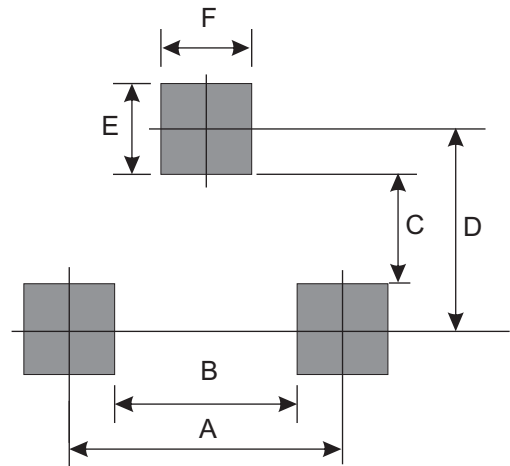

## Standard Packaging

Case Type	Qty Per Reel	Reel Size
	(Pcs)	(inch)
SOT-23F-3P	3,000	7