

Excellent Integrated System Limited

Stocking Distributor

Click to view price, real time Inventory, Delivery & Lifecycle Information:

[Molex Connector Corporation](#)
[0430450629](#)

For any questions, you can email us directly:

sales@integrated-circuit.com

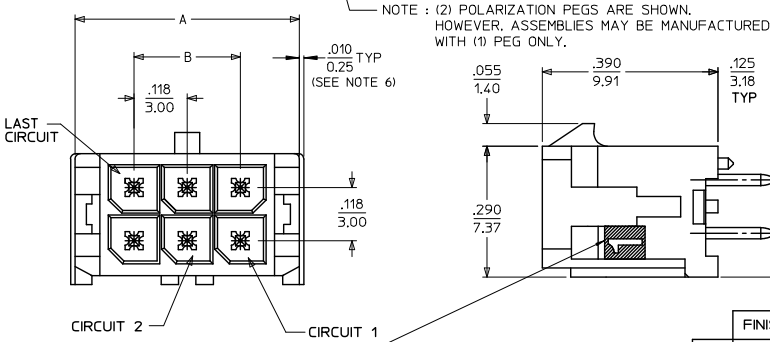
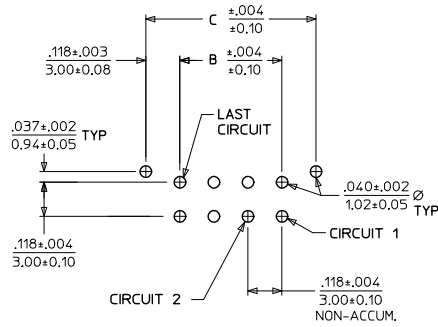
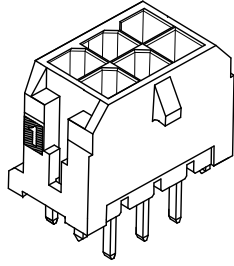
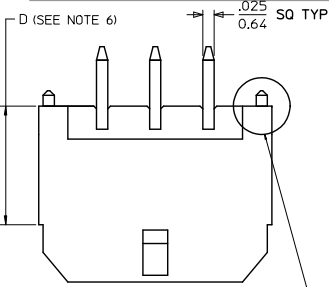

NOTE : (2) POLARIZATION PEGS ARE SHOWN, HOWEVER, ASSEMBLIES MAY BE MANUFACTURED WITH (1) PEG ONLY.

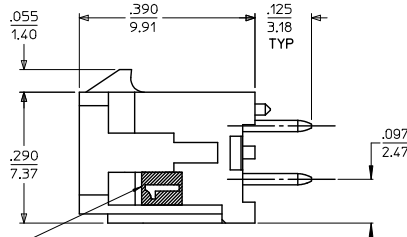

PCB LAYOUT: COMPONENT SIDE
RECOMMEND PCB THICKNESS: .062/157

CKTS	A	B	C
02	.262 6.65	NA	.236 6.00
04	.380 9.65	.118 3.00	.354 9.00
06	.498 12.65	.236 6.00	.472 12.00
08	.616 15.65	.354 9.00	.591 15.00
10	.734 18.65	.472 12.00	.709 18.00
12	.852 21.65	.591 15.00	.827 21.00
14	.970 24.65	.709 18.00	.945 24.00
16	1.088 27.65	.827 21.00	1.063 27.00
18	1.206 30.65	.945 24.00	1.181 30.00
20	1.325 33.65	1.063 27.00	1.299 33.00
22	1.443 36.65	1.181 30.00	1.417 36.00
24	1.561 39.65	1.299 33.00	1.535 39.00

NOTES:

- HOUSING MATERIAL: GLASS FILLED LIQUID CRYSTAL POLYMER, UL94V-0, COLOR-BLACK
TERMINAL MATERIAL: BRASS ALLOY
- FINISH: A = .000060/(0.00152) MIN. REFLOWED MATTE TIN OVER .000050/(0.00127) MIN. NICKEL PLATE. (FINISH IS BRIGHT IN APPEARANCE, THICKNESS AS APPLIED PRIOR TO REFLOW)
B = .000015/(0.00038) MIN. SELECT GOLD IN CONTACT AREA, .000100/(0.00254) MIN. SELECT MATTE TIN ON SOLDER TAILS, BOTH OVER .000050/(0.00127) MIN. NICKEL PLATE.
C = .000030/(0.00076) MIN. SELECT GOLD IN CONTACT AREA, .000100/(0.00254) MIN. SELECT MATTE TIN ON SOLDER TAILS, BOTH OVER .000050/(0.00127) MIN. NICKEL PLATE.
D = .000100/(0.00254) MIN. MATTE TIN OVER .000050/(0.00127) MIN. NICKEL PLATE.
- PRODUCT SPECIFICATION: PS-43045
- TRAY PACKAGED: SEE MOLEX DRAWING PK-70873-0314
- MATES WITH MICRO FIT (3.0) RECEPTACLE SERIES 43025
- CIRCUIT SIZES 2-6: "D" IS .265/6.74 FOR .010/0.25 STEP
CIRCUIT SIZES 8-24: "D" IS .063/1.60 FOR .010/0.25 STEP.
- THIS PART CONFORMS TO CLASS B REQUIREMENTS OF COSMETIC SPECIFICATION PS-45499-002.

CIRCUIT "1" IDENTIFIED ON THIS SURFACE
(APPROX. LOCATION SHOWN FOR REF.)

	FINISH A	FINISH B	FINISH C	FINISH D
CKTS	MATERIAL NO:	MATERIAL NO:	MATERIAL NO:	MATERIAL NO:
02	43045-0227	43045-0228	43045-0229	43045-0298
04	43045-0427	43045-0428	43045-0429	43045-0498
06	43045-0627	43045-0628	43045-0629	43045-0698
08	43045-0827	43045-0828	43045-0829	43045-0898
10	43045-1027	43045-1028	43045-1029	43045-1098
12	43045-1227	43045-1228	43045-1229	43045-1298
14	43045-1427	43045-1428	43045-1429	43045-1498
16	43045-1627	43045-1628	43045-1629	43045-1698
18	43045-1827	43045-1828	43045-1829	43045-1898
20	43045-2027	43045-2028	43045-2029	43045-2098
22	43045-2227	43045-2228	43045-2229	43045-2298
24	43045-2427	43045-2428	43045-2429	43045-2498

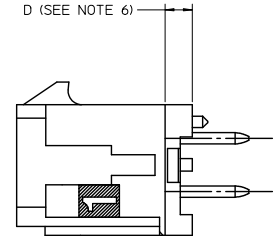

REVISE FINISH A EC NO: UCP2016-0464 2015/08/20 DRAWN: JPOX CHKD: SMOSEK APPROV: SMITH 2015/11/19	QUALITY SYMBOLS ▽=0 ▽=0 ▽=0	GENERAL TOLERANCES (UNLESS SPECIFIED) mm INCH	DIMENSION STYLE IN/MM	SCALE	DESIGN UNITS	THIRD ANGLE PROJECTION
				---	METRIC	☉
				MICRO FIT (3.0) DUAL ROW VERTICAL THRU HOLE HEADER ASS'Y		
				molex		
ANGULAR ±1/2°		MATERIAL NO.	DOCUMENT NO.	SHEET NO.		
DRAFT WHERE APPLICABLE MUST REMAIN WITHIN DIMENSIONS		SEE CHART	SD-43045-010	1 OF 1		
THIS DRAWING CONTAINS INFORMATION THAT IS PROPRIETARY TO MOLEX INCORPORATED AND SHOULD NOT BE USED WITHOUT WRITTEN PERMISSION						