

Excellent Integrated System Limited

Stocking Distributor

Click to view price, real time Inventory, Delivery & Lifecycle Information:

[Molex Connector Corporation](#)

[0461144121](#)

For any questions, you can email us directly:

sales@integrated-circuit.com

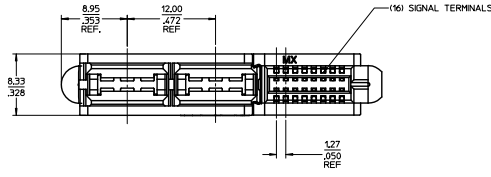

NO OF SIGNALS	MATERIAL NUMBER	COMPLIANT PLATING	DM A	DM B	DM C
12	46114-4120	TN	41.01/1.615	41.51/1.634	
16	46114-4160	TN	43.55/1.715	44.05/1.734	
20	46114-4200	TN	46.09/1.815	46.59/1.834	
24	46114-4240	TN	48.63/1.915	49.13/1.934	5.45/215
28	46114-4280	TN	51.17/2.015	51.67/2.004	
32	46114-4320	TN	53.71/2.115	54.21/2.134	
36	46114-4360	TN	56.25/2.215	56.75/2.234	
40	46114-4400	TN	58.79/2.315	59.29/2.334	

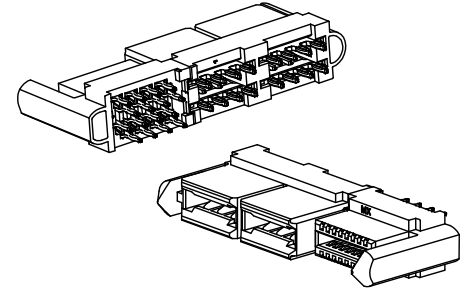
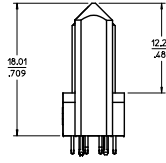
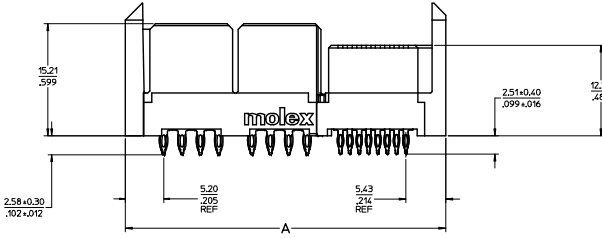

MATERIAL # 46114-4160 SHOWN

- NOTES:
- MATERIAL: HOUSING: LCP, 94-V0, COLOR: BLACK, POWER CONTACTS: COPPER ALLOY, SIGNAL CONTACTS: MOUNTED TN BRASS.
 - FINISH: SELECT GOLD - 0.75 μ M/30 μ INCHES, SELECTED TN - 2.50 μ M/100 μ INCHES, BOTH OVER NICKEL - 1.25 μ M/50 μ INCHES
 - POWER TERMINALS ARE LUBRICATED IN CONTACT AREA.
 - PARTS ARE RHM COMPLIANT.
 - MATES TO MOLEX P/N 45995-SERIES OR CARD EDGE 1571062.
 - PRODUCT SPECIFICATION PS-46114-001.
 - PACKAGING PER PK-46114-003.

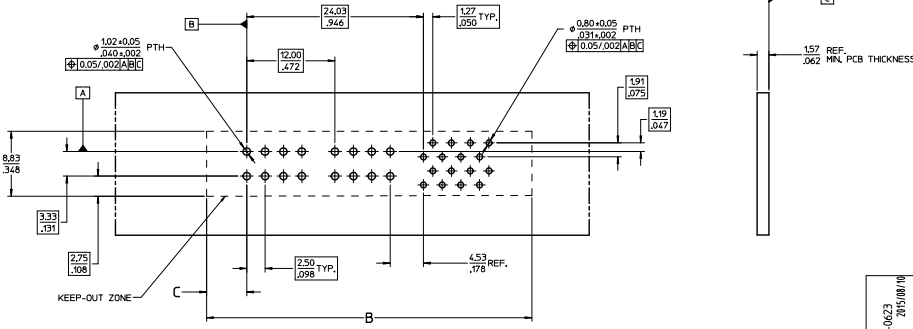

PCB COMPONENT SIDE

SCALE 4:1

QUALITY SYMBOLS	GENERAL TOLERANCES (UNLESS SPECIFIED)	DIMENSION STYLE		SCALE	DESIGN UNITS	THIRD ANGLE PROJECTION
		MM	INCH			
▽=0	4 PLACES ±---	mm	INCH	4:1	METRIC	THIRD ANGLE PROJECTION
▽=0	3 PLACES ±---	mm	INCH	4:1	METRIC	THIRD ANGLE PROJECTION
▽=0	2 PLACES ±0.25 ±---	mm	INCH	4:1	METRIC	THIRD ANGLE PROJECTION
▽=0	1 PLACE ±---	mm	INCH	4:1	METRIC	THIRD ANGLE PROJECTION
▽=0	0 PLACE ±---	mm	INCH	4:1	METRIC	THIRD ANGLE PROJECTION

ADD VIEWS	QUALITY SYMBOLS	GENERAL TOLERANCES (UNLESS SPECIFIED)	DIMENSION STYLE	SCALE	DESIGN UNITS	THIRD ANGLE PROJECTION
EC NO. UEP204-0023	▽=0	4 PLACES ±---	MM/IN	4:1	METRIC	THIRD ANGLE PROJECTION
DRW: BHANDURA 2015/08/10	▽=0	3 PLACES ±---	MM/IN	4:1	METRIC	THIRD ANGLE PROJECTION
CHKD: SUDHAKAR 2015/08/12	▽=0	2 PLACES ±0.25 ±---	MM/IN	4:1	METRIC	THIRD ANGLE PROJECTION
APP: JCOMERC	▽=0	1 PLACE ±---	MM/IN	4:1	METRIC	THIRD ANGLE PROJECTION
REV	▽=0	0 PLACE ±---	MM/IN	4:1	METRIC	THIRD ANGLE PROJECTION

DRAWN BY	DATE	TITLE	DOCUMENT NO.	SHEET NO.
M. KARADI MAS	07/18/07	LPH VERTICAL RECEPTACLE ASSEMBLY 4 CIRCUIT PWR CONNECTOR, PRESS FIT	SD-46114-400	1 OF 3
CHECKED BY	DATE			
A. PATEL	07/20/07			
APPROVED BY	DATE			
J. COMERC	2009/12/03			

NO OF SIGNALS	MATERIAL NUMBER	COMPLIANT PIN PLATING	DM A	DM B	DM C
12	46114-4121	TIN	35.34/1.391	35.84/1.411	
16	46114-4161	TIN	37.88/1.491	38.38/1.511	
20	46114-4201	TIN	40.42/1.591	40.92/1.611	
24	46114-4241	TIN	42.96/1.691	43.46/1.711	2.69/1.06
28	46114-4281	TIN	45.50/1.791	46.00/1.811	
32	46114-4321	TIN	48.04/1.891	48.54/1.911	
36	46114-4361	TIN	50.58/1.991	51.08/2.011	
40	46114-4401	TIN	53.12/2.091	53.62/2.111	

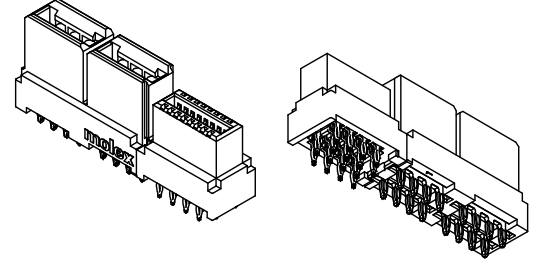
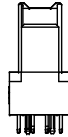
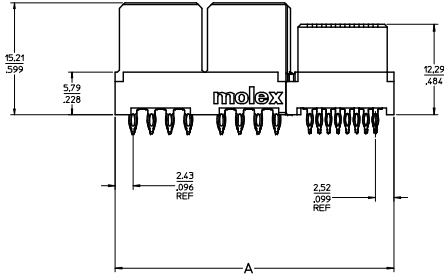
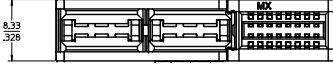

MATERIAL # 46114-4161 SHOWN

SEE SHEET 1 DEC. NO. 067206-0023 DRAWN BY: ANDRASA 2015/08/10 CHKD: JICOMERC APPROVED: JICOMERC 2009/12/03 REV:	QUALITY SYMBOLS	GENERAL TOLERANCES (UNLESS SPECIFIED)	DIMENSION STYLE	SCALE	DESIGN UNITS	THIRD ANGLE PROJECTION
	∇=0 ∇=0 ∇=0	mm INCH 4 PLACES ±--- ±--- 3 PLACES ±--- ±.010 2 PLACES ±0.25 ±--- 1 PLACE ±--- ±--- 0 PLACE ±--- ±---	MM/IN	4:1	METRIC	DRAWN BY: MKARADIMAS 07/18/07 CHECKED BY: DATE APPROVED BY: APATEL 07/20/07 DATE JICOMERC 2009/12/03
		ANGULAR ±1/2°				MATERIAL NO. SEE CHART DOCUMENT NO. SD-46114-400 SHEET NO. 2 OF 3
		DRAFT WHERE APPLICABLE MUST REMAIN WITHIN DIMENSIONS				THIS DRAWING CONTAINS INFORMATION THAT IS PROPRIETARY TO MOLEX INCORPORATED AND SHOULD NOT BE USED WITHOUT WRITTEN PERMISSION

NO OF SIGNAL	DIM D
12	8.00/315
16	10.54/415
20	13.08/515
24	15.62/615
28	18.16/715
32	20.70/815
36	23.24/915
40	25.78/1015

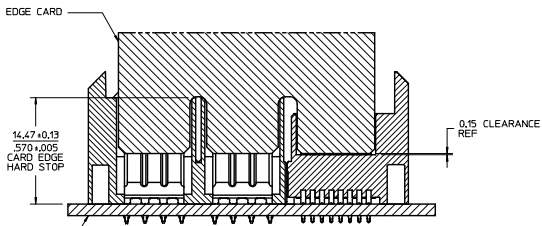

CARD EDGE MATING

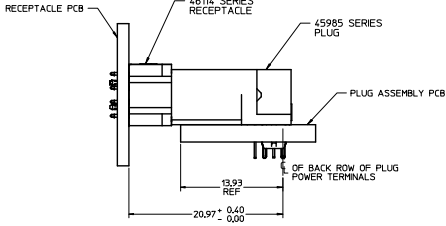

PLUG ASSEMBLY MATING

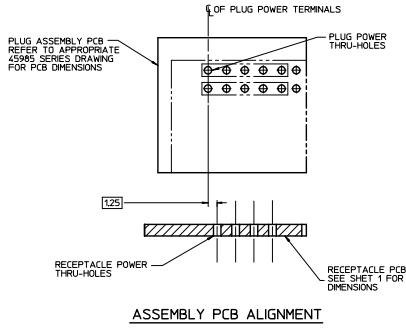

ASSEMBLY PCB ALIGNMENT

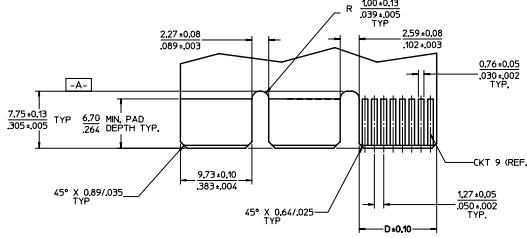
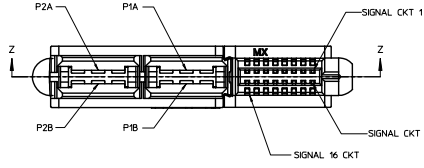

RECOMMENDED EDGE CARD LAYOUT
EDGE CARD THICKNESS: 157/062 + 0.15/006
PLATING: GOLD 30 μ INCHES MIN.
OVER 150 μ INCHES NICKEL

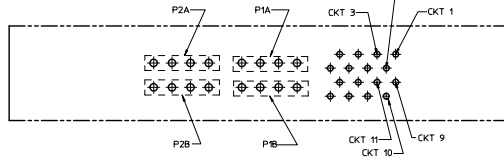

PCB LAYOUT: COMPONENT SIDE
SEE SHIT 1 FOR DIMENSIONS

QUALITY SYMBOLS	GENERAL TOLERANCES (UNLESS SPECIFIED)		DIMENSION STYLE	SCALE	DESIGN UNITS	THIRD ANGLE PROJECTION
	mm	INCH	MM/IN	4:1	METRIC	PROJECTION
▽=0	4 PLACES ±	±	MM/IN	DATE		
▽=0	3 PLACES ±	±0.10	DRAWN BY	07/18/07	TITLE	
▽=0	2 PLACES ±	±	CHECKED BY	DATE	LPH VERTICAL RECEPTACLE ASSEMBLY 4 CIRCUIT PWR CONNECTOR PRESS FIT	
▽=0	1 PLACE ±	±	APPROVED BY	DATE	molex	
▽=0	0 PLACE ±	±	J[COMERC]	2009/12/03	DOCUMENT NO. SD-46114-400	
ANGULAR ±1/2°			MATERIAL NO.	SEE CHART	SHEET NO. 3 OF 3	
DRAFT WHERE APPLICABLE MUST REMAIN WITHIN DIMENSIONS			THIS DRAWING CONTAINS INFORMATION THAT IS PROPRIETARY TO MOLEX INCORPORATED AND SHOULD NOT BE USED WITHOUT WRITTEN PERMISSION			