



**Distributor of Molex Connector Corporation: Excellent Integrated System Limited**  
Datasheet of 0873400423 - Connector Receptacle 4 Position 0.079" (2.00mm) Gold Surface  
Mount

Contact us: [sales@integrated-circuit.com](mailto:sales@integrated-circuit.com) Website: [www.integrated-circuit.com](http://www.integrated-circuit.com)

---

## **Excellent Integrated System Limited**

Stocking Distributor

Click to view price, real time Inventory, Delivery & Lifecycle Information:

[Molex Connector Corporation](#)  
[0873400423](#)

For any questions, you can email us directly:  
[sales@integrated-circuit.com](mailto:sales@integrated-circuit.com)

Contact us: sales@integrated-circuit.com Website: www.integrated-circuit.com

PART NO. IN TUBE	CKT. SIZE	DIM. B	DIM. A
87340-04**	4	2.00	4.00
87340-06**	6	4.00	6.00
87340-08**	8	6.00	8.00
87340-10**	10	8.00	10.00
87340-12**	12	10.00	12.00
87340-14**	14	12.00	14.00
87340-16**	16	14.00	16.00
87340-18**	18	16.00	18.00
87340-20**	20	18.00	20.00

- NOTES:  
 1. 12 CIRCUIT SIZE SHOWN FOR ILLUSTRATION ONLY. SEE CHART FOR AVAILABLE PART SIZES.  
 2. PLATING FINISH:  
 5 & 7 - 0.05um-0.25um GOLD IN CONTACT AREA  
 1.90um/75uin MIN. TIN IN SOLDER TAIL AREA  
 BOTH OVER 1.30um/50uin MIN. NICKEL OVERALL  
 3 & 8 - 0.76um/30uin MIN. GOLD IN CONTACT AREA  
 1.90um/75uin MIN. TIN IN SOLDER TAIL AREA  
 BOTH OVER 1.30um/50uin MIN. NICKEL OVERALL  
 4 & 9 - 0.38um/15uin MIN. GOLD IN CONTACT AREA  
 1.90um/75uin MIN. TIN IN SOLDER TAIL AREA  
 BOTH OVER 1.30um/50uin MIN. NICKEL OVERALL  
 3. COPLANARITY OF SOLDER TAIL IS TO BE MEASURED BY RESTING THE PART ON A FLAT GAUGE SURFACE.  
 4. PRODUCT SPECIFICATION PS-87340 APPLIES.  
 5. THIS AREA OF PART TO BE HEAT STAKED TO RETAIN CONTACTS.  
 6. PART IS MATEABLE TO ALL MILLI-GRID HEADERS WITH MINIMUM PIN LENGTHS OF 1.90mm FOR TOP ENTRY.

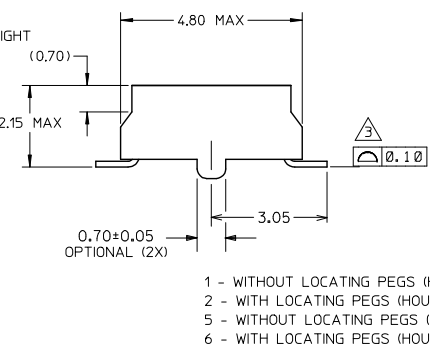
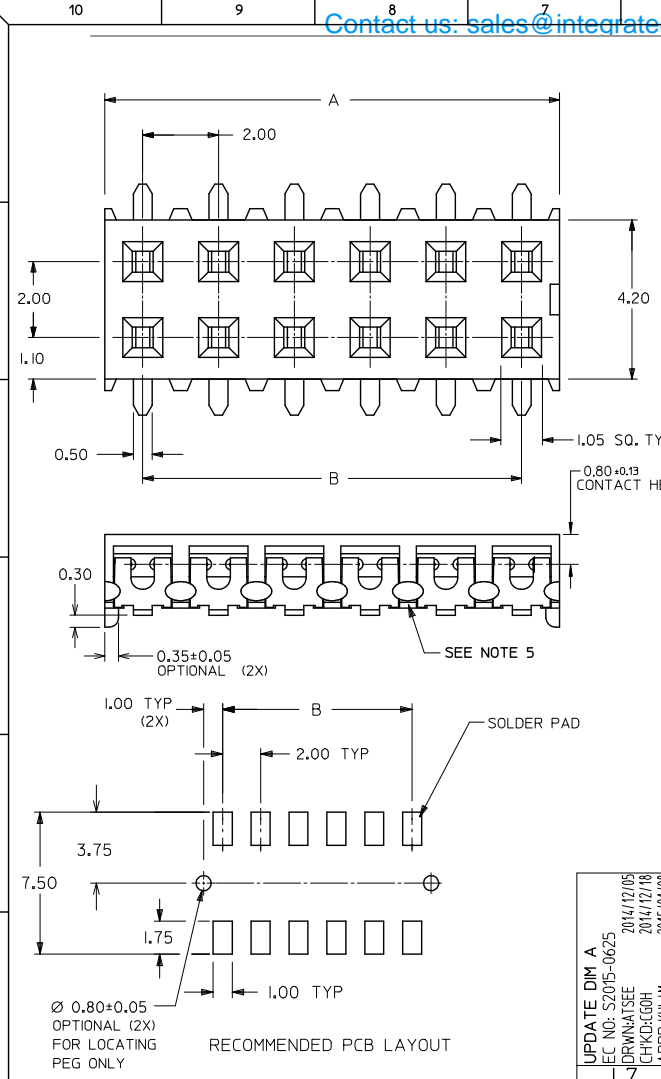

PART NO. LEGEND

87340 - \* \* \* \* \*

CIRCUIT SIZE

PACKAGING & PLATING

3 - (TUBE WITH 0.76um MIN GOLD)  
 4 - (TUBE WITH 0.38um MIN GOLD)  
 5 - (TUBE WITH 0.05-0.25um GOLD)  
 7 - (T&R WITH 0.05-0.25um GOLD)  
 8 - (T&R WITH 0.76um MIN GOLD)  
 9 - (T&R WITH 0.38um MIN GOLD)

1 - WITHOUT LOCATING PEGS (HOUSING - BLACK)  
 2 - WITH LOCATING PEGS (HOUSING - BLACK)  
 5 - WITHOUT LOCATING PEGS (HOUSING - NATURAL)  
 6 - WITH LOCATING PEGS (HOUSING - NATURAL)

QUALITY SYMBOLS	GENERAL TOLERANCES (UNLESS SPECIFIED)		DIMENSION STYLE		SCALE	DESIGN UNITS	THIRD ANGLE PROJECTION
	mm	INCH	MM ONLY	DATE			
∇=0	4 PLACES ± ---	± ---	DRAWN BY	1991/07/02	NTS	METRIC	MGRID VLPR II, 2MM DUAL ROW TOP ENTRY RECEPT., SMT
∇=0	3 PLACES ± ---	± ---	CHECKED BY	1991/07/09			
∇=0	2 PLACES ± 0.20	± ---	APPROVED BY	2009/11/24	Molex		MOLEX INCORPORATED
∇=0	1 PLACE ± ---	± ---	MATERIAL NO.	SEE TABLE	DOCUMENT NO.	SD-87340-**-01	SHEET NO. 1 OF 3
	ANGULAR ± 3°		DRAFT WHERE APPLICABLE MUST REMAIN WITHIN DIMENSIONS				

Contact us: [sales@integrated-circuit.com](mailto:sales@integrated-circuit.com) Website: [www.integrated-circuit.com](http://www.integrated-circuit.com)

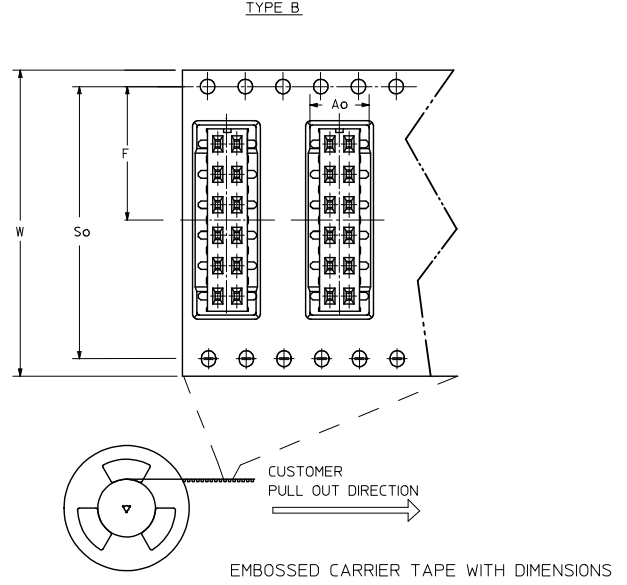
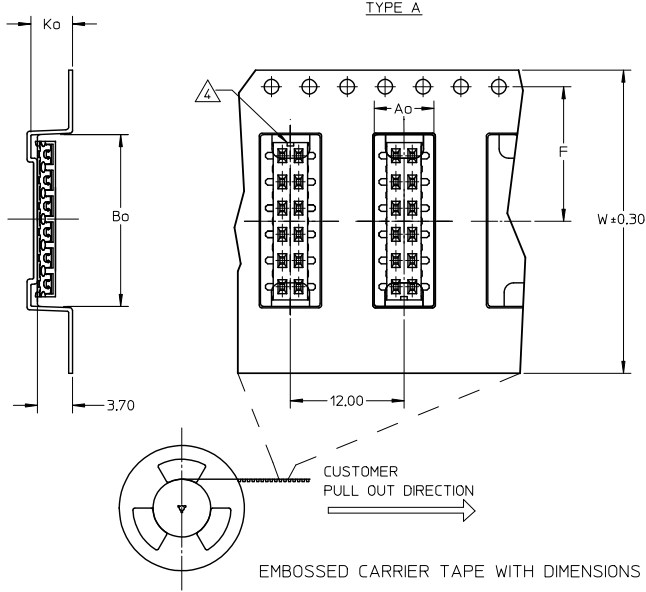

**NOTES:**

**1. LEADER AND TRAILER TAPE**

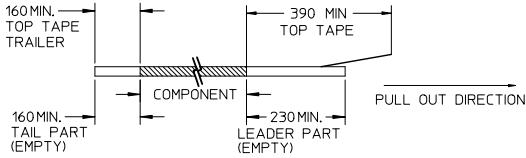

**2. PEELING OFF FORCE OF THE TOP TAPE: 20-80gf.**  
(PEELING DIRECTION AS SHOWN IN FOLLOWING FIGURE)

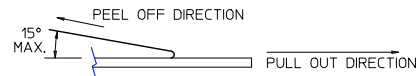

**3. PACKAGING STANDARD IS AS PER EIA-481.**

△ NO FIX ORIENTATION OF ASSEMBLY PART IN T&R.

**5. TAPE & REEL QUANTITY : TBA**

REMOVE DIM A MAX. EC. NO. S2015-0625 DRAWN/ISSUE 2014/12/05 CHKD:GOH 2014/12/18 APPR:KILLIM 2015/01/08	QUALITY SYMBOLS ▽=0 ▽=0 ▽=0	GENERAL TOLERANCES (UNLESS SPECIFIED)		DIMENSION STYLE MM ONLY		SCALE NTS	DESIGN UNITS METRIC	THIRD ANGLE PROJECTION	
		4 PLACES ± --- ± ---	3 PLACES ± --- ± ---	2 PLACES ± 0.20 ± ---	1 PLACE ± --- ± ---	ANGULAR ± 3 °	DRAWN BY JKACHLI	DATE 1991/07/02	TITLE MGRID VLPR II, 2MM DUAL ROW TOP ENTRY RECEPT., SMT
L7	DESCRIPTION REV	DRAFT WHERE APPLICABLE MUST REMAIN WITHIN DIMENSIONS		SEE TABLE		MATERIAL NO. MLONG	DATE 2009/11/24	MOLEX INCORPORATED	
		THIS DRAWING CONTAINS INFORMATION THAT IS PROPRIETARY TO MOLEX INCORPORATED AND SHOULD NOT BE USED WITHOUT WRITTEN PERMISSION		DOCUMENT NO. SD-87340-**-01		SHEET NO. 2 OF 3			

Contact us: [sales@integrated-circuit.com](mailto:sales@integrated-circuit.com) Website: [www.integrated-circuit.com](http://www.integrated-circuit.com)

PART NO. IN TUBE	PART NO. TAPE/REEL	CKT SIZE	Ao	Bo	F	W	Ko	So
87340-1014	87340-1019	10	6.70	10.40	11.50	24.00	5.30	-
87340-1613	87340-1618	16	6.60	16.30	11.50	24.00	4.40	-
87340-1424	87340-1429	14	6.60	14.40	11.50	24.00	4.40	-
87340-1813	87340-1818	18	6.60	18.40	14.20	32.00	4.40	28.40
87340-1814	87340-1819	18	6.60	18.40	14.20	32.00	4.40	28.40
87340-2024	87340-2029	20	6.60	20.30	20.20	44.00	5.40	40.40

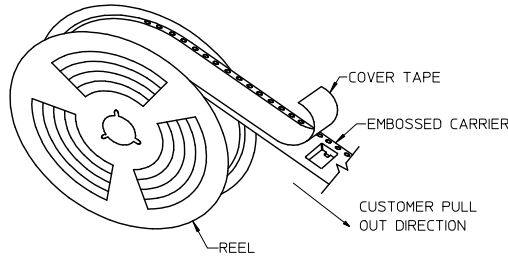

TAPE AND REEL ASSEMBLY SHOWN IS FOR ILLUSTRATION ONLY.

SEE SHT 1 EC. NO. S2015-0625 DRAWN BY: JDRW/ATSEE CHKD: GGH APPR: KILLIM 2014/12/05 2014/12/18 2015/01/08	QUALITY SYMBOLS √=0 √=0 √=0	GENERAL TOLERANCES (UNLESS SPECIFIED)		DIMENSION STYLE MM ONLY		SCALE NTS	DESIGN UNITS METRIC	THIRD ANGLE PROJECTION
		4 PLACES ± --- ± --- 3 PLACES ± --- ± --- 2 PLACES ± 0.20 ± --- 1 PLACE ± --- ± --- ANGULAR ± 3°	DRAWN BY: JKACHLI CHECKED BY: JNG APPROVED BY: MLONG DATE: 1991/07/02 DATE: 1991/07/09 DATE: 2009/11/24	TITLE MGRID VLPR II, 2MM DUAL ROW TOP ENTRY RECEPT., SMT MOLEX INCORPORATED			MATERIAL NO. SEE TABLE	DOCUMENT NO. SD-87340-**-01
DRAFT WHERE APPLICABLE MUST REMAIN WITHIN DIMENSIONS		THIS DRAWING CONTAINS INFORMATION THAT IS PROPRIETARY TO MOLEX INCORPORATED AND SHOULD NOT BE USED WITHOUT WRITTEN PERMISSION						