

Excellent Integrated System Limited

Stocking Distributor

Click to view price, real time Inventory, Delivery & Lifecycle Information:

[Molex Connector Corporation](#)
[0877581217](#)

For any questions, you can email us directly:

sales@integrated-circuit.com

10 9 8 7 6 5 4 3 2 1

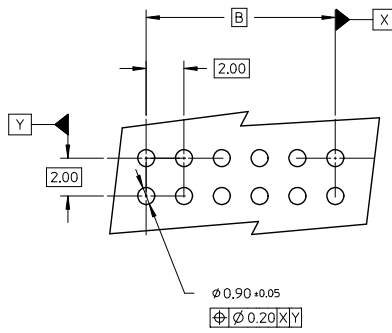
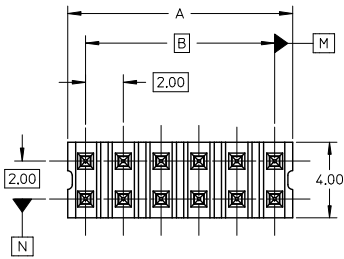

LEGEND
87758-****
CKT SIZE (SEE SHT 2 TABLE) PLATING (SEE NOTE 2)

NOTES:

- MATERIAL:
HOUSING: 30% G.F. NYLON 46, 94V-0, COLOR: BLACK
PIN: 0.50mm SQ. PHOSPHOR BRONZE 510
- PLATING:
 - **16 - 0.38um MIN GOLD IN CONTACT AREA, TIN IN SOLDER AREA, BOTH OVER NICKEL OVERALL.
 - **17 - 0.76um MIN GOLD IN CONTACT AREA, TIN IN SOLDER AREA, BOTH OVER NICKEL OVERALL.
 - **18 - 2.54um MIN TIN OVER NICKEL OVERALL.
 - **19 - 0.05-0.25um GOLD IN CONTACT AREA, TIN IN SOLDER AREA, BOTH OVER NICKEL OVERALL.
- 12 CKT USED FOR ILLUSTRATION ONLY
- PACKED IN POCKET TRAY
- PIN PUSHOUT FORCE: 1KG MIN IN EITHER DIRECTION
- CKT 4 AND 6 IS CUT FROM CKT 8 AND 12 RESPECTIVELY. CKT 2 ARE CUT FROM ANY LARGER CKT SIZE. ROUGH EDGES ARE EXPECTED ALONG THE CUTTING EDGES.
- PRODUCT SPEC PS-87761-100 APPLIES.
- RECOMMENDED PCB THICKNESS IS 1.60±0.10

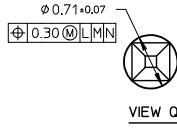
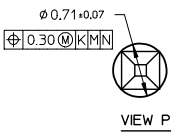
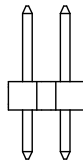
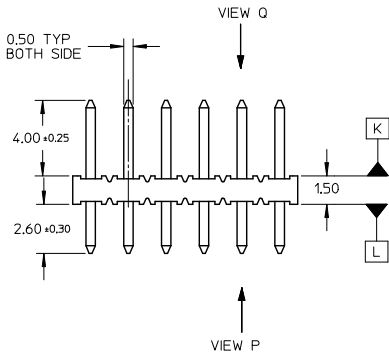

| | | | | | | | | | |
|--|---|--|--|-----------------------------------|----------------------|--------------------|---|---------------------------|-----------|
| ADD DATUMS EC NO: S2014-0031 DRAWN BY: CHYK-SKANG CHECKED BY: CHYK-SKANG APPR: M LONG 2013/07/08 2013/07/08 2013/07/10 | QUALITY SYMBOLS √=0 √=0 √=0 | GENERAL TOLERANCES (UNLESS SPECIFIED) | | DIMENSION STYLE MM ONLY | | SCALE NTS | DESIGN UNITS METRIC | THIRD ANGLE PROJECTION | |
| | | 4 PLACES ± --- ± --- | mm | INCH | DRAWN BY KSEE | DATE 2003/10/30 | SALES DRAWING 2MM DUAL ROW SINGLE WAFER, VERTICAL T/H HDR MOLEX INCORPORATED | | |
| | | 3 PLACES ± --- ± --- | mm | INCH | CHECKED BY KCLING | DATE 2004/01/05 | | | |
| | | 2 PLACES ± 0.20 ± --- | mm | INCH | APPROVED BY SKTOH | DATE 2004/01/05 | MATERIAL NO. | DOCUMENT NO. | SHEET NO. |
| 1 PLACE ± --- ± --- | mm | INCH | DRAFT WHERE APPLICABLE MUST REMAIN WITHIN DIMENSIONS | | SEE TABLE | SD-87758-107 | 1 OF 2 | | |

9 8 7 6 5 4 3 2 1

| PART NUMBER | CKT SIZE | A | B |
|-------------|----------|-------|-------|
| 87758-02** | 2 | NA | NA |
| 87758-04** | 4 | NA | 2.00 |
| 87758-06** | 6 | NA | 4.00 |
| 87758-08** | 8 | 7.90 | 6.00 |
| 87758-10** | 10 | 9.90 | 8.00 |
| 87758-12** | 12 | 11.90 | 10.00 |
| 87758-14** | 14 | 13.90 | 12.00 |
| 87758-16** | 16 | 15.90 | 14.00 |
| 87758-18** | 18 | 17.90 | 16.00 |
| 87758-20** | 20 | 19.90 | 18.00 |
| 87758-22** | 22 | 21.90 | 20.00 |
| 87758-24** | 24 | 23.90 | 22.00 |
| 87758-26** | 26 | 25.90 | 24.00 |
| 87758-28** | 28 | 27.90 | 26.00 |
| 87758-30** | 30 | 29.90 | 28.00 |
| 87758-32** | 32 | 31.90 | 30.00 |
| 87758-34** | 34 | 33.90 | 32.00 |
| 87758-36** | 36 | 35.90 | 34.00 |
| 87758-38** | 38 | 37.90 | 36.00 |
| 87758-40** | 40 | 39.90 | 38.00 |
| 87758-42** | 42 | 41.90 | 40.00 |
| 87758-44** | 44 | 43.90 | 42.00 |
| 87758-46** | 46 | 45.90 | 44.00 |
| 87758-48** | 48 | 47.90 | 46.00 |
| 87758-50** | 50 | 49.90 | 48.00 |

| CKT SIZE | PART NO. WITH CAP IN TUBE | PART NO. WITH CAP IN TAPE/REEL | PLATING TYPE |
|----------|---------------------------|--------------------------------|--------------|
| 8 | 87758-0814 | 87758-0815 | **16 |
| 22 | 87758-5126 | 87758-5111 | MOLEX INC. |

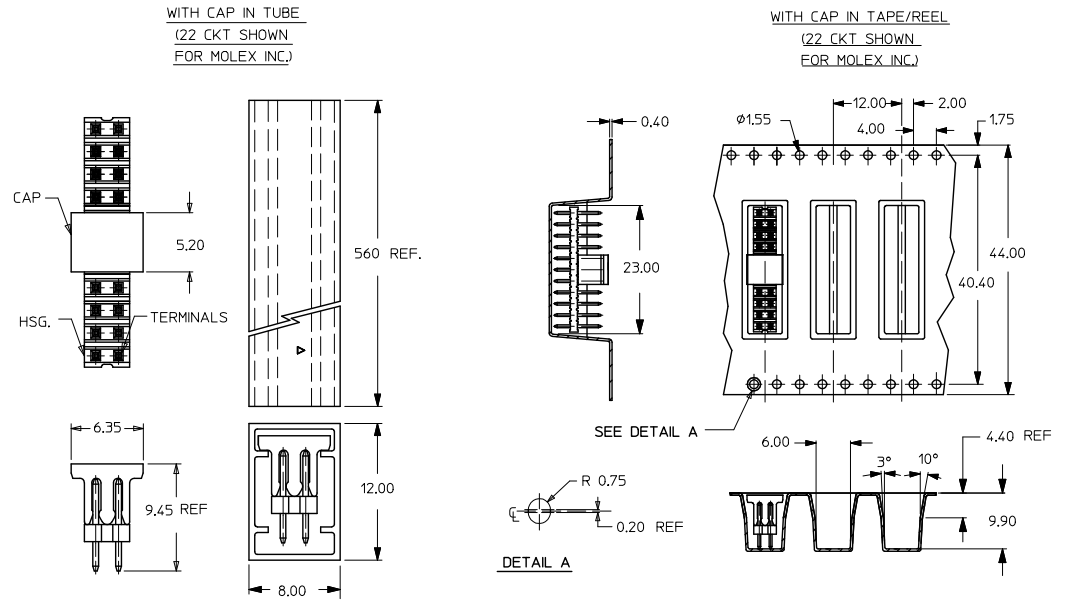

| ADD DATUMS | EC NO. | DATE | DESCRIPTION |
|------------|------------|------------|-------------|
| A4 | S2014-0031 | 2013/07/08 | ADD DATUMS |
| | DRW:ALSEE | 2013/07/08 | DRAWN/ISSUE |
| | CHK:SKANG | 2013/07/10 | CHECKED |
| | APPR:HLONG | 2013/07/10 | APPROVED |

| QUALITY SYMBOLS | GENERAL TOLERANCES (UNLESS SPECIFIED) | DIMENSION STYLE | SCALE | DESIGN UNITS | THIRD ANGLE PROJECTION |
|--|--|---|--------------------|---------------------------|------------------------|
| $\nabla=0$ $\nabla=0$ $\nabla=0$ | 4 PLACES ± --- ± --- 3 PLACES ± --- ± --- 2 PLACES ± 0.20 ± --- 1 PLACE ± --- ± --- ANGULAR ± 3° | MM ONLY | NTS | METRIC | THIRD ANGLE PROJECTION |
| DRAFT WHERE APPLICABLE MUST REMAIN WITHIN DIMENSIONS | | SEE TABLE | MATERIAL NO. SKTOH | | |
| DRAWN BY: KSEE DATE: 2003/10/30 | | TITLE: SALES DRAWING 2MM DUAL ROW SINGLE WAFER, VERTICAL T/H HDR | | | |
| CHECKED BY: KCLING DATE: 2004/01/05 | | APPROVED BY: SKTOH DATE: 2004/01/05 | | | |
| APPROVED BY: SKTOH DATE: 2004/01/05 | | MOLEX INCORPORATED | | DOCUMENT NO. SD-87758-107 | |
| SIZE: A3 | | THIS DRAWING CONTAINS INFORMATION THAT IS PROPRIETARY TO MOLEX INCORPORATED AND SHOULD NOT BE USED WITHOUT WRITTEN PERMISSION | | | SHEET NO. 2 OF 2 |