

Excellent Integrated System Limited

Stocking Distributor

Click to view price, real time Inventory, Delivery & Lifecycle Information:

[Molex Connector Corporation](#)
[0877592015](#)

For any questions, you can email us directly:
sales@integrated-circuit.com

10 9 8 7 6 5 4 3 2 1

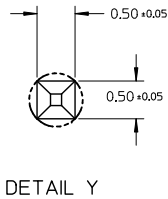
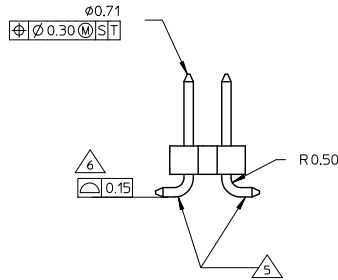
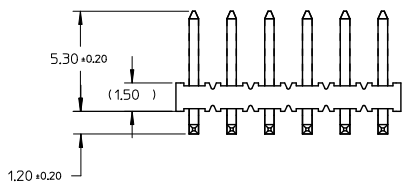
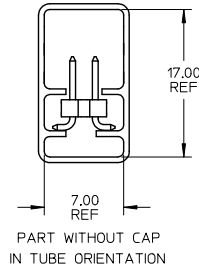
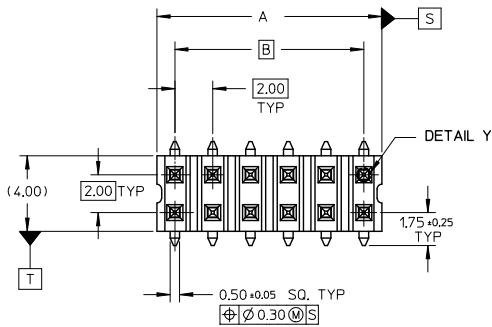

NOTE:

1. MATERIAL:
HSG & CAP - NYLON
UL 94V-0, COLOUR BLACK
PIN - 0.50 SQ PHOSPHOR BRONZE
2. PLATING:
0.76µm MIN GOLD PLATE AT CONTACT AREA.
TIN PLATE AT SOLDER AREA.
BOTH OVER NICKEL UNDERPLATE
3. PIN PUSHOUT FORCE: 1KG MIN IN EITHER DIRECTION
4. PRODUCT SPEC PS-87761-100 APPLIES.
5. BEND DEPRESSION IS ACCEPTABLE SO LONG AS IT DOES NOT AFFECT THE OVERALL COPLANARITY OF TAIL.
6. COPLANARITY IS TO BE MEASURED BY RESTING THE SOLDER TAIL ON A FLAT SURFACE.
7. CAP TO BE LOCATED AS CENTRAL OF PART AS POSSIBLE TOP SURFACE OF CAP TO BE FLAT FOR THE PURPOSE OF PICK & PLACE BY VACUUM SUCTION NOZZLE.
8. FOR ILLUSTRATION PURPOSES, 12CKT IS SHOWN.
9. CKT 4 & 6 IS CUT FROM CKT 8 & 12 RESPECTIVELY ROUGH EDGES ARE EXPECTED ALONG THE CUTTING EDGES.
10. PART TO BE PACKED IN TRAY 10 ONLY.
11. TUBE LENGTH IS 560MM REF STANDARD.

SEE SHEET 4 EC NO: S2016-1073 DRAWN BY: 2016/05/19 CHKD: SCHEONG 2016/06/03 APPR: KILLIM 2016/06/06	QUALITY SYMBOLS √=0 ∇=0 ∇=0	GENERAL TOLERANCES (UNLESS SPECIFIED)		DIMENSION STYLE MM ONLY		SCALE NTS	DESIGN UNITS METRIC	THIRD ANGLE PROJECTION
		4 PLACES ± --- ± --- 3 PLACES ± --- ± --- 2 PLACES ± 0.20 ± --- 1 PLACE ± --- ± --- 0 PLACE ± --- ± ---	mm INCH	DRAWN BY: KSEE DATE: 2003/12/17	CHECKED BY: KCLING DATE: 2004/01/12	TITLE MGRID, 2MM DUAL ROW HEADER, SMT		
DRAFT WHERE APPLICABLE MUST REMAIN WITHIN DIMENSIONS		ANGULAR ± 3°		MATERIAL NO. SEE TABLE		DOCUMENT NO. SD-87759-118		SHEET NO. 1 OF 4
THIS DRAWING CONTAINS INFORMATION THAT IS PROPRIETARY TO MOLEX INCORPORATED AND SHOULD NOT BE USED WITHOUT WRITTEN PERMISSION								

9 8 7 6 5 4 3 2 1

10 9 8 7 6 5 4 3 2 1

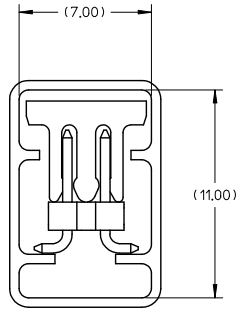
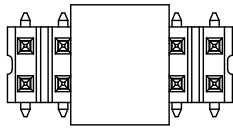
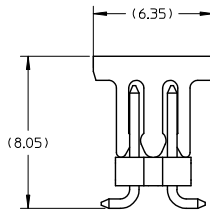
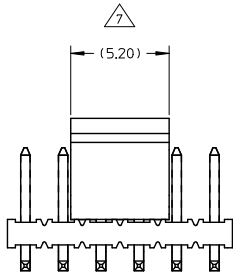

PART WITH CAP IN
TUBE ORIENTATION

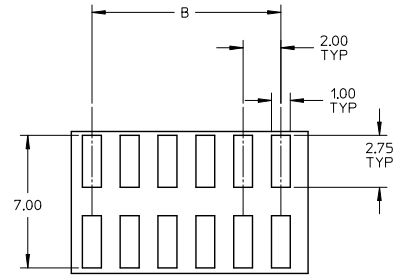

RECOMMENDED SOLDER PAD LAYOUT

SEE SHEET 4 EC NO: S2016-1073 DRAWN: MEMIRLY CHKD: SCHEONG APPR: KHLIN	2016/05/19 2016/06/03 2016/06/06	QUALITY SYMBOLS	GENERAL TOLERANCES (UNLESS SPECIFIED)		DIMENSION STYLE MM ONLY		SCALE NTS	DESIGN UNITS METRIC	THIRD ANGLE PROJECTION	
		$\nabla=0$ $\nabla=0$ $\nabla=0$	4 PLACES	±	---	mm	INCH	DRAWN BY KSEE	DATE 2003/12/17	TITLE MGRID, 2MM DUAL ROW HEADER, SMT
			3 PLACES	±	---			CHECKED BY KCLING	DATE 2004/01/12	
			2 PLACES	±	0.20			APPROVED BY SKTOH	DATE 2004/01/12	
		1 PLACE	±	---						
		0 PLACE	±	---						
		ANGULAR ± 3°		MATERIAL NO.		SEE TABLE		DOCUMENT NO.	SHEET NO.	
		DRAFT WHERE APPLICABLE MUST REMAIN WITHIN DIMENSIONS		SIZE A3		THIS DRAWING CONTAINS INFORMATION THAT IS PROPRIETARY TO MOLEX INCORPORATED AND SHOULD NOT BE USED WITHOUT WRITTEN PERMISSION		SD-87759-118	2 OF 4	

9 8 7 6 5 4 3 2 1

10 9 8 7 6 5 4 3 2 1

EMBOSSED CARRIER TAPE TYPE 'A'

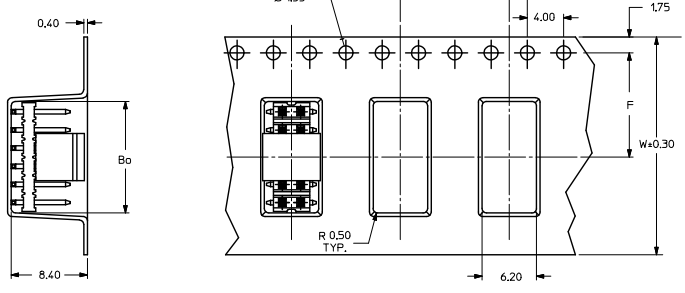

EMBOSSED CARRIER TAPE TYPE 'B'

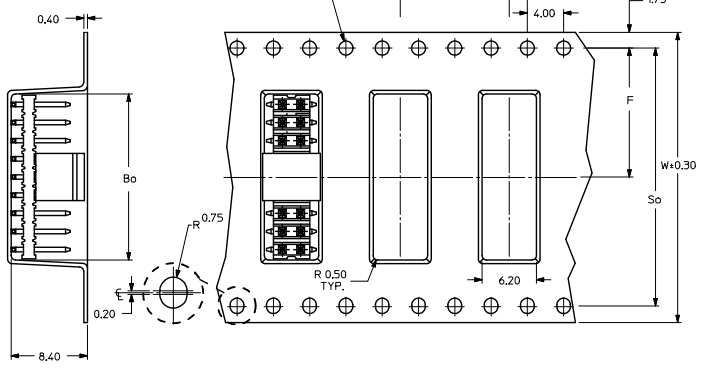

EMBOSSED CARRIER TAPE TYPE 'C'

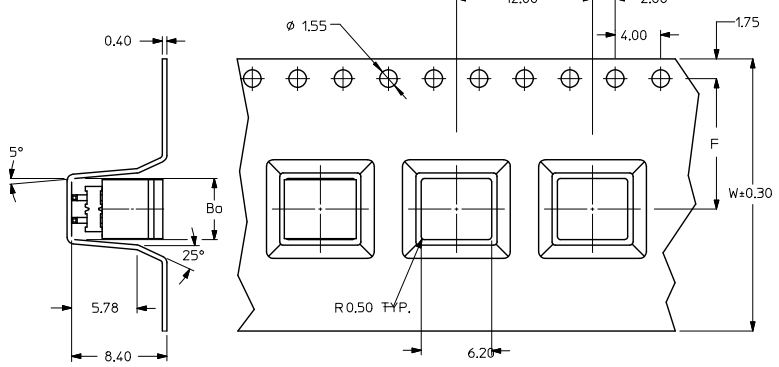

THIS TYPE OF CARRIER IS FOR CKT SIZE 8 AND BELOW.

SEE SHEET 4 EC NO: S2016-1073 DRAWN BY: CHYK-SHEUNG CHECKED BY: SKTOH APPR: KILLIN	QUALITY SYMBOLS	GENERAL TOLERANCES (UNLESS SPECIFIED)	DIMENSION STYLE	SCALE	DESIGN UNITS	THIRD ANGLE PROJECTION
	▽=0	mm INCH	MM ONLY	NTS	METRIC	
	▽=0	4 PLACES ± --- ± ---	DRAWN BY DATE	TITLE	MGRID, 2MM DUAL ROW HEADER, SMT	
	▽=0	3 PLACES ± --- ± ---	KSEE 2003/12/17		molex	
▽=0	2 PLACES ± 0.20 ± ---	CHECKED BY DATE		DOCUMENT NO.	SD-87759-118	SHEET NO. 3 OF 4
▽=0	1 PLACE ± --- ± ---	KCLING 2004/01/12		THIS DRAWING CONTAINS INFORMATION THAT IS PROPRIETARY TO MOLEX INCORPORATED AND SHOULD NOT BE USED WITHOUT WRITTEN PERMISSION		
REV	DESCRIPTION	ANGULAR ± 3 °	MATERIAL NO.			
B2		DRAFT WHERE APPLICABLE MUST REMAIN WITHIN DIMENSIONS	SEE TABLE			

9 8 7 6 5 4 3 2 1



	10	9	8	7	6	5	4	3	2	1	
	PART NUMBER WITHOUT CAP IN TUBE	PART NUMBER WITH CAP IN TUBE	PART NUMBER WITH CAP IN TAPE AND REEL.	CKT SIZE	A	B	Bo	F	So	W	EMBOSSED TYPE
F	87759-0415	87759-0465	87759-0475	4	3.90±0.38	2.00	5.40	11.50	-	24.00	C
	87759-0615	87759-0665	87759-0675	6	5.90±0.38	4.00	7.20	11.50	-	24.00	C
	87759-0815	87759-0865	87759-0875	8	7.90±0.20	6.00	8.20	11.50	-	24.00	C
	87759-1015	87759-1065	87759-1075	10	9.90±0.20	8.00	10.20	11.50	-	24.00	A
	87759-1215	87759-1265	87759-1275	12	11.90±0.20	10.00	12.20	11.50	-	24.00	A
E	87759-1415	87759-1465	87759-1475	14	13.90±0.20	12.00	14.20	11.50	-	24.00	A
	87759-1615	87759-1665	87759-1675	16	15.90±0.20	14.00	16.20	14.20	28.40	32.00	B
	87759-1815	87759-1865	87759-1875	18	17.90±0.20	16.00	18.20	14.20	28.40	32.00	B
	87759-2015	87759-2065	87759-2075	20	19.90±0.20	18.00	20.20	14.20	28.40	32.00	B
	87759-2215	87759-2265	87759-2275	22	21.90±0.20	20.00	22.20	20.20	40.40	44.00	B
	87759-2415	87759-2465	87759-2475	24	23.90±0.20	22.00	24.20	20.20	40.40	44.00	B
D	87759-2615	87759-2665	87759-2675	26	25.90±0.20	24.00	26.20	20.20	40.40	44.00	B
	87759-2815	87759-2865	87759-2875	28	27.90±0.20	26.00	28.20	20.20	40.40	44.00	B
	87759-3015	87759-3065	87759-3075	30	29.90±0.20	28.00	30.20	20.20	40.40	44.00	B
	87759-3215	87759-3265	87759-3275	32	31.90±0.20	30.00	32.20	20.20	40.40	44.00	B
	87759-3415	87759-3465	87759-3475	34	33.90±0.20	32.00	34.20	26.20	52.40	56.00	B
	87759-3615	87759-3665	87759-3675	36	35.90±0.20	34.00	36.20	26.20	52.40	56.00	B
	87759-3815	87759-3865	87759-3875	38	37.90±0.20	36.00	38.20	26.20	52.40	56.00	B
C	87759-4015	87759-4065	87759-4075	40	39.90±0.20	38.00	40.20	26.20	52.40	56.00	B
	87759-4215	87759-4265	87759-4275	42	41.90±0.20	40.00	42.20	26.20	52.40	56.00	B
	87759-4415	87759-4465	87759-4475	44	43.90±0.20	42.00	44.20	26.20	52.40	56.00	B
	87759-4615	87759-4665	87759-4675	46	45.90±0.20	44.00	46.20	26.20	52.40	56.00	B
	87759-4815	87759-4865	87759-4875	48	47.90±0.20	46.00	48.20	26.20	52.40	56.00	B
B	87759-5015	87759-5065	87759-5075	50	49.90±0.20	48.00	50.20	34.20	68.40	72.00	B

ADD DIM A FOR FILE NO. 2016-1073 DRAWN BY: MARY 2016/05/19 CHECKED BY: SCHEONG 2016/06/03 APPR: KHLIN 2016/06/06	QUALITY SYMBOLS	GENERAL TOLERANCES (UNLESS SPECIFIED)	DIMENSION STYLE	SCALE	DESIGN UNITS	THIRD ANGLE PROJECTION
	$\sqrt{\text{ }}=0$	mm INCH	MM ONLY	NTS	METRIC	
	$\sqrt{\text{ }}=0$	4 PLACES ± --- ± ---	DRAWN BY DATE	TITLE		
	$\sqrt{\text{ }}=0$	3 PLACES ± --- ± ---	KSEE 2003/12/17	MGRID, 2MM DUAL ROW HEADER, SMT		
	2 PLACES ± 0.20 ± ---	CHECKED BY DATE				
	1 PLACE ± --- ± ---	KCLING 2004/01/12				
	0 PLACE ± ±	APPROVED BY DATE	DOCUMENT NO.			
		SKTOH 2004/01/12	SD-87759-118			
			SHEET NO. 4 OF 4			
			MATERIAL NO. SEE TABLE			
			THIS DRAWING CONTAINS INFORMATION THAT IS PROPRIETARY TO MOLEX INCORPORATED AND SHOULD NOT BE USED WITHOUT WRITTEN PERMISSION			