

Excellent Integrated System Limited

Stocking Distributor

Click to view price, real time Inventory, Delivery & Lifecycle Information:

[Wurth Electronics Inc](#)
[744878008](#)

For any questions, you can email us directly:

sales@integrated-circuit.com

Spezifikation für Freigabe / specification for release

Kunde / customer :
 Artikelnummer / part number : **744878008**
 Bezeichnung : **DOPPELDROSSEL WE-DD**
 description : **POWER-CHOKE WE-DD**



DATUM / DATE : 2011-04-19

A Mechanische Abmessungen / dimensions :

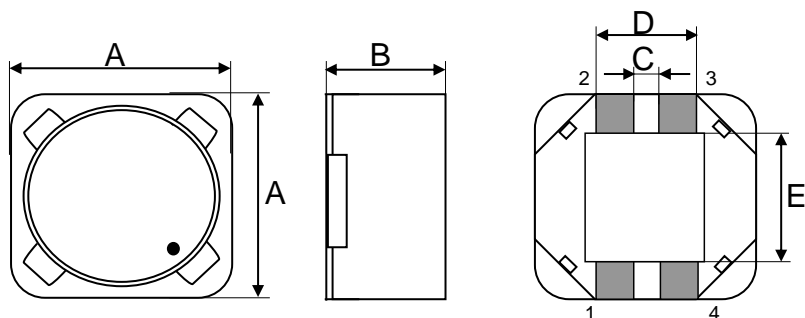

Typ S		
A	7,3 ± 0,4	mm
B	4,0 max.	mm
C	1,0 ± 0,1	mm
D	2,7 ± 0,1	mm
E	4,0 ± 0,2	mm
F	4,0 ± 0,2	mm

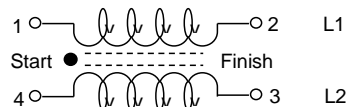

B Elektrische Eigenschaften / electrical properties :

C Lötpad / soldering spec.:

Eigenschaften / properties	Testbedingungen / test conditions		Wert / value	Einheit / unit	tol.
Induktivität (je Wicklg.) / inductance (each wdg.)	1 kHz / 0,25V	L_1, L_2	8,2	μH	±20%
DC-Widerstand (je Wicklg.) / DC-resistance (each wdg.)	@ 20°	$R_{DC1,2}$	0,115	Ω	typ.
DC-Widerstand (je Wicklg.) / DC-resistance (each wdg.)	@ 20°	$R_{DC1,2}$	0,140	Ω	max.
Nennstrom (je Wicklg.) / rated Current (each wdg.)	$\Delta T = 40 \text{ K}$	I_{N1}, I_{N2}	1,30	A	max.
Sättigungsstrom (je Wicklg.) / saturation current (each wdg.)	$\Delta L/L < 10\%$	I_{sat}	2,70	A	max.
Eigenres.-Frequenz / self-res.-frequency		SRF	22	MHz	typ.
Nennspannung / rated voltage		U_{DC}	80	V	max.

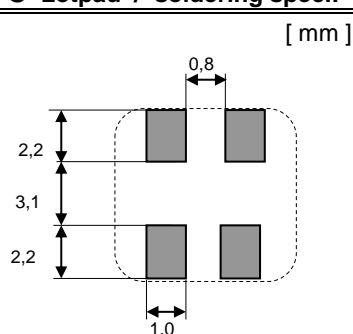

D Prüfgeräte / test equipment :

HP 4274 A für/for L und/and Q
HP 34401 A für/for I_{DC} und/and R_{DC}

E Testbedingungen / test conditions :

Luftfeuchtigkeit / humidity: 33%
 Umgebungstemperatur / temperature: +20°C

F Werkstoffe & Zulassungen / material & approvals :

Basismaterial / base material: Ferrit/ ferrite
 Draht / wire: 2 SFBW; 155°C

G Eigenschaften / general specifications :

Betriebstemp. / operating temperature: -40°C - + 125°C
 Umgebungstemp. / ambient temperature: -40°C - + 85°C
 It is recommended that the temperature of the part does not exceed 125°C under worst case operating conditions.

Freigabe erteilt / general release:	Kunde / customer			
.....			
Datum / date	Unterschrift / signature			
	Würth Elektronik			
.....			
Geprüft / checked	Kontrolliert / approved	SVS	Version 1	11-04-20
		Name	Änderung / modification	Datum / date

Würth Elektronik eiSos GmbH & Co.KG

Spezifikation für Freigabe / specification for release

Kunde / customer :

Artikelnummer / part number : **744878008**

LF



Bezeichnung : **DOPPELDROSSEL WE-DD**

description : **POWER-CHOKE WE-DD**

WÜRTH ELEKTRONIK

DATUM / DATE : 2011-04-19

H Induktivitätskurve / Inductance curve:

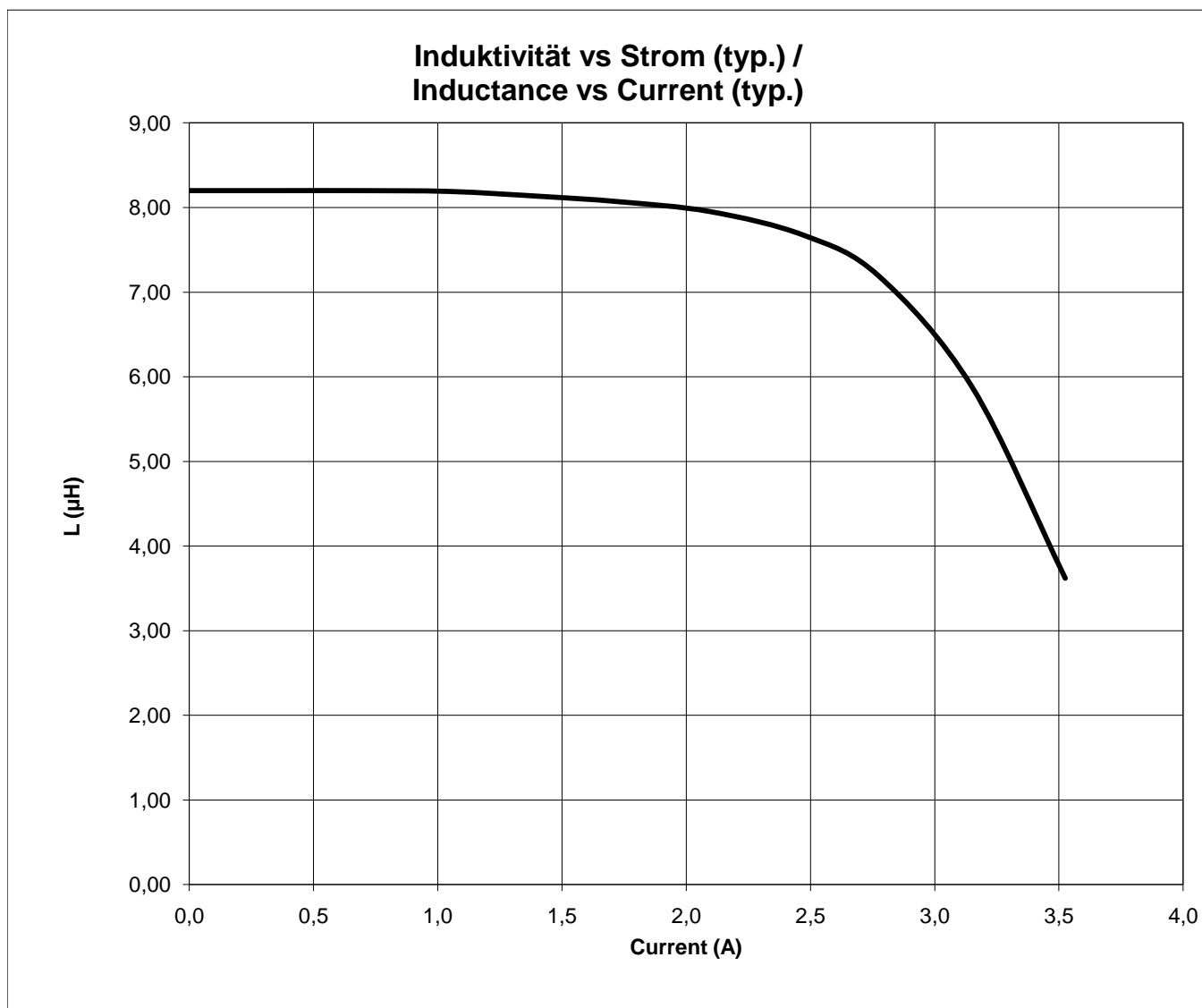

Freigabe erteilt / general release:	Kunde / customer			
Datum / date	Unterschrift / signature			
	Würth Elektronik			
Geprüft / checked	Kontrolliert / approved	Name	Änderung / modification	Datum / date
		SVS	Version 1	11-04-20

Würth Elektronik eiSos GmbH & Co.KG

Spezifikation für Freigabe / specification for release

Kunde / customer :

Artikelnummer / part number : **744878008**

LF



Bezeichnung : **DOPPELDROSSEL WE-DD**
description : **POWER-CHOKE WE-DD**

WÜRTH ELEKTRONIK

DATUM / DATE : 2011-04-19

I Rollenspezifikation / tape and reel specification:

Gurtspezifikation / Tape specification:

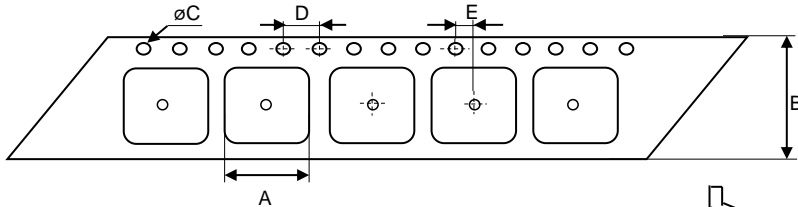

A	9,00 ± 0,1	mm
B	16,0 ± 0,2	mm
C	1,50 +0,1 - 0,0	mm
D	4,00 ± 0,1	mm
E	2,00 ± 0,1	mm
F	9,00 ± 0,1	mm
G	3,50 ± 0,1	mm

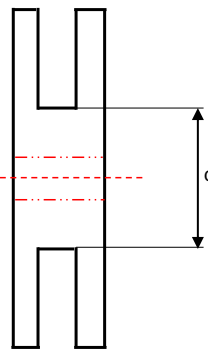
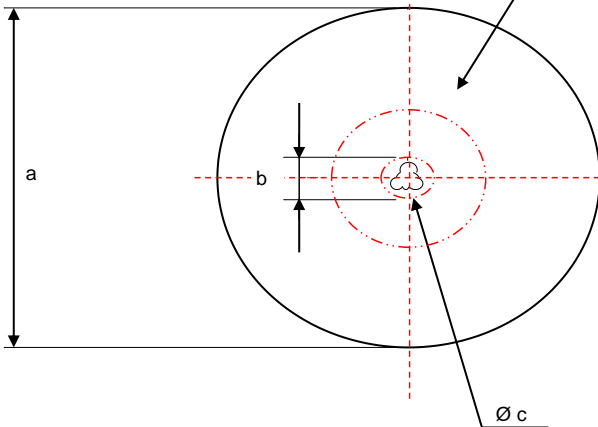
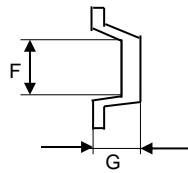

Rollenspezifikation / Reel specification:

a	330,0 ± 2,0	mm
b	21,00 ± 0,8	mm
c	13,00 ± 0,5	mm
d	100,0 ± 1,0	mm

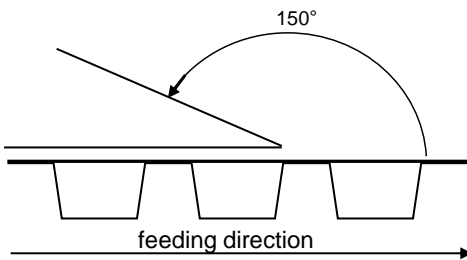

The force for tearing off cover tape is 20 to 70 grams in arrow direction

Freigabe erteilt / general release:	Kunde / customer		
Datum / date	Unterschrift / signature		
	Würth Elektronik		
Geprüft / checked	Kontrolliert / approved		
	SVS	Version 1	11-04-20
	Name	Änderung / modification	Datum / date

This electronic component has been designed and developed for usage in general electronic equipment. Before incorporating this component into any equipment where higher safety and reliability is especially required or if there is the possibility of direct damage or injury to human body, for example in the range of aerospace, aviation, nuclear control, submarine, transportation, (automotive control, train control, ship control), transportation signal, disaster prevention, medical, public information network etc. Würth Elektronik eiSos GmbH must be informed before the design-in stage. In addition, sufficient reliability evaluation checks for safety must be performed on every electronic component which is used in electrical circuits that require high safety and reliability functions or performance.

Würth Elektronik eiSos GmbH & Co.KG