

Excellent Integrated System Limited

Stocking Distributor

Click to view price, real time Inventory, Delivery & Lifecycle Information:

[Hirose Electric Co Ltd](#)
[FX20-120P-0.5SV15](#)

For any questions, you can email us directly:

sales@integrated-circuit.com



FX20 Series

0.5 mm Pitch, Double Beam Contacts,
 Floating Stacking Connectors



◆ Features

1. ± 0.6 mm Min. floating in XY directions
2. Self-cleaning function and vibration resistance with double beam contact
3. Current capacity: 0.5 Amp / pin
4. Available in 15, 20, 25 and 30 mm PCB distance
5. ± 1.2 mm self-alignment structure for easy mating
6. Contacts of both header and receptacle are enclosed in the housing for dust protection.
7. No flowable material penetration to the contacts with capillary action prevention structure
8. RoHS compliant

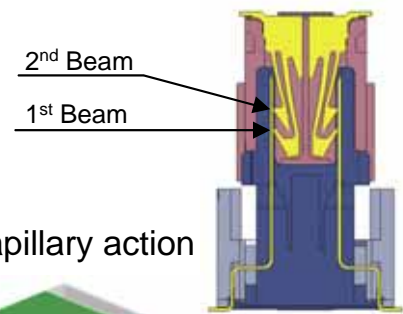

◆ Floating Range

Y Direction: ± 0.6 mm
 X Direction: ± 0.6 mm (15 & 25 mm Mated Height)
 ± 0.8 mm (20 & 30 mm Mated Height)

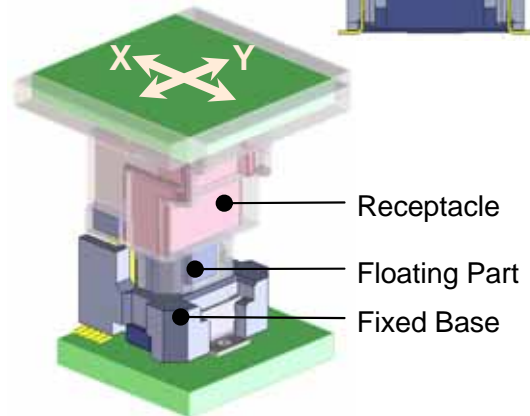

◆ Variation

■ Receptacle

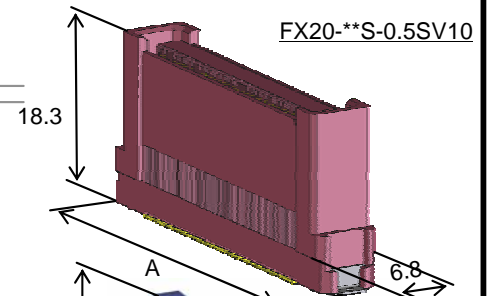
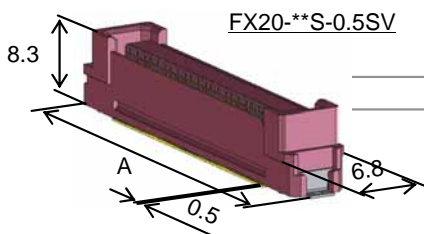

■ Header

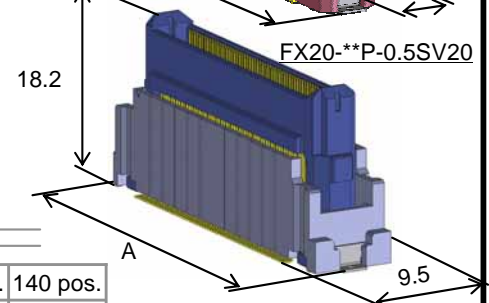
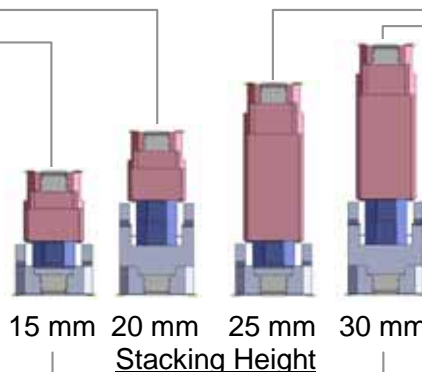
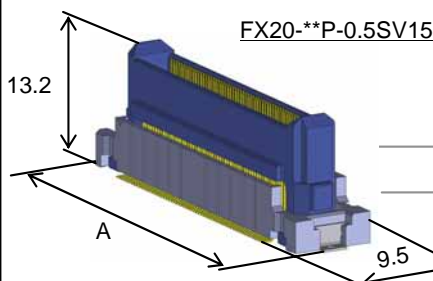

	40 pos.	60 pos.	80 pos.	100 pos.	120 pos.	140 pos.
A	22.4	27.4	32.4	37.4	42.4	47.4

(All dimensions in millimeter)

Specifications herein are subject to change without notice. Contact Hirose for latest specifications, drawings or availabilities.