

Excellent Integrated System Limited

Stocking Distributor

Click to view price, real time Inventory, Delivery & Lifecycle Information:

[Molex Connector Corporation](#)
[0861070000](#)

For any questions, you can email us directly:

sales@integrated-circuit.com

PART N	COLOR
86107-0000	BLACK
86107-0100	BEIGE

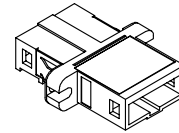
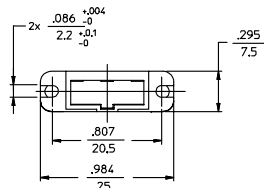
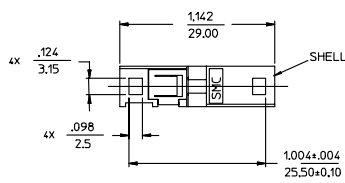

ISO FRONT VIEW

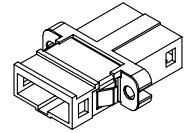

ISO BACK VIEW

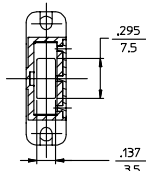
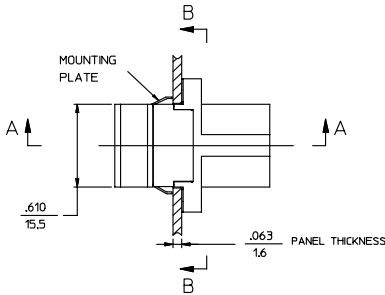

SECTION B-B

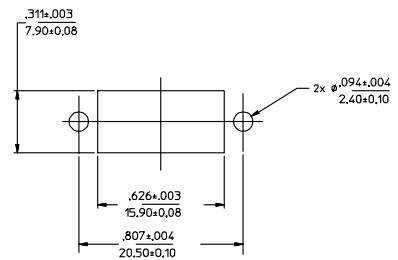

RECOMMENDED MOUNTING HOLE

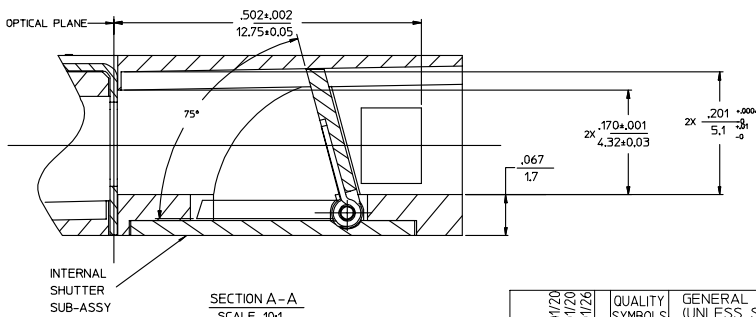

SECTION A-A
SCALE 10:1

NOTES:

1. ALL DIMENSIONS ARE IN $\frac{\text{INCHES}}{\text{MM}}$.
2. ALL DIMENSIONS EXCEPT FOR MOUNTING HOLE ARE FOR REFERENCE.

EIC NO: MF2005-0417 DRAWN BY: VENERZ05/01/20 CHKD: 2005/01/20 APPR: GJMIN 2005/01/26	QUALITY SYMBOLS ▽-0 ▽-0	GENERAL TOLERANCES (UNLESS SPECIFIED) 4 PLACES ± .005 3 PLACES ± 0.13 ± .005 2 PLACES ± 0.38 ± .015 1 PLACE ± .005	SCALE 100:10 DESIGN UNITS INCH DIMENSION STYLE IN/MM	THIRD ANGLE PROJECTION REVISE ON CAD ONLY
		DRAFT WHERE APPLICABLE MUST REMAIN WITHIN DIMENSIONS	DRAWN BY NG DATE 2002.02.26 CHECKED BY YGB DATE 2002.02.26 APPROVED BY ILG DATE 2002.02.27	TITLE SMC ADAPTER MOLEX INCORPORATED MATERIAL NO. SEE TABLE SD-86107-0X00 DOCUMENT NO. 1 OF 1 SHEET NO. 1 OF 1