

Excellent Integrated System Limited

Stocking Distributor

Click to view price, real time Inventory, Delivery & Lifecycle Information:

[Olimex LTD](#)
[AVR-H128-CAN](#)

For any questions, you can email us directly:

sales@integrated-circuit.com

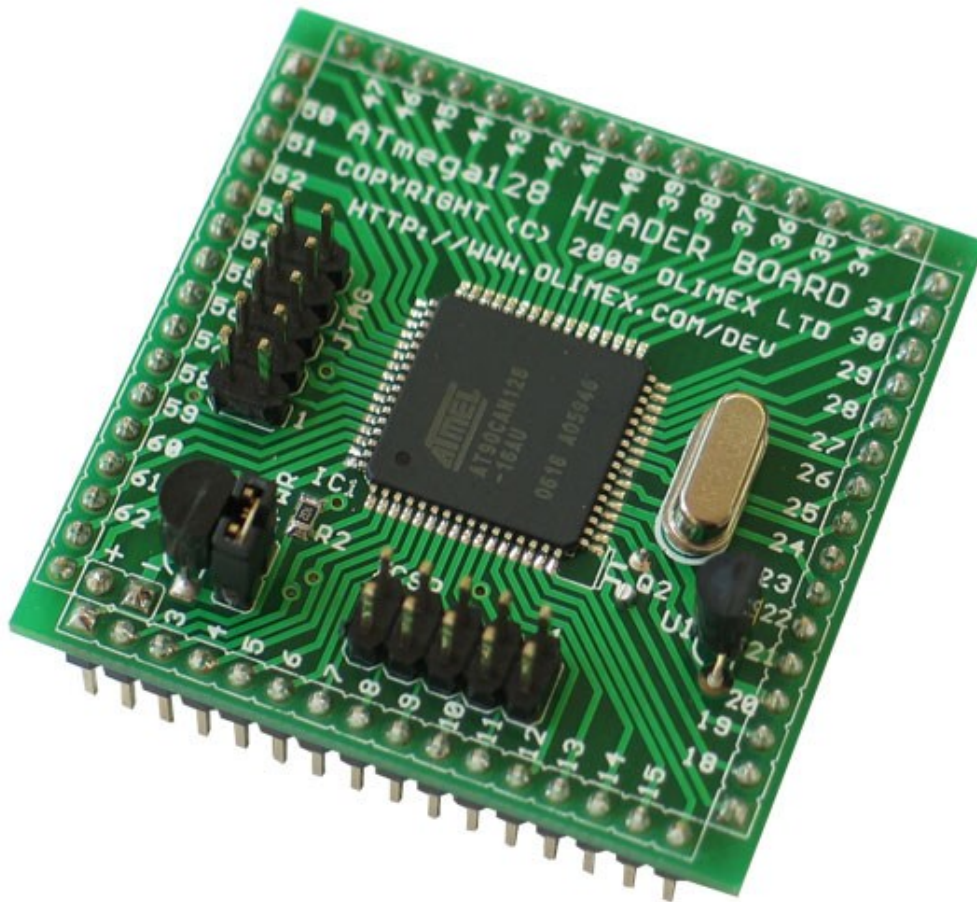

AVR- H128-CAN development board

Users Manual



All boards produced by Olimex are ROHS compliant

Rev.A, January 2005
Copyright(c) 2009, OLIMEX Ltd, All rights reserved

INTRODUCTION

AVR-H128-CAN is inexpensive way to develop and prototype circuits with AT90CAN128 without need to deal with SMD soldering. All microcontroller pins are available on extension header with 0.1" and power supply, oscillators, ICSP, JTAG are wired, so all you need to do is to connect your additional components to the AVR ports, as the step is 0.1" these headers perfectly fit the prototype sea of pad boards with 0.1" step.

BOARD FEATURES

- AT90CAN128-16AU microcontroller with 128KB Flash, 4KB RAM, 4KB EEPROM, CAN controller
- ICSP 5x2 pin connector for in-circuit programming with AVR-PG1 or AVR-PG2 or STK500 compatible programmer
- JTAG 5x2 pin connector for in-circuit debugging with AVR-JTAG-L or AVR-JTAG-USB
- 16MHz scillator circuit
- 32768 Hz oscillator circuit
- Reset IC ZM33064
- +5V voltage regulator LM78L05
- power supply filtering capacitors
- extension pin headers for each uC pin
- FR-4, 1.5 mm (0,062"), green soldermask, white silkscreen component print
- dimensions 47x47 mm (1.85x1.85")

ELECTROSTATIC WARNING

The AVR-H128-CAN board is shipped in protective anti-static packaging. The board must not be subject to high electrostatic potentials. General practice for working with static sensitive devices should be applied when working with this board.

BOARD USE REQUIREMENTS

Cables: The cable you will need depends on the programmer/debugger you use. If you use AVR-JTAG or AVR-PG1 you will need RS232, if you use AVR-USB-JTAG or AVR-ISP500/TINY/ISO you will need 1.8 m A-B USB cable, if you use AVR-PG2, you will need LPT cable.

Hardware: One of OLIMEX Programmers/Debuggers - [AVR-JTAG](#), [AVR-USB-JTAG](#), [AVR-ISP500](#), [AVR-ISP500-TINY](#), [AVR-ISP500-ISO](#), [AVR-PG1](#), [AVR-PG2](#).

Software: AVR C compiler.

PROCESSOR FEATURES

AVR-H128-CAN board use High-performance, Low-power AVR® 8-bit Microcontroller – AT90CAN128 from Atmel Corporation with these features:

- Advanced RISC Architecture
 - 133 Powerful Instructions – Most Single Clock Cycle Execution
 - 32 x 8 General Purpose Working Registers + Peripheral Control Registers
 - Fully Static Operation
 - Up to 16 MIPS Throughput at 16 MHz
 - On-chip 2-cycle Multiplier
- Non volatile Program and Data Memories
 - 128K Bytes of In-System Reprogrammable Flash
 - Endurance: 10,000 Write/Erase Cycles
 - Optional Boot Code Section with Independent Lock Bits
 - Selectable Boot Size: 1K Bytes, 2K Bytes, 4K Bytes or 8K Bytes
 - In-System Programming by On-Chip Boot Program (CAN, UART, ...)
 - True Read-While-Write Operation
 - 4K Bytes EEPROM (Endurance: 100,000 Write/Erase Cycles)
 - 4K Bytes Internal SRAM
 - Up to 64K Bytes Optional External Memory Space
 - Programming Lock for Software Security
- JTAG (IEEE std. 1149.1 Compliant) Interface
 - Boundary-scan Capabilities According to the JTAG Standard
 - Programming Flash (Hardware ISP), EEPROM, Lock & Fuse Bits
 - Extensive On-chip Debug Support
- CAN Controller 2.0A & 2.0B - ISO 16845 Certified
 - 15 Full Message Objects with Separate Identifier Tags and Masks
 - Transmit, Receive, Automatic Reply and Frame Buffer Receive Modes
 - 1Mbits/s Maximum Transfer Rate at 8 MHz
 - Time stamping, TTC & Listening Mode (Spying or Autobaud)
- Peripheral Features
 - Programmable Watchdog Timer with On-chip Oscillator
 - 8-bit Synchronous Timer/Counter-0
 - 10-bit Prescaler
 - External Event Counter
 - Output Compare or 8-bit PWM Output

- 8-bit Asynchronous Timer/Counter-2
 - 10-bit Prescaler
 - External Event Counter
 - Output Compare or 8-Bit PWM Output
 - 32Khz Oscillator for RTC Operation
- Dual 16-bit Synchronous Timer/Counters-1 & 3
 - 10-bit Prescaler
 - Input Capture with Noise Canceler
 - External Event Counter
 - 3-Output Compare or 16-Bit PWM Output
 - Output Compare Modulation
- 8-channel, 10-bit SAR ADC
 - 8 Single-ended Channels
 - 7 Differential Channels
 - 2 Differential Channels With Programmable Gain at 1x, 10x, or 200x
- On-chip Analog Comparator
- Byte-oriented Two-wire Serial Interface
- Dual Programmable Serial USART
- Master/Slave SPI Serial Interface
 - Programming Flash (Hardware ISP)
- Special Microcontroller Features
 - Power-on Reset and Programmable Brown-out Detection
 - Internal Calibrated RC Oscillator
 - 8 External Interrupt Sources
 - 5 Sleep Modes: Idle, ADC Noise Reduction, Power-save, Power-down & Standby
 - Software Selectable Clock Frequency
 - Global Pull-up Disable
- Operating Voltages: 2.7 - 5.5V
- Operating temperature: Industrial (-40°C to +85°C)
- Maximum Frequency: 8 MHz at 2.7V, 16 MHz at 4.5V
- 53 Programmable I/O Lines

BLOCK DIAGRAM

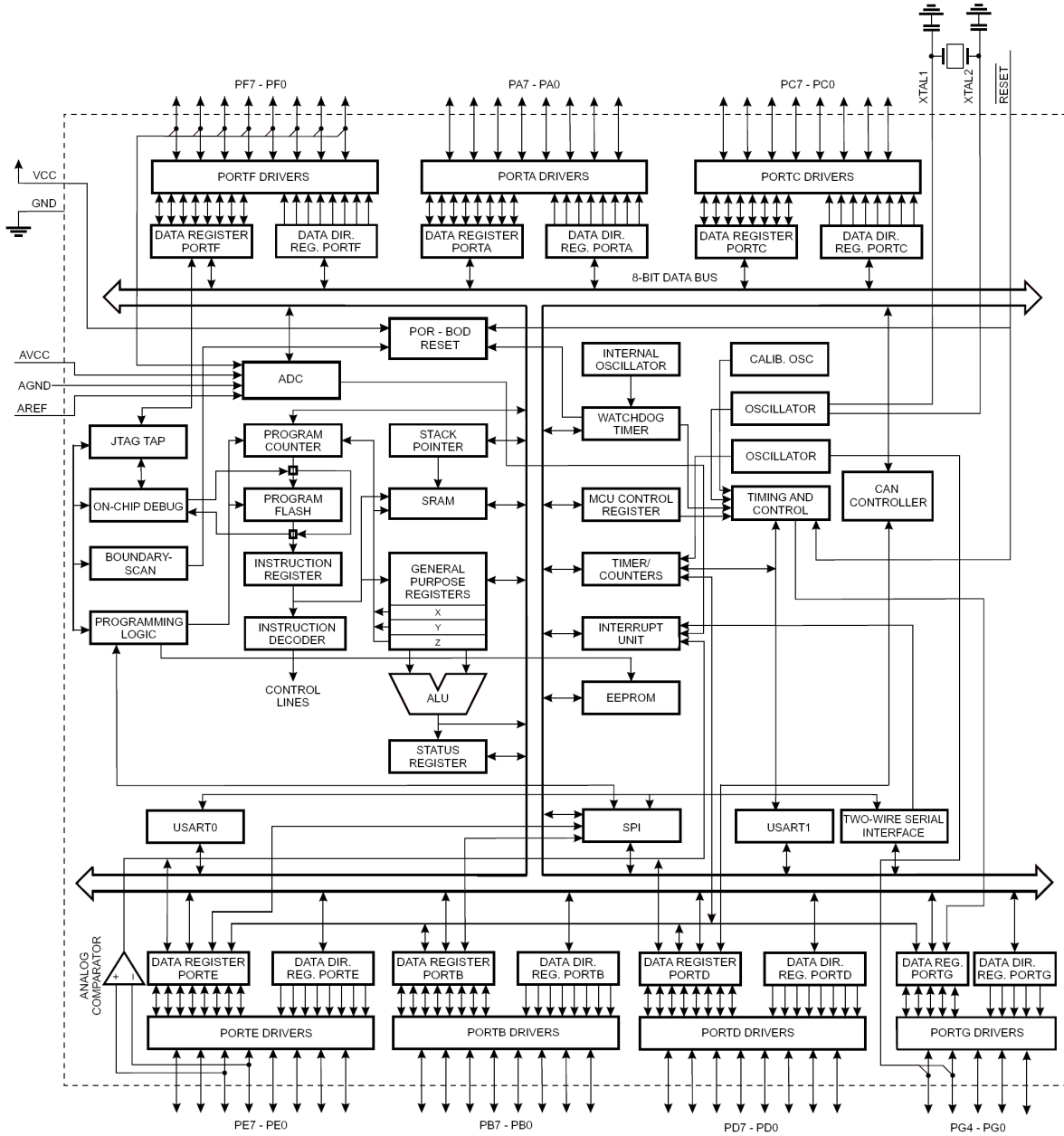

MEMORY MAP:

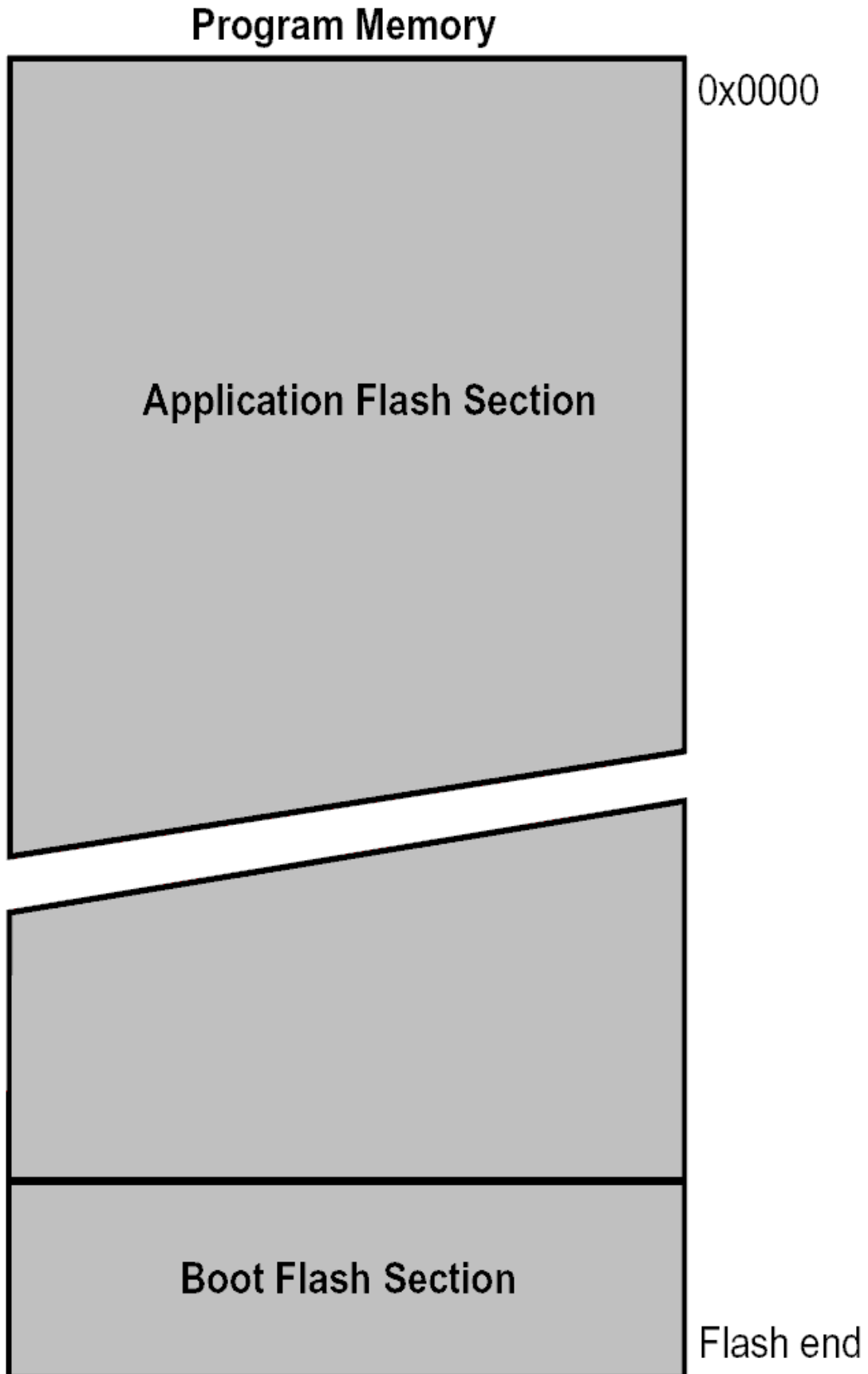

Data Memory Map

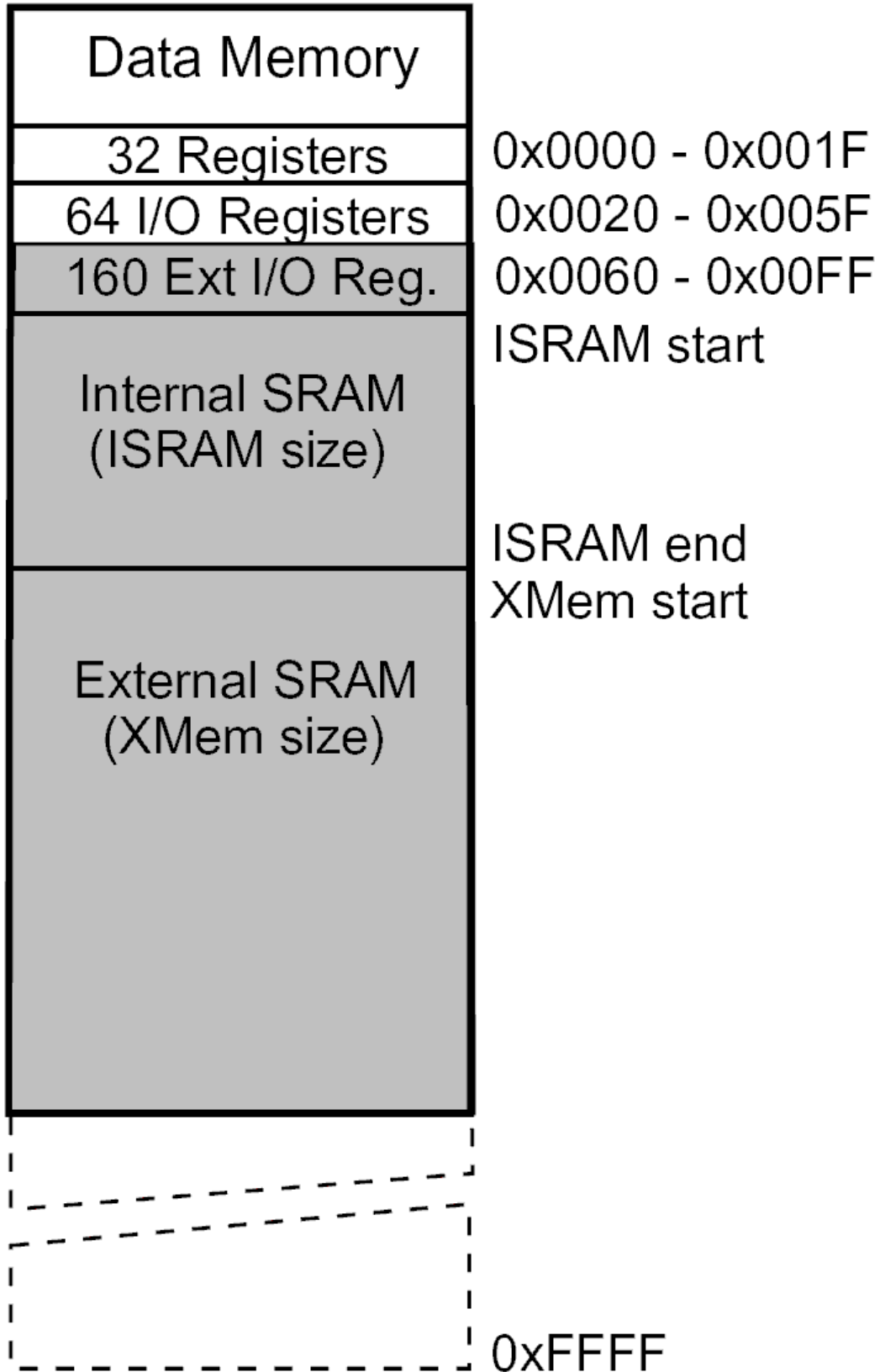

SCHEMATIC

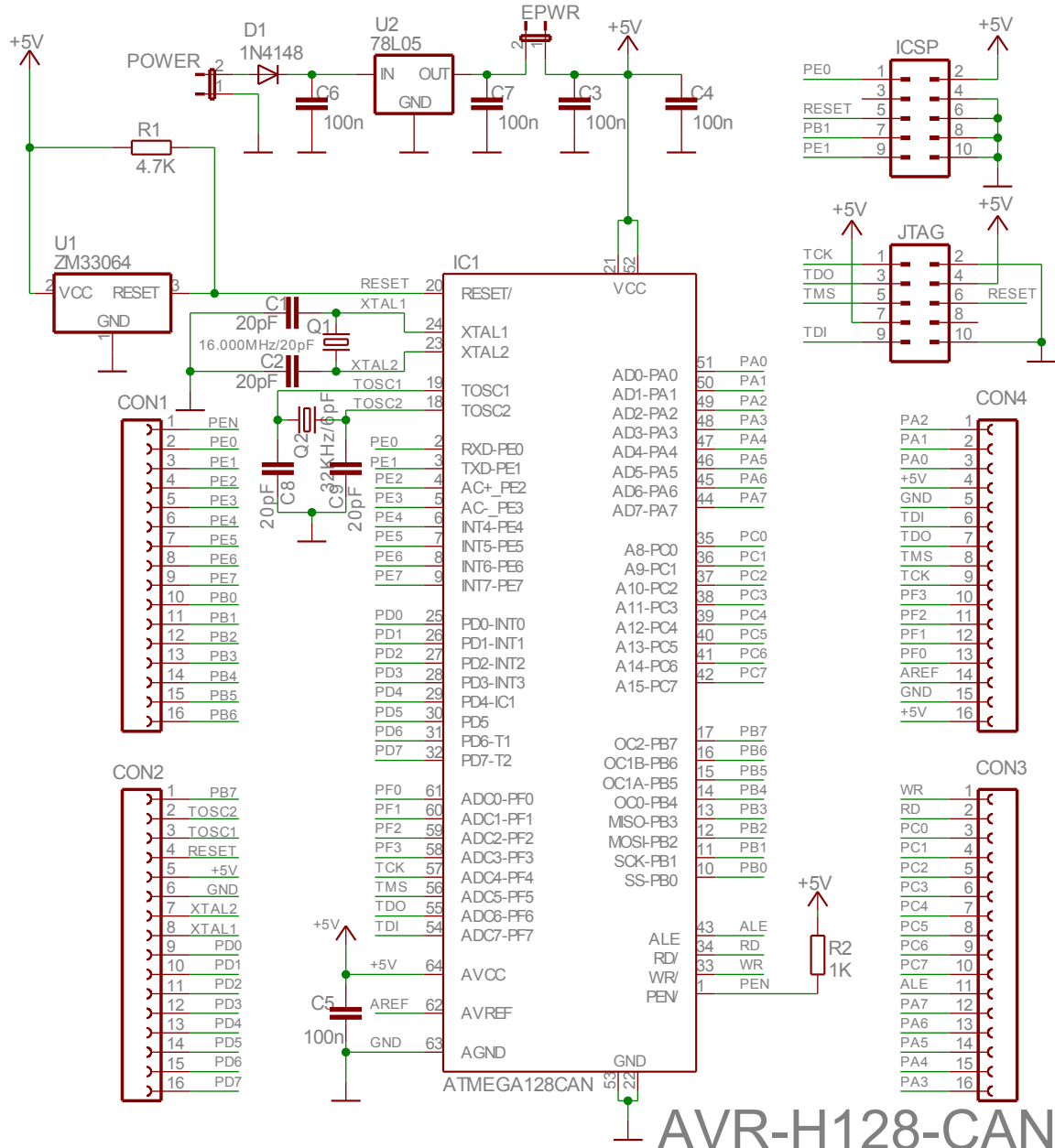

AVR-H128-CAN

Rev. A
COPYRIGHT(C), 2005
<http://www.olimex.com/dev>

BOARD LAYOUT

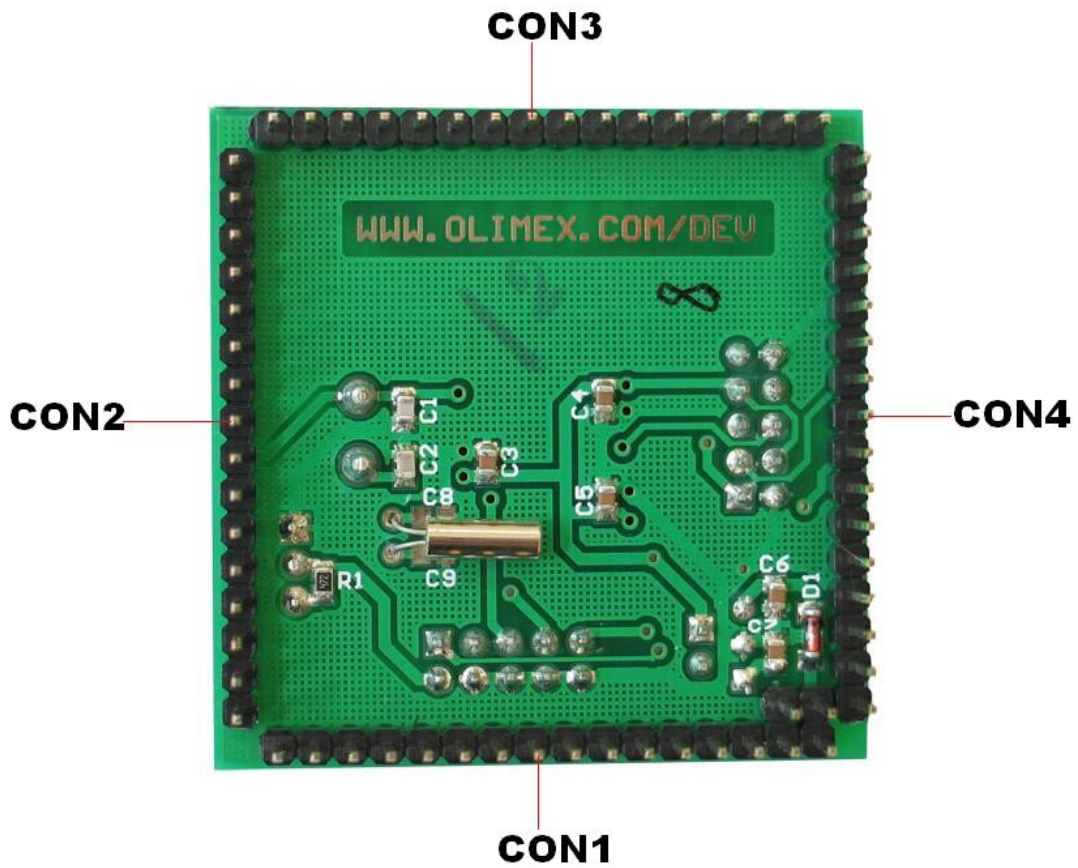
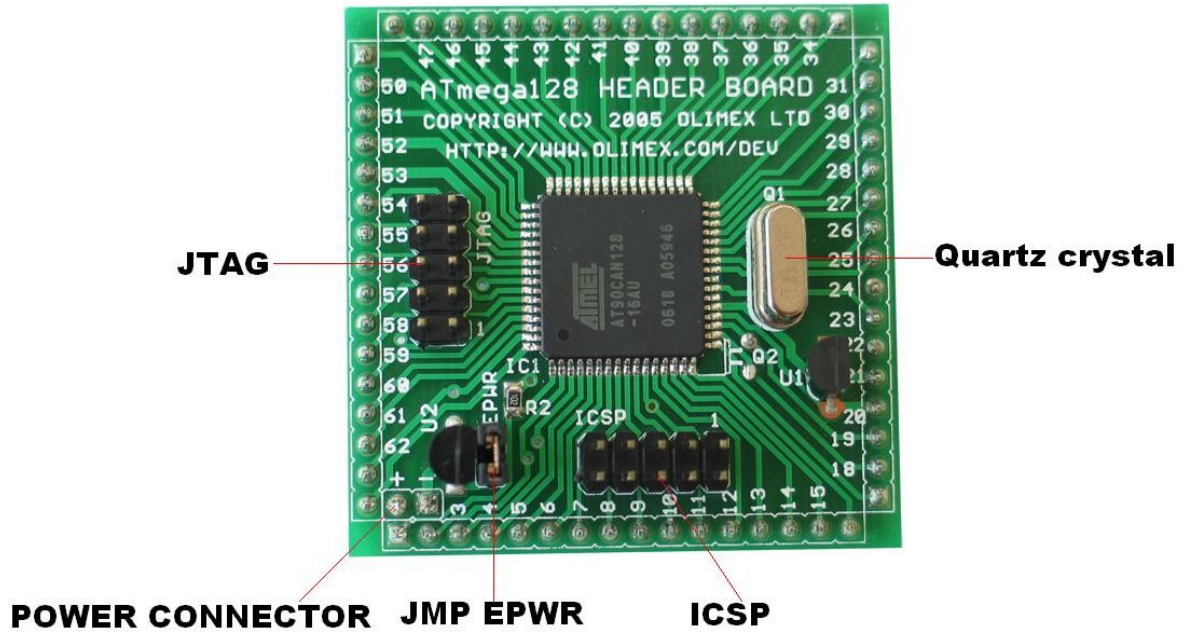

POWER SUPPLY CIRCUIT

The board is power supplied from POWER connector pin 1 and pin 2 with 9-12 V DC.

RESET CIRCUIT

AVR-H128-CAN reset circuit includes pin 6 of JTAG connector, pin 5 of ICSP connector, Extension connector CON2 - pin 4 and AT90CAN128 pin 20.

CLOCK CIRCUIT

Quartz crystal 16MHz is connected to AT90CAN128 pin 23 (XTAL2) and pin 24 (XTAL1).

Quartz crystal 32kHz is connected to AT90CAN128 pin 18 (TOSC2) and pin 19 (TOSC1).

JUMPER DESCRIPTION

EPWR



Enable target power supply.

CONNECTOR DESCRIPTIONS

JTAG

Pin #	Signal Name
1	TCK
2	GND
3	TDO
4	+5V
5	TMS
6	RESET
7	+5V
8	NC
9	TDI
10	GND

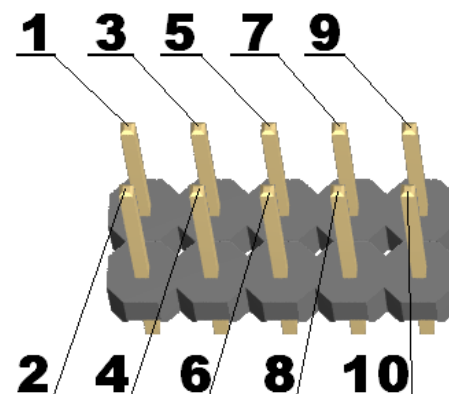

ICSP

Pin #	Signal Name
1	PE0
2	+5V
3	NC
4	GND
5	RESET
6	GND
7	PB1
8	GND
9	PE1
10	GND

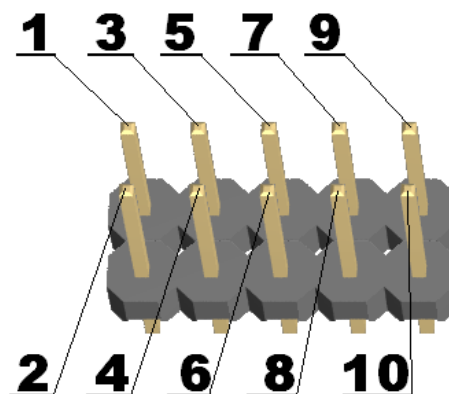

CON1

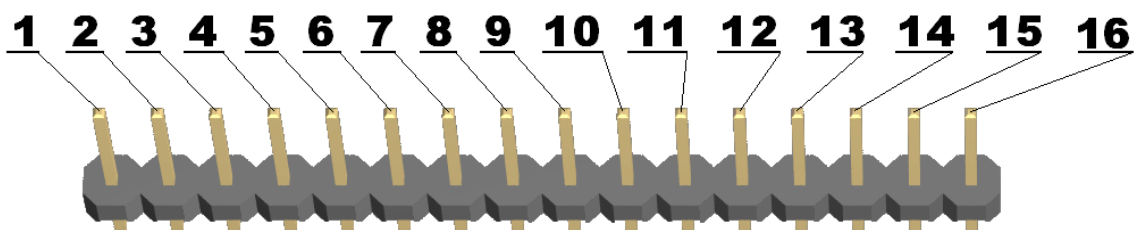

Pin #	Signal Name	Pin #	Signal Name
1	PEN	2	PE0
3	PE1	4	PE2
5	PE3	6	PE4
7	PE5	8	PE6
9	PE7	10	PB0
11	PB1	12	PB2
13	PB3	14	PB4
15	PB5	16	PB6

CON2

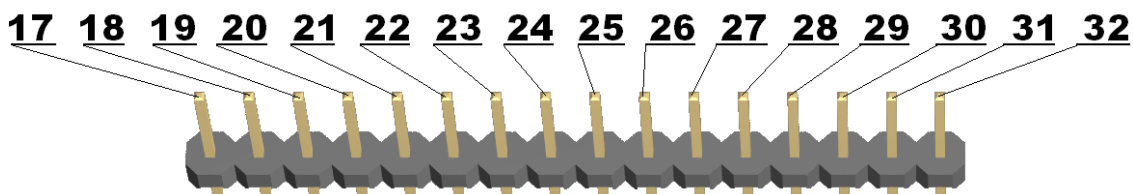

Pin #	Signal Name	Pin #	Signal Name
17	PB7	18	TOSC2
19	TOSC1	20	RESET
21	+5V	22	GND
23	XTAL2	24	XTAL1
25	PD0	26	PD1
27	PD2	28	PD3
29	PD4	30	PD5
31	PD6	32	PD7

CON3

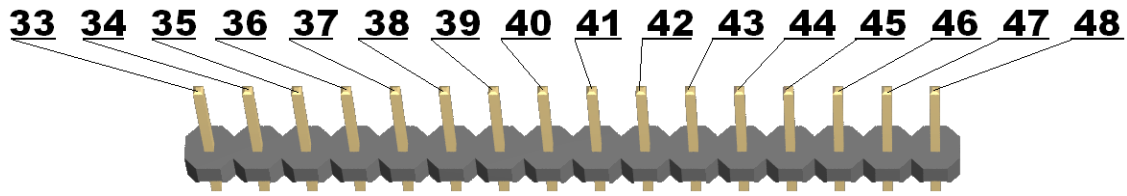

Pin #	Signal Name	Pin #	Signal Name
33	WR	34	RD
35	PC0	36	PC1
37	PC2	38	PC3
39	PC4	40	PC5
41	PC6	42	PC7
43	ALE	44	PA7
45	PA6	46	PA5
47	PA4	48	PA3

CON4

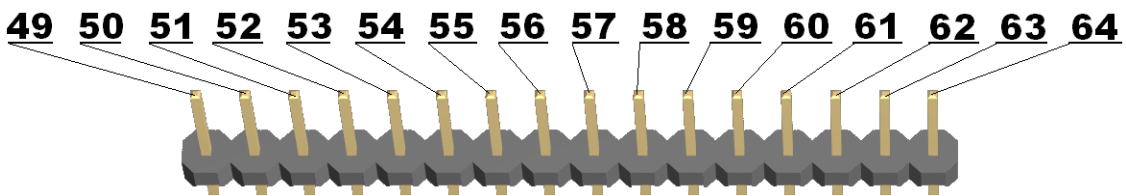

Pin #	Signal Name	Pin #	Signal Name
49	PA2	50	PA1
51	PA0	52	+5V
53	GND	54	TDI
55	TDO	56	TMS
57	TCK	58	PF3
59	PF2	60	PF1
61	PF0	62	AREF
63	GND	64	+5V

POWER CONNECTOR

Pin #	Signal Name
1 (+)	VCC
2 (-)	GND

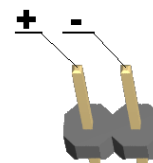

MECHANICAL DIMENSIONS

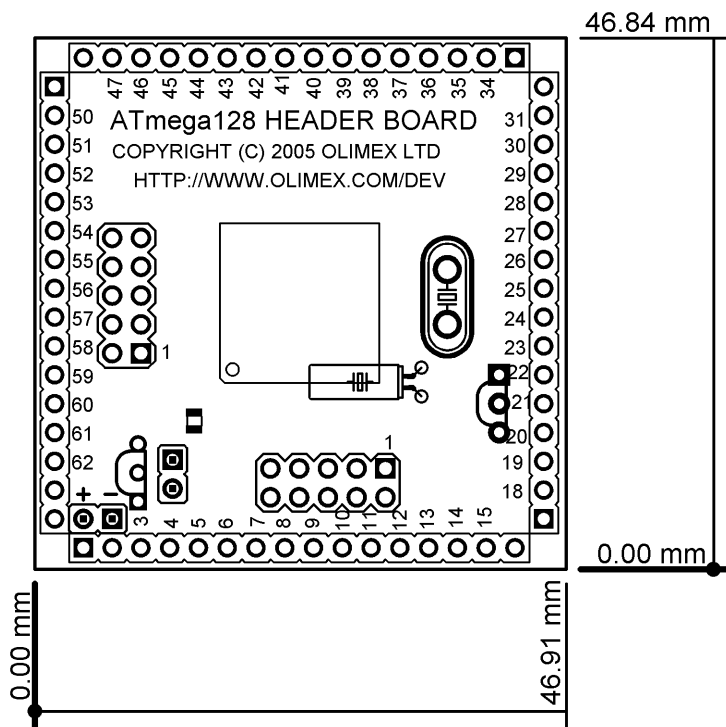

AVAILABLE DEMO SOFTWARE

- Blinking LED C source for WinAVR
- UART initialization C source for WinAVR

ORDER CODE

AVR-H128-CAN - assembled and tested board, includes AT90CAN128-16 microcontroller.

How to order?

You can order to us directly or by any of our distributors.

Check our web www.olimex.com/dev for more info.

Revision history:

REV.A - create January 2005

Disclaimer:

© 2009 Olimex Ltd. All rights reserved. Olimex®, logo and combinations thereof, are registered trademarks of Olimex Ltd. Other terms and product names may be trademarks of others.

The information in this document is provided in connection with Olimex products. No license, express or implied or otherwise, to any intellectual property right is granted by this document or in connection with the sale of Olimex products.

Neither the whole nor any part of the information contained in or the product described in this document may be adapted or reproduced in any material from except with the prior written permission of the copyright holder.

The product described in this document is subject to continuous development and improvements. All particulars of the product and its use contained in this document are given by OLIMEX in good faith. However all warranties implied or expressed including but not limited to implied warranties of merchantability or fitness for purpose are excluded.

This document is intended only to assist the reader in the use of the product. OLIMEX Ltd. shall not be liable for any loss or damage arising from the use of any information in this document or any error or omission in such information or any incorrect use of the product.