

## Excellent Integrated System Limited

Stocking Distributor

Click to view price, real time Inventory, Delivery & Lifecycle Information:

[STMicroelectronics](#)  
[STTH20L03CG-TR](#)

For any questions, you can email us directly:

[sales@integrated-circuit.com](mailto:sales@integrated-circuit.com)



# STTH20L03C

## High frequency secondary rectifier

Datasheet – production data

### Features

- Ultrafast, soft and noise-free recovery
- Low forward voltage drop

### Description

Dual center tap fast recovery epitaxial diodes suited for switch mode power supply and high frequency DC/DC converters.

Packaged in TO-220AB or D<sup>2</sup>PAK, this device is especially intended for secondary rectification inside SMPS with high space and power-density.

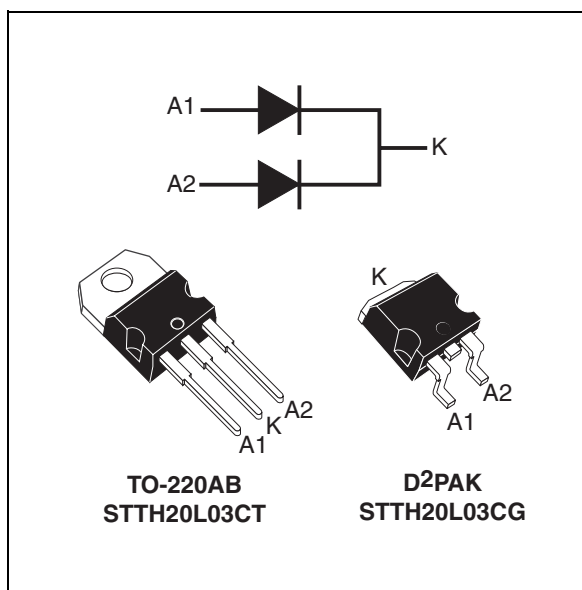

**Table 1. Device summary**

Symbol	Value
$I_{F(AV)}$	2 x 10 A
$V_{RRM}$	300 V
$T_j$	-40 to +175 °C
$V_F(max)$	0.95 V
$t_{rr} (typ)$	26 ns

Characteristics

STTH20L03C

# 1 Characteristics

**Table 2. Absolute ratings (limiting values, per diode, at 25 °C, unless otherwise specified)**

Symbol	Parameter		Value	Unit	
V <sub>RRM</sub>	Repetitive peak reverse voltage		300	V	
I <sub>F(RMS)</sub>	Forward rms current		30	A	
I <sub>F(AV)</sub>	Average forward current, δ = 0.5	T <sub>c</sub> = 155 °C	Per diode	10	A
		T <sub>c</sub> = 150 °C	Per device	20	
I <sub>FSM</sub>	Surge non repetitive forward current	t <sub>p</sub> = 10 ms sinusoidal	150	A	
T <sub>stg</sub>	Storage temperature range		-65 to + 175	°C	
T <sub>j</sub>	Operating junction temperature range		-40 to +175	°C	

**Table 3. Thermal resistance**

Symbol	Parameter		Value (max)	Unit
R <sub>th(j-c)</sub>	Junction to case	Per diode	1.5	°C/W
		Total	1.0	
R <sub>th(c)</sub>	Coupling		0.5	

When diodes 1 and 2 are used simultaneously:

$$T_{j(\text{diode } 1)} = P_{(\text{diode } 1)} \times R_{th(j-c)}(\text{Per diode}) + P_{(\text{diode } 2)} \times R_{th(c)}$$

**Table 4. Static electrical characteristics (per diode)**

Symbol	Parameter	Test conditions		Min.	Typ.	Max.	Unit
I <sub>R</sub> <sup>(1)</sup>	Reverse leakage current	T <sub>j</sub> = 25 °C	V <sub>R</sub> = V <sub>RRM</sub>			10	μA
		T <sub>j</sub> = 125 °C			10	100	
V <sub>F</sub> <sup>(2)</sup>	Forward voltage drop	T <sub>j</sub> = 25 °C	I <sub>F</sub> = 10 A		0.95	1.2	V
		T <sub>j</sub> = 125 °C			0.8	0.95	

1. Pulse test: t<sub>p</sub> = 5 ms, δ < 2%

2. Pulse test: t<sub>p</sub> = 380 μs, δ < 2%

To evaluate the conduction losses use the following equation:

$$P = 0.8 \times I_{F(AV)} + 0.015 I_{F(RMS)}^2$$

**STTH20L03C**

**Characteristics**

**Table 5. Dynamic electrical characteristics (per diode)**

Symbol	Parameter	Test conditions		Min.	Typ.	Max.	Unit
$t_{rr}$	Reverse recovery time	$T_j = 25\text{ }^\circ\text{C}$	$I_F = 1\text{ A}, V_R = 30\text{ V}$ $di_F/dt = -100\text{ A}/\mu\text{s}$		26	35	ns
		$T_j = 125\text{ }^\circ\text{C}$	$I_F = 10\text{ A}, V_R = 200\text{ V}$ $di_F/dt = -200\text{ A}/\mu\text{s}$		55	72	
$I_{RM}$	Reverse recovery current	$T_j = 125\text{ }^\circ\text{C}$	$I_F = 10\text{ A}, V_R = 200\text{ V}$ $di_F/dt = -200\text{ A}/\mu\text{s}$		9	12	A
$S_{factor}$	Softness factor				0.3		
$Q_{RR}$	Reverse recovery charges	$T_j = 125\text{ }^\circ\text{C}$	$I_F = 10\text{ A}, V_R = 200\text{ V}$ $di_F/dt = -200\text{ A}/\mu\text{s}$		250	375	nC
$t_{fr}$	Forward recovery time	$T_j = 25\text{ }^\circ\text{C}$	$I_F = 10\text{ A}, V_{FR} = 1.05\text{ V}$ $di_F/dt = 100\text{ A}/\mu\text{s}$			200	ns
$V_{FP}$	Forward recovery voltage				2.5	3.5	V

**Figure 1. Conduction losses versus average forward current (per diode)**

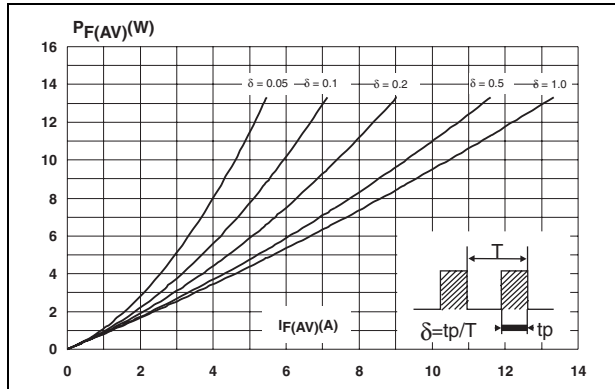

**Figure 2. Forward voltage drop versus forward current (per diode)**

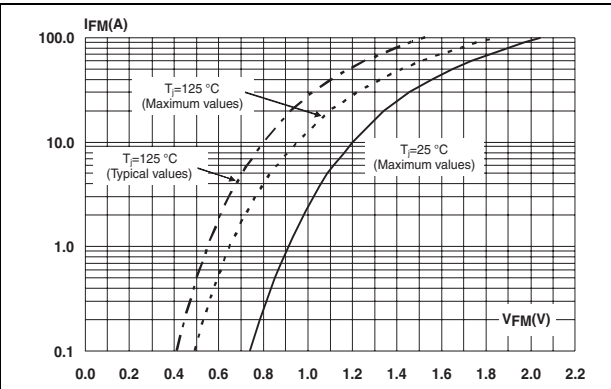

**Figure 3. Relative variation of thermal impedance junction to case versus pulse duration**

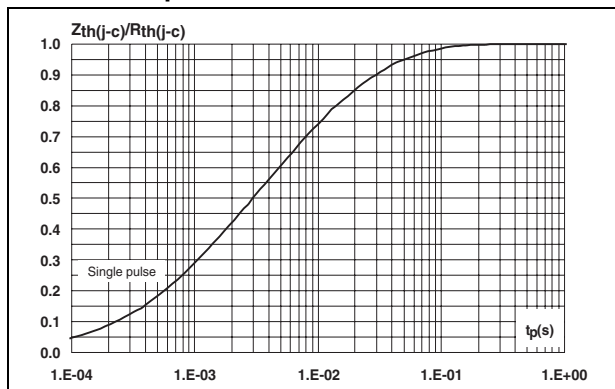

**Figure 4. Peak reverse recovery current versus di/dt (typical values, per diode)**

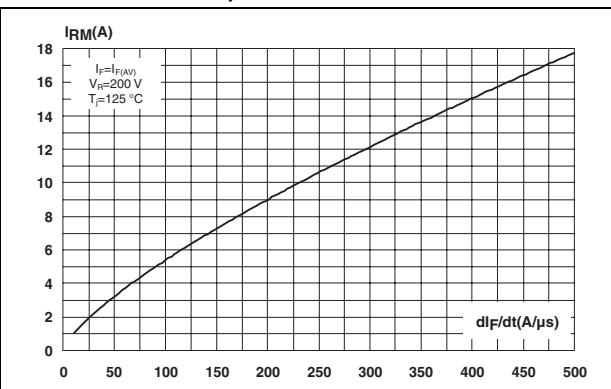

Characteristics

STTH20L03C

Figure 5. Reverse recovery time versus  $di_F/dt$  (typical values, per diode)

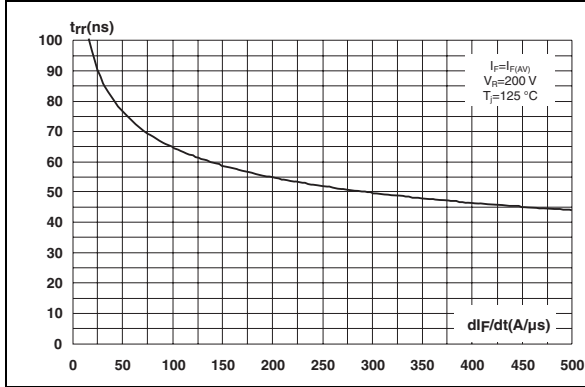

Figure 6. Reverse recovery charge versus  $di_F/dt$  (typical values, per diode)

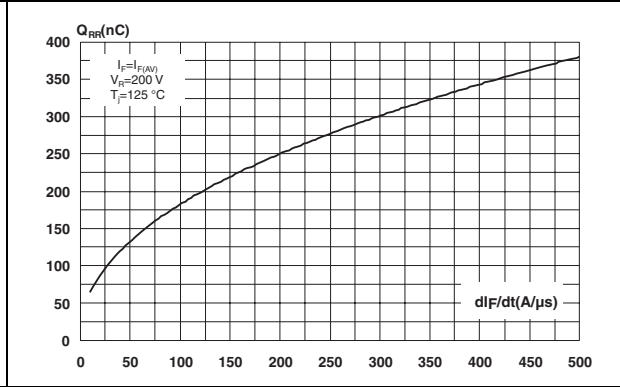

Figure 7. Reverse recovery softness factor versus  $di_F/dt$  (typical values, per diode)

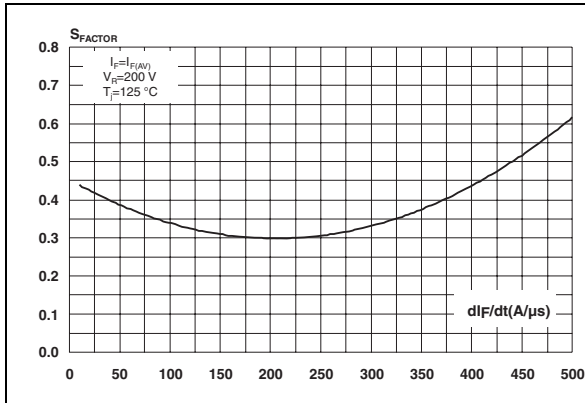

Figure 8. Relative variation of dynamic parameters versus junction temperature

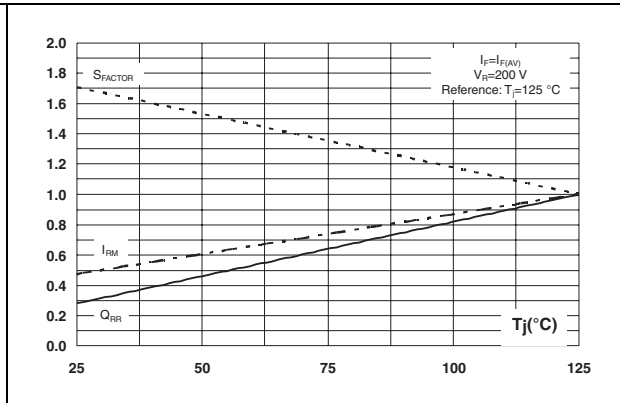

Figure 9. Transient peak forward voltage versus  $di_F/dt$  (typical values, per diode)

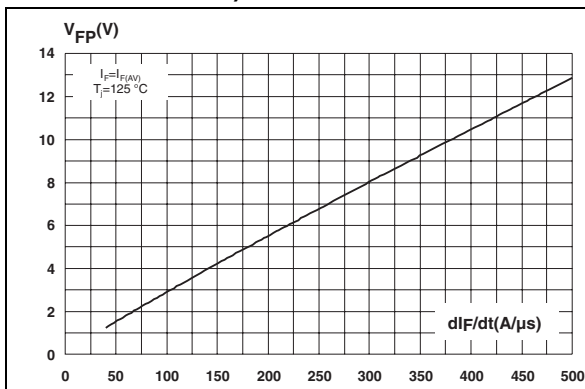
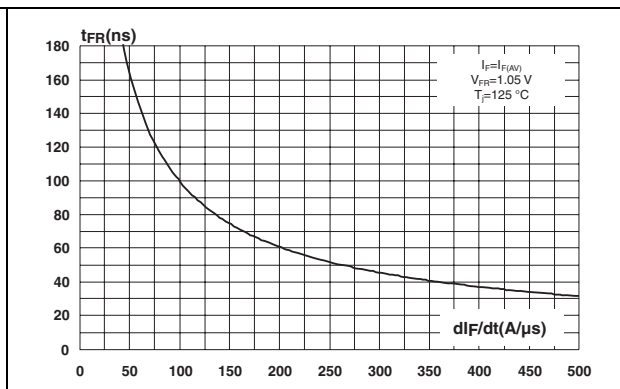

Figure 10. Forward recovery time versus  $di_F/dt$  (typical values, per diode)



**STTH20L03C**

**Characteristics**

**Figure 11. Junction capacitance versus reverse voltage applied (typical values, per diode)**

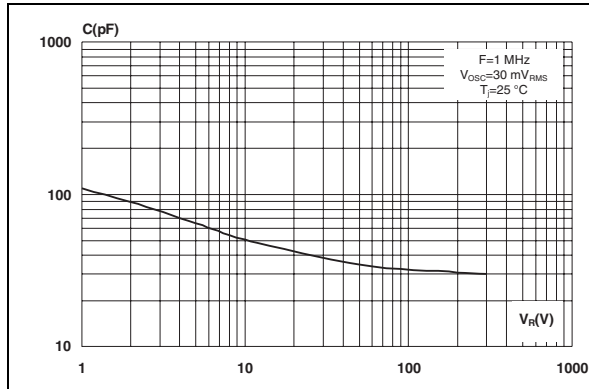

**Figure 12. Thermal resistance, junction to ambient, versus copper surface under tab (D<sup>2</sup>PAK)**

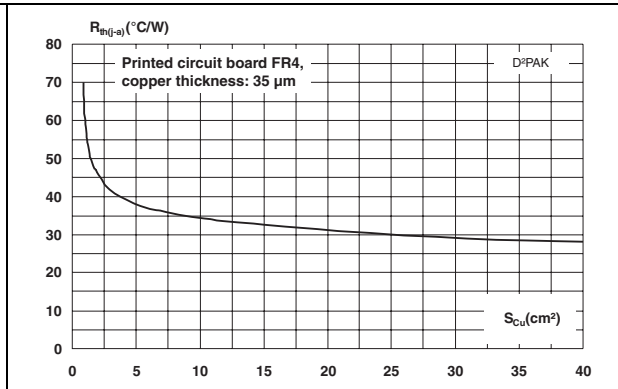

## 2 Package information

- Epoxy meets UL94, V0
- Cooling method: by conduction (C)
- Recommended torque value: 0.4 to 0.6 N·m

In order to meet environmental requirements, ST offers these devices in different grades of ECOPACK<sup>®</sup> packages, depending on their level of environmental compliance. ECOPACK<sup>®</sup> specifications, grade definitions and product status are available at: [www.st.com](http://www.st.com). ECOPACK<sup>®</sup> is an ST trademark.

Table 6. D<sup>2</sup>PAK dimensions

Ref.	Dimensions			
	Millimeters		Inches	
	Min.	Max.	Min.	Max.
A	4.40	4.60	0.173	0.181
A1	2.49	2.69	0.098	0.106
A2	0.03	0.23	0.001	0.009
B	0.70	0.93	0.027	0.037
B2	1.14	1.70	0.045	0.067
C	0.45	0.60	0.017	0.024
C2	1.23	1.36	0.048	0.054
D	8.95	9.35	0.352	0.368
E	10.00	10.40	0.393	0.409
G	4.88	5.28	0.192	0.208
L	15.00	15.85	0.590	0.624
L2	1.27	1.40	0.050	0.055
L3	1.40	1.75	0.055	0.069
M	2.40	3.20	0.094	0.126
R	0.40 typ.		0.016 typ.	
V2	0°	8°	0°	8°

Figure 13. Footprint (dimensions in mm)

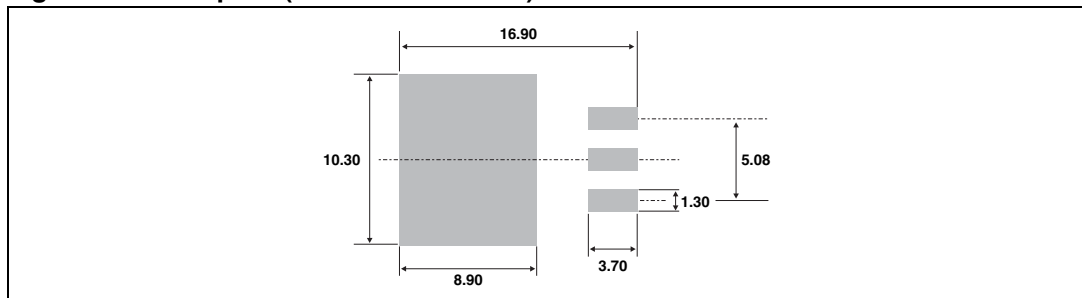

**STTH20L03C**

**Package information**

**Table 7. TO-220AB dimensions**

Ref.	Dimensions			
	Millimeters		Inches	
	Min.	Max.	Min.	Max.
A	4.40	4.60	0.173	0.181
C	1.23	1.32	0.048	0.051
D	2.40	2.72	0.094	0.107
E	0.49	0.70	0.019	0.027
F	0.61	0.88	0.024	0.034
F1	1.14	1.70	0.044	0.066
F2	1.14	1.70	0.044	0.066
G	4.95	5.15	0.194	0.202
G1	2.40	2.70	0.094	0.106
H2	10	10.40	0.393	0.409
L2	16.4 typ.		0.645 typ.	
L4	13	14	0.511	0.551
L5	2.65	2.95	0.104	0.116
L6	15.25	15.75	0.600	0.620
L7	6.20	6.60	0.244	0.259
L9	3.50	3.93	0.137	0.154
M	2.6 typ.		0.102 typ.	
Diam.	3.75	3.85	0.147	0.151

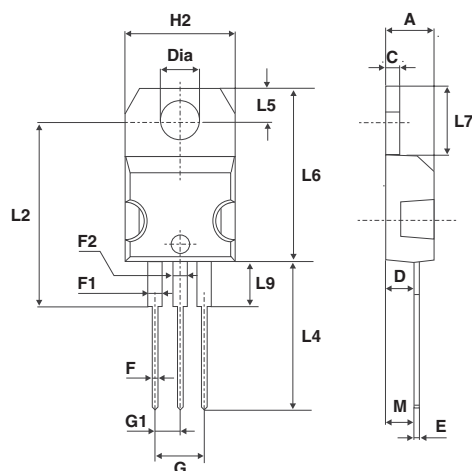



Ordering information

STTH20L03C

### 3 Ordering information

Table 8. Ordering information

Order code	Marking	Package	Weight	Base qty	Delivery mode
STTH20L03CT	STTH20L03CT	TO-220AB	1.9 g	50	Tube
STTH20L03CG-TR	STTH20L03CG	D <sup>2</sup> PAK	1.48 g	1000	Tape and reel

### 4 Revision history

Table 9. Document revision history

Date	Revision	Changes
22-Jun-2012	1	Initial release.

## STTH20L03C

---

### Please Read Carefully:

Information in this document is provided solely in connection with ST products. STMicroelectronics NV and its subsidiaries ("ST") reserve the right to make changes, corrections, modifications or improvements, to this document, and the products and services described herein at any time, without notice.

All ST products are sold pursuant to ST's terms and conditions of sale.

Purchasers are solely responsible for the choice, selection and use of the ST products and services described herein, and ST assumes no liability whatsoever relating to the choice, selection or use of the ST products and services described herein.

No license, express or implied, by estoppel or otherwise, to any intellectual property rights is granted under this document. If any part of this document refers to any third party products or services it shall not be deemed a license grant by ST for the use of such third party products or services, or any intellectual property contained therein or considered as a warranty covering the use in any manner whatsoever of such third party products or services or any intellectual property contained therein.

**UNLESS OTHERWISE SET FORTH IN ST'S TERMS AND CONDITIONS OF SALE ST DISCLAIMS ANY EXPRESS OR IMPLIED WARRANTY WITH RESPECT TO THE USE AND/OR SALE OF ST PRODUCTS INCLUDING WITHOUT LIMITATION IMPLIED WARRANTIES OF MERCHANTABILITY, FITNESS FOR A PARTICULAR PURPOSE (AND THEIR EQUIVALENTS UNDER THE LAWS OF ANY JURISDICTION), OR INFRINGEMENT OF ANY PATENT, COPYRIGHT OR OTHER INTELLECTUAL PROPERTY RIGHT.**

**UNLESS EXPRESSLY APPROVED IN WRITING BY TWO AUTHORIZED ST REPRESENTATIVES, ST PRODUCTS ARE NOT RECOMMENDED, AUTHORIZED OR WARRANTED FOR USE IN MILITARY, AIR CRAFT, SPACE, LIFE SAVING, OR LIFE SUSTAINING APPLICATIONS, NOR IN PRODUCTS OR SYSTEMS WHERE FAILURE OR MALFUNCTION MAY RESULT IN PERSONAL INJURY, DEATH, OR SEVERE PROPERTY OR ENVIRONMENTAL DAMAGE. ST PRODUCTS WHICH ARE NOT SPECIFIED AS "AUTOMOTIVE GRADE" MAY ONLY BE USED IN AUTOMOTIVE APPLICATIONS AT USER'S OWN RISK.**

Resale of ST products with provisions different from the statements and/or technical features set forth in this document shall immediately void any warranty granted by ST for the ST product or service described herein and shall not create or extend in any manner whatsoever, any liability of ST.

ST and the ST logo are trademarks or registered trademarks of ST in various countries.

Information in this document supersedes and replaces all information previously supplied.

The ST logo is a registered trademark of STMicroelectronics. All other names are the property of their respective owners.

© 2012 STMicroelectronics - All rights reserved

STMicroelectronics group of companies

Australia - Belgium - Brazil - Canada - China - Czech Republic - Finland - France - Germany - Hong Kong - India - Israel - Italy - Japan - Malaysia - Malta - Morocco - Philippines - Singapore - Spain - Sweden - Switzerland - United Kingdom - United States of America

[www.st.com](http://www.st.com)