

Excellent Integrated System Limited

Stocking Distributor

Click to view price, real time Inventory, Delivery & Lifecycle Information:

[Bel Fuse Inc.](#)
[HKS48T30120-PCA0](#)

For any questions, you can email us directly:
sales@integrated-circuit.com

HKS48T30120 DC-DC Series Data Sheet

Half-Brick with 48VDC Input; 12VDC @ 32A Output



Applications

- Power systems utilizing IBA (Intermediate Bus Architecture)
- Networking equipment
- Data/voice processing
- Wireless communications
- Computing

Benefits

- Simplifies power system design; reduces design time and technical risk
- Compatible with all (12 Vin nom) POLs available in the market

Features

- RoHS lead free solder and lead solder exempted products are available
- Fully regulated output
- High output power of 384 W
- Flat efficiency curve to 94.5%
- Wide-input voltage range from 35 to 75 VDC
- 100V/100ms input voltage surge withstand
- Backdrive protection
- Start-up into pre-biased load
- Output overcurrent protection
- Output overvoltage protection
- Overtemperature protection
- Remote on/off (primary referenced), positive or negative logic option
- Designed to comply with NEBS GR-1089 and GR-63
- Basic insulation
- Input-to-output isolation: 2121 VDC
- Safety: UL60950-1, CSA C22.2 No. 60950-1-03, TUV EN60950-1:2001, IEC60950-1:2001

Description

The HKS is a high density and highly efficient, isolated DC-DC converter that operates over an input voltage range of 35 to 75 VDC. It provides a 12 VDC nominal, fully regulated output at up to 32 Amperes of direct current. The converter is an ideal choice for building a complete power system utilizing the Intermediate Bus Architecture (IBA). The thermally-optimized construction of the HKS allows the unit to provide high output current over a wide operating temperature range while maintaining a safe guardband for electrical and thermal component ratings. The HKS employs 100% surface-mount components for consistency and reliability in the production process.

Model Selection

Model	Input Voltage VDC	Input Current, Max ADC ¹	Output Voltage VDC	Output Rated Current I _{rated} ADC	Output Ripple/Noise, mV _{P-P} ²	Typical Eff. @ I _{rated} %
HKS48T30120	35-75	12	12 (NOM.)	32	120 (NOM.)	94.5

¹ @ V_{IN} min.

² (DC to 500 kHz)



HKS48T30120 DC-DC Series Data Sheet Half-Brick with 48VDC Input; 12VDC @ 32A Output

Absolute Maximum Ratings

Stresses in excess of the absolute maximum ratings may cause performance degradation, adversely effect long-term reliability, and cause permanent damage to the converter.

Parameter	Conditions/Description	Min	Max	Units
Input voltage	Continuous		75	VDC
	Transient withstand		100	VDC
Operating Temperature	Hot Spot Monitor Location ²	-40	124	°C
	Ambient	-40	85	°C
Storage Temperature		-55	125	°C
ON/OFF Control Voltage	Referenced to -Vin	-1	18	VDC
Output Power ¹			384	W

¹ with appropriate power derating, see figure 17.

² See temperature probe locations Figure 18, 19.

Environmental and Mechanical Specifications

Parameter	Conditions/Description	Min	Nom	Max	Units
Operating Humidity	Relative Humidity, Non-cond.			95	%
Storage Humidity	Relative Humidity, Non-cond.			95	%
Water Washing	Standard process	Yes			
Shock	Halfsine wave, 3 axes	50			G
Sinusoidal Vibration	GR-63-CORE, Section 5.4.2	1			G
Weight			2.9 (82)		Oz(g)
Dimensions	(Overall)	2.28 (57.9) x 2.4 (61.0) x 0.5 (12.7)			In. (mm)
MTBF (Calculated)	Per Telcordia SR-332 Issue 1, (method 1, case 2, GB, 40°C)	1.2			MHrs

Isolation Specifications

All specifications apply over specified input voltage, output load, and temperature range, unless otherwise noted.

Parameter	Conditions/Description	Min	Nom	Max	Units
Insulation Safety Rating		Basic			
Isolation Voltage	Input to Output	2121			VDC
	Input to Baseplate	N/A			
	Output to Baseplate	N/A			
Isolation Resistance	Input to Output	10			MΩ
Capacitance	Input to Output		1,000		pF



HKS48T30120 DC-DC Series Data Sheet Half-Brick with 48VDC Input; 12VDC @ 32A Output

EMI & Safety Regulatory Compliance

Safety Agency	Standard Approved To:	Marking
UL	UL60950-1 / CSA C22.2 No. 60950-1-03	cURus
TUV product service	TUV EN60950-1:2001	TUV PS Baurt mark
CB report	IEC60950-1:2001	N/A
Declaration of Conformity	DIR 73/23/EEC Low Voltage Directive	CE
Conducted Emissions ¹	(with external EMI filter)	CISPR 22 class A

¹ See figures 20 & 21.

Input Specifications

All specifications apply over the specified input voltage and output load at @ 40 °C ambient temperature, unless otherwise noted.

Parameter	Conditions/Description	Min	Nom	Max	Units
Input Voltage	Continuous	35	48	75	VDC
Maximum Input Current	Vin =35V, Iout=I _{RATED}			12	ADC
Turn-On Input Voltage (UVLO) ¹	Ramping Up	32.5	33.5	34.6	VDC
Turn-Off Input Voltage ¹	Ramping Down	30.1	31.5	32.8	VDC
Turn-Off Hysteresis		1.5			VDC
Input Reflected Ripple Current	I _{RATED} , 12µH source inductance BW=20MHz ²		15	50	mA _{p-p}
No-load Input Current	35VDC ≤ Vin ≤ 75VDCc		170	250	mA
No-load Power Dissipation	Vin = 48VDC			8	W
Disabled Input Current	35VDC ≤ Vin ≤ 75VDC		21	24	mA
Inrush Transient	Vin=Vin.max			2	A ² s

¹ See figure 2

² Vin = 48 V, see Figures 1 & 10.

Output Specifications

All specifications apply over specified input voltage, output load, and @ 40 °C ambient temperature, unless otherwise noted.

Parameter	Conditions/Description	Min	Nom	Max	Units
Output Voltage Set-point	(Vin = 48 V, Io = 30 A)	11.7	12	12.3	VDC
Line Regulation:	(Vi = 35 V to 75 V, Io _{RATED})		< 0.03	0.06	VDC
			< 0.25	0.5	% Vo
Load Regulation:	(Vin = 48 V, Io = 0 to 30 A)		< 0.06	0.12	VDC
			< 0.5	1.0	% Vo
Temperature Regulation	(T _{AMBIENT}) = -40 °C to +85 °C)		0.005	0.03	%/°C
Total Error Band	(Line, Load, Temperature, Ripple, Life)	11.5	12	12.5	VDC
Dynamic Regulation ¹	75-100-75% load step change, to 1% error band, Co=220µF				
Peak Deviation	di/dt = 1.0A/µs >>>		+/-525	+/-725	mV
Settling Time			100	175	µs
Peak Deviation	di/dt = 0.1A/µs >>>		+/-400	+/-550	mV
Settling Time			100	175	µs

¹ See Figure 7.

HKS48T30120 DC-DC Series Data Sheet Half-Brick with 48VDC Input; 12VDC @ 32A Output



General Specifications

All specifications apply over specified input voltage, output load, and @ 40°C ambient temperature, unless otherwise noted.

Parameter	Conditions/Description	Min	Nom	Max	Units
Output Current	I_{rated}	0		32	ADC
Current Derating ¹	@ 200LFM, 55°C _{AMBIENT}			23	ADC
	@ 200LFM, 70°C _{AMBIENT}			20.2	ADC
Efficiency ² (T _{AMB} =40°C)	V _{IN} NOM, I _O = I _{RATED}		94.5		%
Operating (output ripple) Frequency	Fixed frequency		260		kHz
Output Ripple ³	Over line and load, T _{AMB} = 0°C to 85°C (DC to 20MHz)		150	300	mVp-p
			1.25	2.5	% Vo
			50	100	mV _{RMS}
Turn-on Overshoot ⁴	Overall input voltage, load, and temperature conditions		0	0	%Vout
Turn-On Time ⁴ (via application of input voltage)	Time from Vin=UVLO to regulation band		20	100	ms
Turn-On Time ⁴ (via On/Off signal)	Time from enable to regulation band		16	100	ms
Rise Time ⁴	From 10 to 90% of Vout _{NOM}		16	30	ms
Admissible Load Capacitance		220		14,000 ⁵	μF

¹ See Figure 17.

² See Figure 3.

³ See Figures 8 & 9.

⁴ See Figure 4, 5 & 6.

⁵ 10/90% mix of ceramic / low ESR tantalum capacitors or OS-CON

Protections Specifications

All specifications apply over specified input voltage, output load, and @ 40 °C ambient temperature, unless otherwise noted.

Parameter	Conditions/Description	Min	Nom	Max	Units
Overcurrent Protection					
Type	Non-latching – auto-recovery, hiccup type.				
Threshold	V _{in} = V _{in} NOM	33		40	ADC
Short Circuit ¹	Hiccup Mode		13.5	18	A _{RMS}
Overvoltage Protection					
Type	Latching, recycle input voltage or ON/OFF signal to unlatch				
Threshold ²	V _{in} = V _{in} NOM, I _{out} = I _{RATED}	14.15	14.6	15.25	VDC
Overtemperature Protection					
Type	Non-latching, auto-recovery				
Threshold	PCB temperature	120		130	°C
Hysteresis			10		°C

¹ Refer to Figure 11.

² Refer to Figure 12 & 13.



HKS48T30120 DC-DC Series Data Sheet Half-Brick with 48VDC Input; 12VDC @ 32A Output

Feature Specifications

All specifications apply over specified input voltage, output load, and @ 40°C ambient temperature, unless otherwise noted.

Parameter	Conditions/Description	Min	Nom	Max	Units
On/Off					
Negative Logic (-N suffix)	(On/Off signal is low – converter is ON)				
On/Off (pin 3) (Primary side ref. to -Vin)	Converter ON Sink current	-0.5		0.8 0.5	VDC mADC
	Converter OFF Open circuit voltage	2.5	4.8	18 5	VDC VDC
Positive Logic (-P suffix)	(On/Off signal is low – converter is OFF)				
On/Off (pin 3) (Primary side ref. to -Vin)	Converter ON Open Circuit Voltage	2.5	4.8	18 5	VDC VDC
	Converter OFF Sink Current	-0.5		0.8 0.5	VDC mADC
Remote Sense ¹					
Remote Sense Headroom				1.2	VDC
Output Voltage Trim ¹					
Trim Up				1.2	VDC
Trim Down		-1.2			VDC

¹ Combined output voltage positive adjustment cannot exceed 1.2 VDC (also refer to "Output Voltage Adjust" section)



HKS48T30120 DC-DC Series Data Sheet
Half-Brick with 48VDC Input; 12VDC @ 32A Output

Performance Characteristics

Reflected Ripple Current

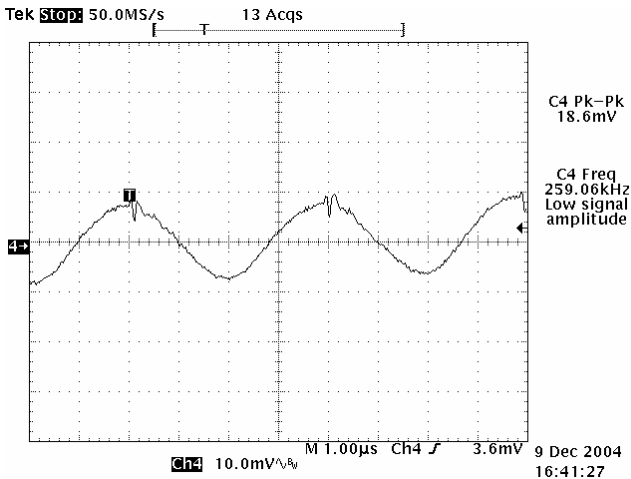

Figure 1. Input Reflected Ripple Current (typ)

Conditions: Output current = 32 ADC.
 Input voltage = 48 VDC.
 Channel 1 - Input_{RRC} < 8mA_{P-P} (measured)
 Scale : 5mA/10mV or 5mA/division.

UVLO (Undervoltage lockout)

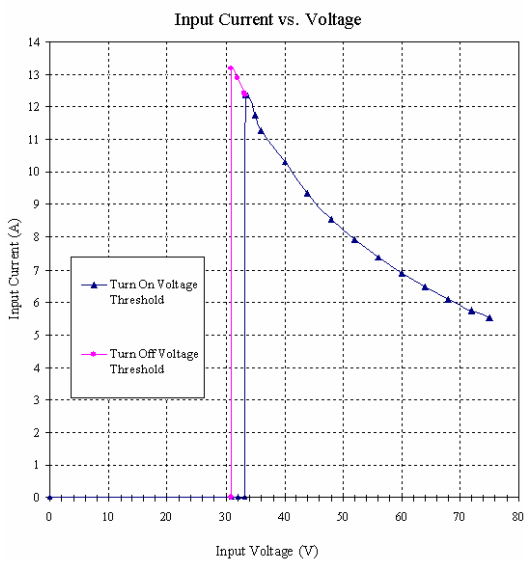

Figure 2. Undervoltage Lockout Characteristics (typ)

Efficiency

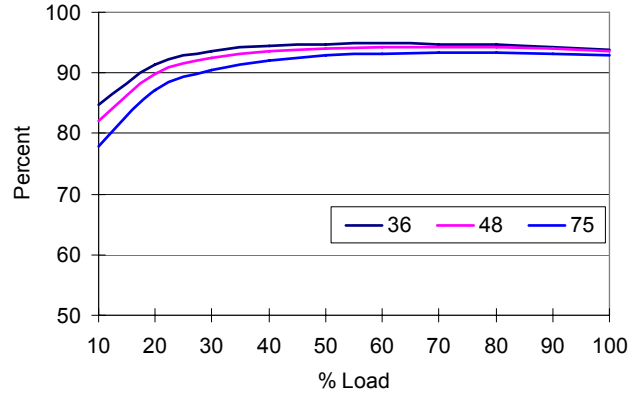

Figure 3. Efficiency Characteristics (typ)

Vo Turn-on Characteristics (as a function of Vin)

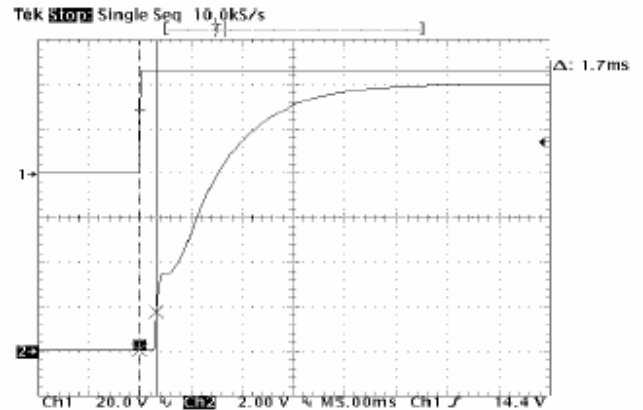

Figure 4. Turn-On Characteristics @ Power-up (typ)

Conditions: Vin nominal, Cext = 220 µF
 Output current: 32 ADC
 Channel 1 - Input voltage: 48 VDC
 Scale : 20V/div.
 Channel 2 - Output voltage
 Time base = 5ms/div.

The output voltage begins to rise approximately 1 to 2 msec after the input voltage reaches the turn-on threshold of the input undervoltage protection circuit.



HKS48T30120 DC-DC Series Data Sheet
Half-Brick with 48VDC Input; 12VDC @ 32A Output

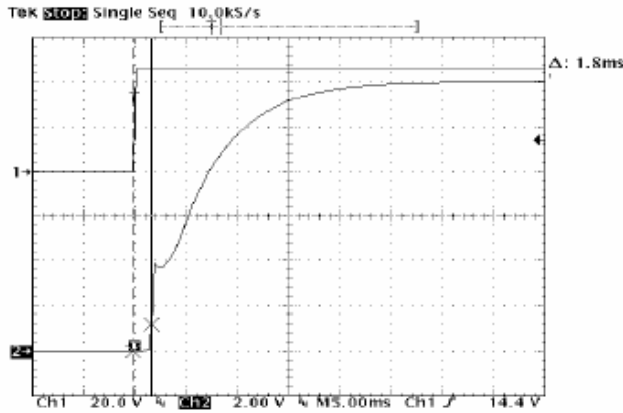

Figure 5. Turn-On Characteristics @ Power-up (typ)

Conditions: V_{in} max., $C_{ext} = 220\mu F$
 Output current: 0 ADC
 Channel 1 - Input voltage: 48 VDC
 Scale : 20V/div., 5ms/div.
 Channel 2 - Output voltage
 Time base = 5ms/div.

V_o Turn-on Characteristics (as a function of On/Off)

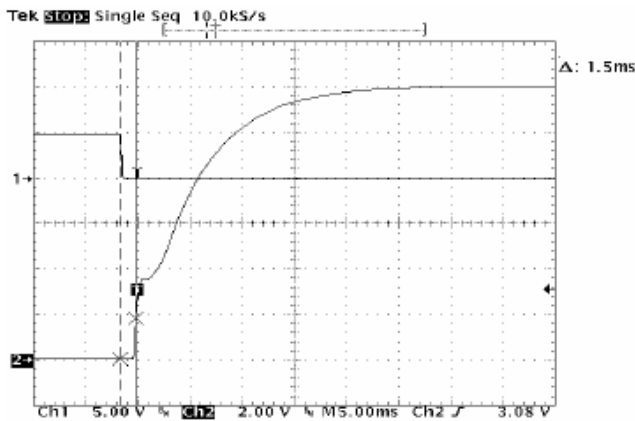

Figure 6. Turn-On Characteristics via On/Off Ctrl (typ)

(Negative logic On/Off shown)

Conditions: V_{in} nominal, $C_{ext} = 220\mu F$
 Output current: 32 ADC
 Channel 1 - On/Off signal
 Scale : 5V/div.
 Channel 2 - Output voltage
 Amplitude = 2V/div.
 Time base = 5ms/div.

The output voltage begins to rise approximately 1 to 2 ms after the converter is enabled by the ON/OFF signal.

Dynamic Response

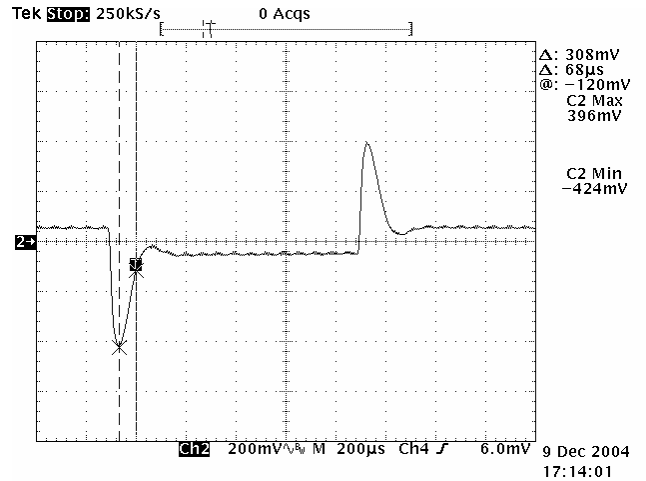

Figure 7. Dynamic Load Response (typ)

Conditions: V_{in} nominal, $C_{ext} = 220\mu F$
 The load is switched from 16 A to 24 A
 (25% load Δ) with a slew rate of $di/dt = 1.0A/\mu s$
 Channel 1 - Voltage deviation: $\sim \pm 400mV$ (measured)
 Scale : 200mV/div, 200µs/div.

Output Ripple and Noise

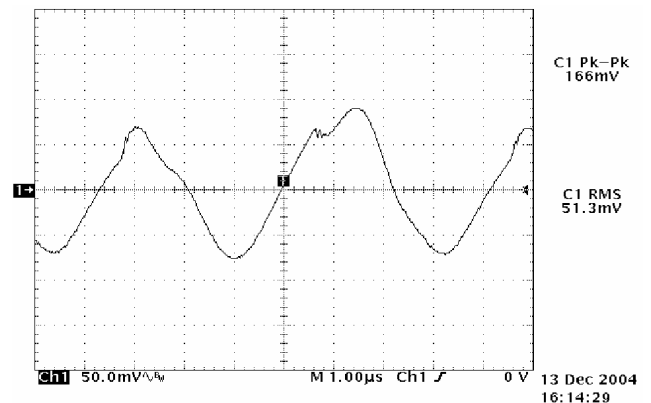

Figure 8. Output Ripple & Noise (typ)

Conditions: $V_{in} = 48V$ and $I_{out} = 32A$.
 Channel 1 - V_o , (AC coupled), $166mV_{P-P}$ or $51mV_{RMS}$
 Scale : 50mV/div.



HKS48T30120 DC-DC Series Data Sheet
Half-Brick with 48VDC Input; 12VDC @ 32A Output

Noise Measurement Methods

To improve the accuracy and repeatability of ripple and noise measurements, Power-One utilizes the test setups shown in Figure 9 & 10 below.

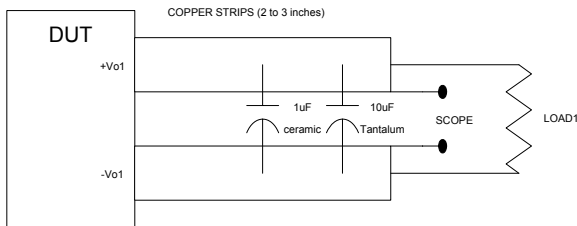

Figure 9. Output Ripple and Noise Measurement Test Setup

A BNC connector is used for measurements to eliminate noise pickup associated with long ground leads of conventional scope probes. The connector, a 0.1 µF ceramic, a 10 µF tantalum capacitor, and the load are located 2-3” away from the converter.

For output decoupling, we recommend using a 10µF low ESR tantalum (AVX TPSC106M025R0500 is used in Power-One test setup) and a 0.1µF ceramic capacitor. Note that the capacitors do not substitute for filtering required by the load.

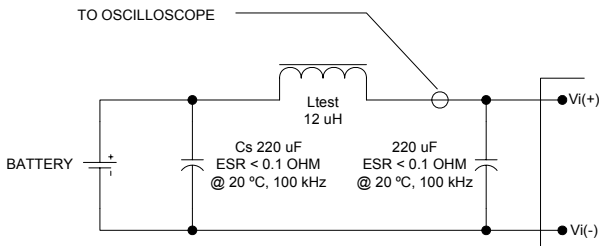

Figure 10. Input Reflected Ripple Current Measurement Setup

Note: Measure input reflected-ripple current with a simulated inductance (Ltest) of 12 µH. Capacitors offset possible battery impedance. Measure current as shown above

Overcurrent Protection

To provide protection from an output overload or short circuit condition, the HKS is equipped with current limiting circuitry and can endure the fault condition for an unlimited duration. At the point of current-limit inception, the converter enters hiccup mode, causing the output current to be limited in both peak and duration. While in the hiccup mode, the converter attempts to restart approximately once every 150 ms as shown in Figure 11. Because of very low duty cycle the RMS value of output current is limited to only 8 A_{RMS} max..

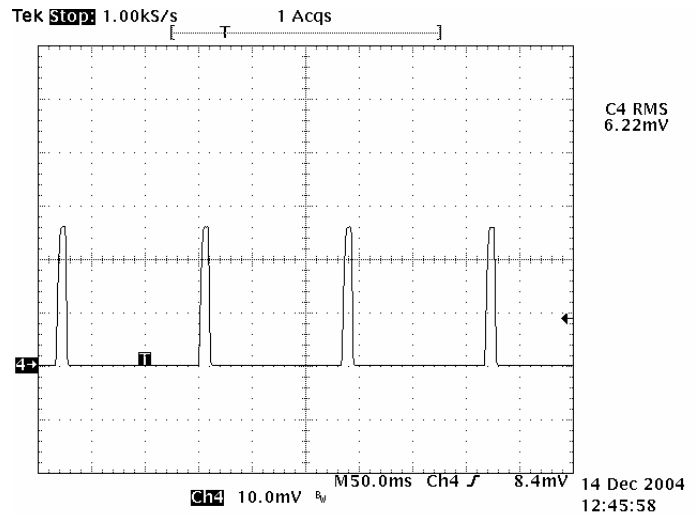

Figure 11. Short Circuit Behavior (typ)

Condition: Vin = 75 VDC

Channel 1 - Short circuit current, 6.22A_{RMS} (measured)

Scale: 20 Amperes/division.

Once the output current is brought back into its specified range, the converter automatically exits the hiccup mode and continues normal operation.

Back Driving

The HKS DC-DC converter uses a control driven synchronous rectification technique. Applying an external voltage on the output of a unit that is shut down will not cause damage.



HKS48T30120 DC-DC Series Data Sheet
Half-Brick with 48VDC Input; 12VDC @ 32A Output

Overvoltage Protection

The output overvoltage protection consists of a separate control loop, independent of the primary control loop. This secondary control loop has a higher voltage set point than the primary loop. In a fault condition, the converter limits its output voltage and latches off. This action ensures the output voltage does not exceed $V_{OVP\ max}$. Figure 12 & 13 show operation of the converter during an induced overvoltage condition.

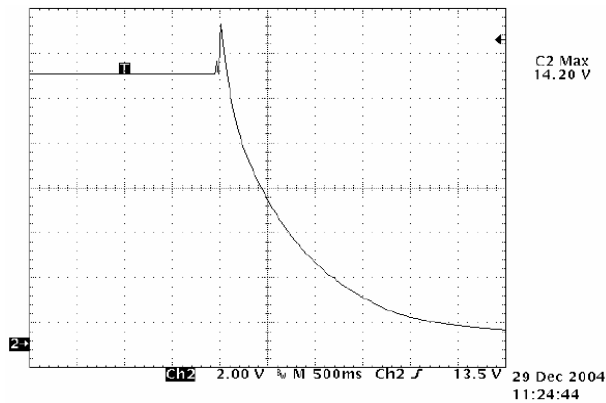

Figure 12. Induced OVP Behavior (typ)

(Unit A.)
 Conditions: $V_{in} = 75\ V$ and $I_{out} = 0\ A$ (no-load).
 Induced, fast V_o increase
 Channel 1- $V_{OVP} = 14.2\ VDC$ (Trip voltage measured),
 Scale : 2V/div.

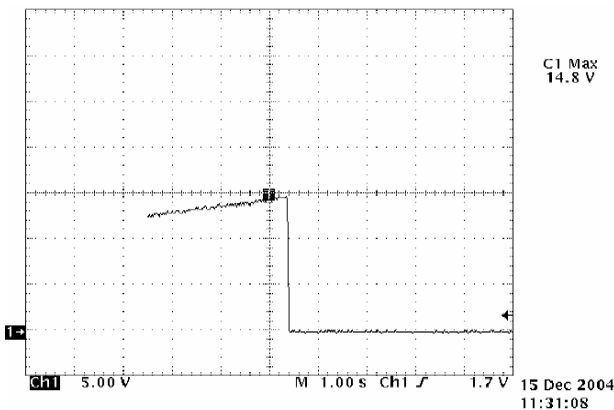

Figure 13. Induced OVP Behavior (typ).

(Unit B.)
 Conditions: $V_{in} = 75\ V$ and $I_{out} = 75\%$ load.
 Induced, gradual V_o increase
 Channel 1- $V_{OVP} = 14.8\ VDC$ (Trip voltage, measured),
 Scale : 5V/div.

Features Description

ON/OFF Control (ref. figure 16)

-Pxxx suffix model

With the positive logic model, when the ON/OFF pin is pulled low, the output is turned off and the unit draws less than 4mA of input current. If the ON/OFF pin is not used, it can be left floating.

-Nxxx suffix model

With negative logic, when the ON/OFF pin is pulled low, the unit is turned on. If the ON/OFF pin is not used, it can be connected to the -Vin pin.

(Common to -Pxxx & -Nxxx versions)

The ON/OFF pin is pulled up internally, so no external voltage source is required or recommended. The ON/OFF pin is internally referenced to the -Vin pin. An open collector switch is recommended to control the voltage between these two points

The controlling signal must not be referenced ahead of EMI filtering, or remotely from the unit. Optically coupling the control signal and locating the opto-coupler directly, is recommended for trouble-free operation.



HKS48T30120 DC-DC Series Data Sheet
Half-Brick with 48VDC Input; 12VDC @ 32A Output

Output Voltage Adjustment

The trim feature allows the user to adjust the output voltage from its nominal value.

The HKS trims up with a resistor from the Trim (# 7) pin to the +Sense (# 8) pin and trims down with a resistor from the Trim pin to the -Sense (# 6) pin as shown in the Figure 15.

The equations below determine the trim resistor value required to achieve a ΔV change in the output voltage.

$$R_{adj-up} = \left(\frac{Vo(100 + \Delta\%)}{1.225\Delta\%} - \frac{(100 + 2\Delta\%)}{\Delta\%} \right) k\Omega$$

$$R_{adj-down} = \left(\frac{100}{\Delta\%} - 2 \right) k\Omega$$

Where ΔV% is the output voltage change expressed in percent of the nominal output voltage, Vo.
 (For example the maximum allowable percent change increase is 10; [i.e., 1.2 V = 10%.])

Output Voltage Trim Values

R(KOhm)	Vo Up	R(KOhm)	Vo Down
887.39	12.12	98.00	11.88
447.59	12.24	48.00	11.76
300.99	12.36	31.33	11.64
227.69	12.48	23.00	11.52
183.71	12.6	18.00	11.4
154.39	12.72	14.67	11.28
133.45	12.84	12.29	11.16
117.74	12.96	10.50	11.04
105.53	13.08	9.11	10.92
95.76	13.2	8.00	10.8

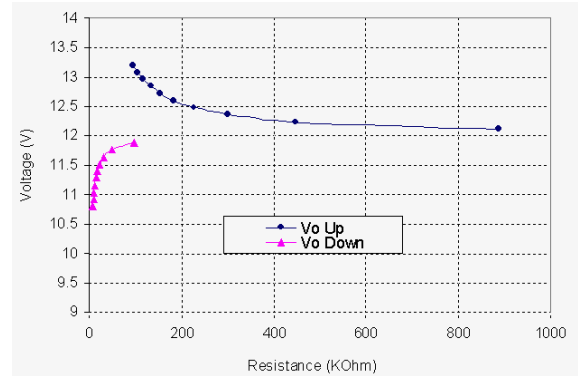

Figure 14. Trim Value Characteristic.

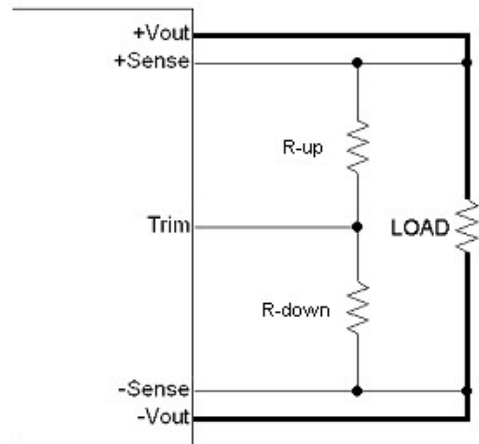

Figure 15. Converter Trim Schematic

Notes:

1. When the output voltage is trimmed up, the output power from the converter must not exceed its maximum rating. The power is determined by measuring the output voltage on the output pins, and multiplying it by the output current.
2. In order to avoid creating apparent load regulation degradation, it is important that the trim resistors be connected directly to the remote sense pins, and not to the load or to traces going to the load.
3. The output voltage increase can be accomplished either by the trim or by the remote sense or by the combination of both. In any case, the absolute maximum output voltage increase shall not exceed the limits defined in the *Features Specification* section above.
4. Either Rup or Rdown should be used to adjust the output voltage according to the equations above. If both Rup and Rdown are used simultaneously, they will form a resistive divider and the equations above will not apply.

HKS48T30120 DC-DC Series Data Sheet

Half-Brick with 48VDC Input; 12VDC @ 32A Output



Application Information

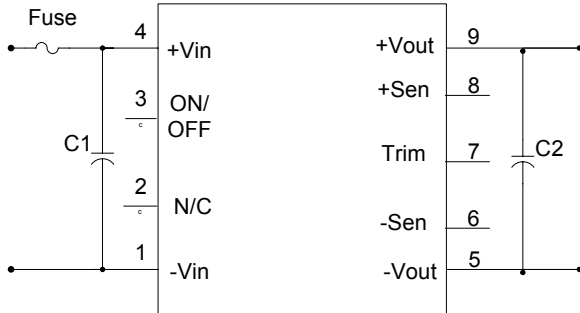

Figure 16. Recommended Connections for the HKS Converter

It is strongly advisable to install external capacitors at the input (C1) and output (C2) of the HKS converter as shown above. These should be of suitably high quality and rated for effective use at low temperatures as needed. If the distribution of the input voltage to the converter contains significant inductance, additional capacitance at C1 may be required to guarantee full performance.

Ref. Des	Minimum recommendations
C1	100 μ F, ESR < 100 mOhms ¹
C2	220 μ F, 35 < ESR < 70 mOhms ¹

¹ Tantalum, aluminum electrolytic or (OS-CON) aluminum semiconductor electrolyte types appropriately rated to the required operating voltage and temperature.

Inrush Current

Refer to the "Inrush Current Control Application Note" (http://www.power-one.com/technical/articles/dc-dc_1-app.pdf) for suggestions on how to limit the magnitude of the inrush current.

Thermal Considerations

HKS converters are designed for both natural and forced convection cooling. To achieve long term reliability, the recommended power derating curves below, were established by comparing measured junction and hot spot temperatures against those allowed per Power-One's component derating guidelines

The graph in Figure 17 shows the maximum recommended output current of the HKS converter at various ambient temperatures under both natural and forced convection (longitudinal airflow direction, from pin 1 to pin 4). Vin = 48 VDC.

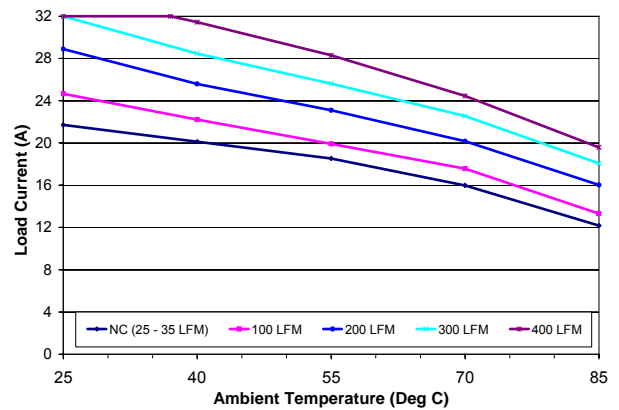

Figure 17. HKS Power Derating Curves

Example, from above, HKS operating at 70°C can deliver up to 20.5Amps reliably with 200LFM of forced air applied.

Thermal Measurements

Measurements requiring airflow were made in Power-One's vertical wind tunnel equipment using both Infrared (IR) thermography as well as the traditional thermocouple method.

With the converter installed into the host application, customer verification that all components are at or below their safe operating temperatures may be performed similarly. However, for a more simplified testing method, monitoring the converter's designated thermal reference point(s) will yield effective results.

Refer to Figure 18 & 19 for recommended location of the measuring thermocouple. This reference point should be maintained at $\leq 124^{\circ}$ C.



HKS48T30120 DC-DC Series Data Sheet
Half-Brick with 48VDC Input; 12VDC @ 32A Output

It is recommended to use 32 AWG to 40 AWG thermocouple wire probes in either most accessible location as identified below (Q21, Q10)

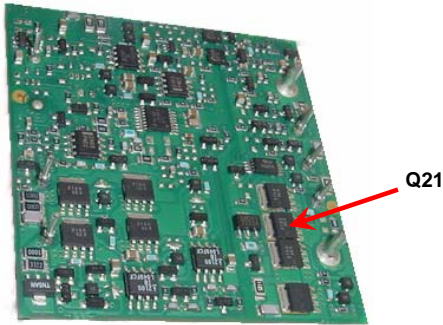

Figure 18. Thermal Reference Q21 (I/O pin side)



Figure 19. Thermal Reference Q10 (Top side)

Conducted EMI

The following line filter configuration and component values are offered as a guideline to assist in designing an effective filter solution in the application.

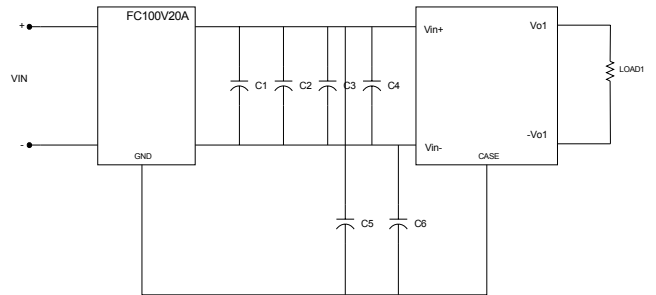

Figure 20. Input filter Configuration Suggested to Meet (CISPR-22) NE55022 Class A Conducted Emission Limits

Input filter components are shown in the table below, and the results of conducted EMI scan are shown in Figure 21.

Part List for the Input Filter

Ref. Des	Description	Manufacturer
C1, C2	0.47µF @100 V MLC Capacitor (1812)	AVX or Equivalent
C3	220 µF @ 100 V Alum. Electrolytic Capacitor	Nichicon NRSZ Series or Equiv.
C4	22 µF@ 100 V Alum. Electrolytic Capacitor	United Chemicon KMG Series or Equiv.
C5, 6	0.01 µF MLC Capacitor	AVX or Equiv.
F1	FC100V20A Input Filter Module	Power-One

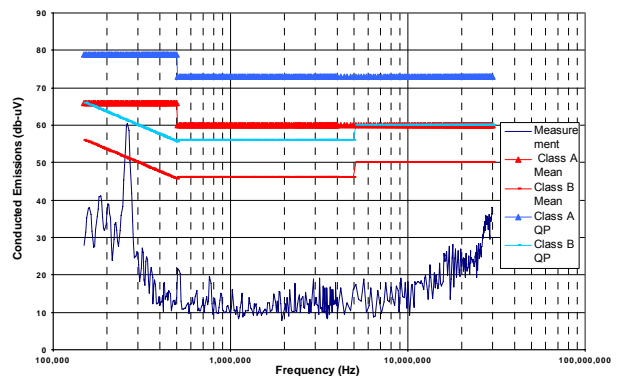

Figure 21. Conducted EMI Scan of the HKS with the Input Filter Configuration Shown in Figure Above.

HKS48T30120 DC-DC Series Data Sheet

Half-Brick with 48VDC Input; 12VDC @ 32A Output



Safety Considerations

The HKS converters feature 1500 VDC isolation from the input-to-output. The input-to-output resistance is greater than 10MΩ. These converters are provided with Basic insulation between input and output circuits according to all IEC60950 based standards. Nevertheless, if the system using the converter needs to receive safety agency approval, certain rules must be followed in the design of the system. In particular, all of the creepage and clearance requirements of the end-use safety requirements must be observed. These documents include UL60950 - CSA60950-00 and EN60950, although other or additional requirements may be needed for specific applications.

The HKS converters have no internal fuse. **The external fuse must be provided to protect the system from catastrophic failure.** Refer to the "Input Fuse Selection for DC/DC converters" application note on www.power-one.com for proper selection of the input fuse. Both input traces and the chassis ground trace (if applicable) must be capable of conducting a current of 1.5 times the value of the fuse without opening. The fuse must not be placed in the grounded input line, if any.

In order for the output of the HKS converter to be considered as SELV (Safety Extra Low Voltage) or TNV-1, according to all IEC60950 based standards, one of the following requirements must be met in the system design:

- If the voltage source feeding the module is SELV or TNV-2, the output of the converter may be grounded or ungrounded.
- If the voltage source feeding the module is ELV, the output of the converter may be considered SELV only if the output is grounded per the requirements of the standard.
- If the voltage source feeding the module is a Hazardous Voltage Secondary Circuit, the voltage source feeding the module must be provided with at least Basic insulation between the source to the converter and any hazardous voltages. The entire system, including the HKS converter, must pass a dielectric withstand test for Reinforced insulation. Design of this type of system requires expert engineering and understanding of the overall safety requirements, and should be performed by qualified personnel.

Converter Part Numbering Ordering Information

Series	# Out	Vin nom.	I/O type	Io (Approx.)	Vo (nom. X 10)	-	On/Off logic	Height	Pin length	Special options
HK	S	48	T	30	120	-	P, N	C	A, B, C	0
½-Brick,	Single output	35 – 75 VDC	Thru-hole	ADC	VDC		See table below			

Features & Options:	Descriptions:	Suffix code:
Remote ON/OFF	Positive logic	-Pxxx
	Negative logic	-Nxxx
Unit Height	0.50" nom. (fixed value, no alternative height)	-xCxx
Pin Length	0.18" (standard model length)	-xxAx
	0.145"	-xxBx
	0.110"	-xxCx
Special Options	None (standard model, no special options)	-xxx0
	Customer-specific models	-xxxS#

RoHS	Add to Part Number
RoHS lead solder exemption	No RoHS character required.
RoHS compliant for all six substances	Add "G" as the last character of the part number.

HKS48T30120 DC-DC Series Data Sheet Half-Brick with 48VDC Input; 12VDC @ 32A Output



Example:

Standard HKS with negative logic, 0.145 pin length; and RoHS lead solder exemption; the resulting part number is HKS48T3012-NCB0

Mechanical Drawing

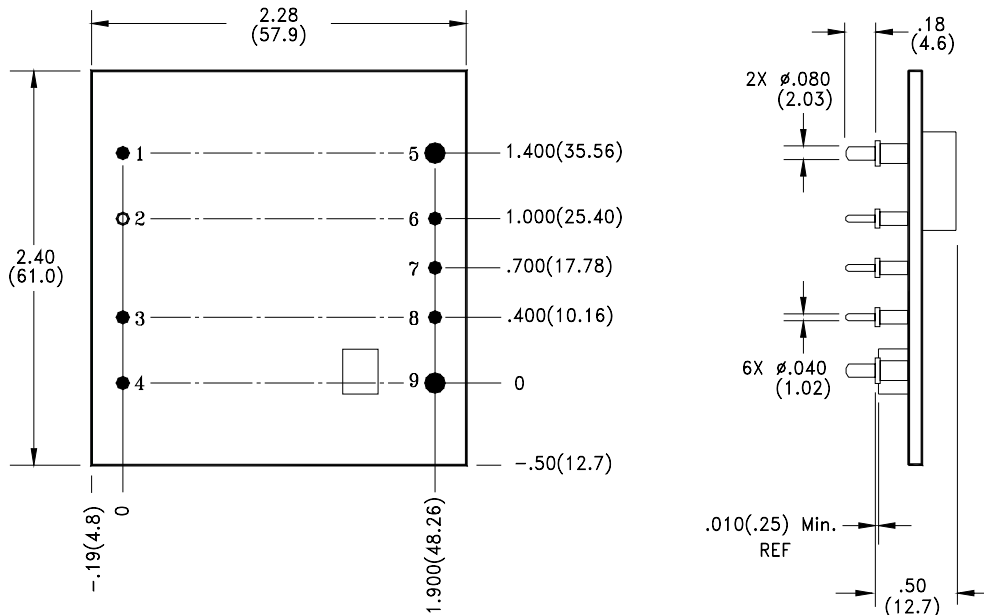

Bottom (Pin-side) View

Mechanical Tolerances:		
General Dimensions	Inches	Millimeters
	X.XX = ±0.020	X.X = ±0.5
	X.XXX = ±0.010	X.XX ±0.25
Pin Diameter	±0.002	±0.05
Pin Length		
0.180" (-xxAx)	+/- .020	±0.5
0.145" (-xxBx)	+/- .020	±0.5
0.110" (-xxCx)	+/- .020	±0.5
Distance from tallest converter component to host board	0.010 MIN	0.25 MIN

Pin Assignments:	Function
1	-Vin
2	No Pin
3	On/Off
4	+Vin
5	-Vout
6	-Sense
7	Trim
8	+Sense
9	+Vout

NUCLEAR AND MEDICAL APPLICATIONS - Power-One products are not designed, intended for use in, or authorized for use as critical components in life support systems, equipment used in hazardous environments, or nuclear control systems without the express written consent of the respective divisional president of Power-One, Inc.

TECHNICAL REVISIONS - The appearance of products, including safety agency certifications pictured on labels, may change depending on the date manufactured. Specifications are subject to change without notice.